



MACSUR and AgMIP jointly present the International Crop Modelling Symposium
**Crop Modelling for Agriculture and Food Security
under Global Change**



ABSTRACTS

Editors

Frank Ewert
Kenneth J. Boote
Reimund P. Rötter
Peter Thorburn
Claas Nendel

Welcome Note	1
Abstracts of Keynote Presentations.....	4
Abstracts of Oral Presentations.....	17
Abstracts of Poster Presentations	184

Welcome

It is with pleasure that we welcome the international crop and agro-ecosystem modelling community and scientists from related disciplines to the International Crop Modelling Symposium 2016, in Berlin.

The past decade has seen a number of research initiatives launched to advance crop modelling and related research. Among these initiatives, The European Knowledge Hub MACSUR (Modelling European Agriculture with Climate Change for Food Security, <http://macsur.eu/>) and the international AgMIP project (Agricultural Model Intercomparison and Improvement Project, <http://www.agmip.org/>) stand out in terms of the breadth of their research scope. A large and important part of the activities in both projects is comprised of the improvement, comparison and application of crop models for climate change impact and risk assessment for food security in Europe (MACSUR) and further (AgMIP). These projects have brought together a large number of scientists from around the world and produced a substantial body of novel results. The international MACSUR symposium on crop modelling in Oslo in 2014 and the annual Global Workshops of AgMIP have provided forums to exchange some of these results and have been initial and important events towards this symposium. The increasing interest from within and beyond the crop modelling community for a more comprehensive forum for the exchange of results ultimately motivated representatives of MACSUR and AgMIP to organise this symposium, reflecting the successful and joint work of both projects including successful interaction with other international networks.

The overwhelming interest in participation in this symposium has exceeded original expectations. From the large number of submitted papers, it was possible to develop what we, the Symposium Chairs, hope is an exciting programme of oral and poster presentations combined with a range of internationally recognised keynote speakers. The workshop structure follows the main activities related to model improvement and model application, as well as anticipating improvements in genetics, and links between crop and related modelling fields such as grassland and vegetation modelling, and

functional structural plant modelling. Accordingly, four sessions have been organised:

- Session 1: Improvement of crop models and modelling approaches
- Session 2: Linking crop models and genetics
- Session 3: Crop modelling for risk/impact assessment
- Session 4: Expanding and supporting modelling activities

The organisation of this symposium was only possible due to the help of several people. Special thanks go to the Session Chairs and the Scientific Committee Members for supporting the development of the symposium programme. We are particularly grateful for the effort of the local host ZALF (Centre for Agricultural Landscape Research) for organising the venue, registration, website and logistics of the programme. The financial and in-kind support from the Research Council of Norway through MACSUR, CSIRO, AgMIP, University of Bonn, Luke and the University of Florida are likewise gratefully acknowledged.

We wish all participants a very fruitful and inspiring symposium and we look forward to the many interesting keynotes, oral and poster presentations. We also hope to have the chance to interact with many of you during the course of the symposium and that the symposium may help to support ongoing and initiate new collaborations to further advance research on crop modelling.

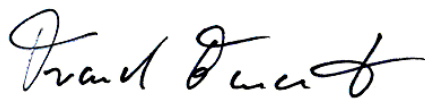

Frank Ewert

On behalf of the Symposium Chairs, Kenneth J Boote, Peter Thorburn and Reimund Rötter, and the local host at ZALF, Claas Nendel.

International Crop Modelling Symposium **iCROPM₂₀₁₆** 15-17 March 2016, Berlin

Abstracts of Keynote Presentations

What does the Paris Agreement mean for crop-climate modelling?

A. Challinor¹

¹ ICAS, School of Earth and Environment, Leeds LS18 5JL. a.j.challinor@leeds.ac.uk

The Paris Agreement achieved at COP21 has reignited scientific interest sub-two degree global mean temperature targets and prompted a need for risk assessments that can differentiate between 1.5 and 2 degrees of global warming. Risks can be defined narrowly as the potential for reduced food production, or broadly as the risk to the food systems that deliver – or fail to deliver – food security. This talk focusses on the role of crop-climate modelling within each of these types of assessment.

Assessments of risk to crop productivity have a relatively long history, and tend to be based on crop-climate modelling (e.g. Challinor *et al.*, 2009). Detecting systematic differences in crops yields at 1.5 vs 2 degrees of warming is difficult because the range of model results is large (Fig. 1). The frameworks used to conceptualise uncertainty underpin the potential for crop-climate modelling to distinguish risks. A critical assessment of these frameworks reveals a number of characteristics that tend to improve risk assessments:

- a. Use of a range of observed data and outputs from crop models, as opposed to only yield (Challinor *et al.*, 2014a, Wesselink *et al.*, 2014).
- b. Data analysis to determine when particular changes will occur, rather than what will occur at any particular time (Vermeulen *et al.*, 2013).
- c. Use of crop-climate models as part of broader assessments of risk (e.g. Ewert *et al.*, 2015). The concept of ‘food system shocks’ has recently been used to capture the impact of major extreme events on global food systems (Lloyds, 2015).

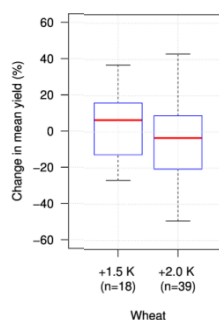

Figure 1. Difference in modelled wheat yields from across the globe for 1.5 and 2 K of global warming. Source: ref. (Challinor *et al.*, 2014b) re-analysed by Julian Ramirez Villegas.

Risk assessment methods such as those outlined above can be used to evaluate the implications of the Paris Agreement. A number of technical challenges will need to be addressed when quantifying future impacts in a way that aligns with policy targets:

- **Understanding the spatial distribution of climate and its impacts for a given change in global mean temperature.** For any given change in global mean temperature there are a range of possible global spatial configurations of temperature change. These interact with land use patterns, which are themselves a source of uncertainty in determining yield responses (Challinor *et al.*, 2015).
- **Detailed understanding of the risk of food system shocks** (Lloyds, 2015) and their implications will require very long (1000+ years) climate model runs in order to capture the statistics adequately.
- **Global-scale impacts and adaptation options need to be assessed alongside global agricultural mitigation options.** Work at the adaptation/mitigation interface (e.g. climate-smart agriculture) is often conducted at relative small scales. The strong mitigation targets presented by the Agreement make global- and regional- scale assessments of this sort particularly important.

Addressing these and other associated challenges will require a plurality of approaches. Critical analysis of the modelling tools available to achieve these technical challenges demonstrates that there is no single approach that can be expected to produce the most robust results. Hence, in order to assess risk and provide societally relevant information we are increasingly required to conduct impacts modelling in novel and diverse ways. Targeted analyses of this sort could profitably focus on identifying which decisions it can affect (Hulme, 2016), perhaps following a similar methodology to the global framework for climate services the might fall under the climate services umbrella (Hewitt *et al.*, 2012).

References

- Challinor A, Martre P, Asseng S, Thornton P, Ewert F (2014a) Making the most of climate impacts ensembles. *Nature Clim. Change*, **4**, 77-80.
- Challinor AJ, Ewert F, Arnold S, Simelton E, Fraser E (2009) Crops and climate change: progress, trends, and challenges in simulating impacts and informing adaptation. *Journal of Experimental Botany*, **60**, 2775-2789.
- Challinor AJ, Parkes B, Ramirez-Villegas J (2015) Crop yield response to climate change varies with cropping intensity. *Global Change Biology*, n/a-n/a.
- Challinor AJ, Watson J, Lobell DB, Howden SM, Smith DR, Chhetri N (2014b) A meta-analysis of crop yield under climate change and adaptation. *Nature Clim. Change*, **4**, 287-291.
- Ewert F, Rotter RP, Bindi M *et al.* (2015) Crop modelling for integrated assessment of risk to food production from climate change. *Environmental Modelling & Software*, **72**, 287-303.
- Hewitt C, Mason S, Walland D (2012) COMMENTARY: The Global Framework for Climate Services. *Nature Climate Change*, **2**, 831-832.
- Hulme M (2016) 1.5 [deg]C and climate research after the Paris Agreement. *Nature Clim. Change*, **6**, 222-224.
- Lloyds (2015) Food System Shock, The insurance impacts of acute disruption to global food supply. *Emerging Risk Report -2015, Innovation Series*, , http://www.lloyds.com/~media/files/news%20and%20insight/risk%20insight/2015/food%20system%20shock/food%20system%20shock_june%202015.pdf, .
- Vermeulen SJ, Challinor AJ, Thornton PK *et al.* (2013) Addressing uncertainty in adaptation planning for agriculture. *Proceedings of the National Academy of Sciences*, **110**, 8357-8362.
- Wesselink A, Challinor A, Watson J *et al.* (2014) Equipped to deal with uncertainty in climate and impacts predictions: lessons from internal peer review. *Climatic Change*, 1-14.

How do we become champions for transforming agri-food systems?

A. Dobermann

Rothamsted Research, Harpenden, Herts AL5 2JQ, UK
E-mail: achim.dobermann@rothamsted.ac.uk

The sustainable intensification of agri-food systems will play a prominent role in the new sustainable development agenda. The big unknown is how to set and achieve concrete, multiple targets associated with the new Sustainable Development Goals (SDGs) and in what order of priority. New technologies should allow engineering transformative changes along the whole food chain and for the growing bioeconomy. However, political, economic and social drivers and constraints often seem to go against enabling faster development and wider adoption of new technologies. Countries and businesses will need to develop suitable roadmaps for achieving specific targets, which also presents new opportunities and challenges for the research community, including modellers. On one hand, models will need to increasingly address whole bioeconomy chains in order to identify the right entry points for technological and other interventions. On the other hand, modelling approaches need to be transparent and simple in order to communicate results and recommendations in the right language and using indicators that are of direct relevance for policy setting and decision making. Agricultural scientists, including modellers, will need to think differently and also change their ways of working in order to meet these new demands and have more impact from their research.

Integrating crop physiology and modelling with genetic improvement

G. Hammer¹ – S. Chapman² – E. van Oosterom¹ – G. Mclean³ – A. Borrell⁴ – D. Jordan⁴

¹ The University of Queensland, Queensland Alliance for Agriculture and Food Innovation, Queensland Bioscience Precinct, 306 Carmody Rd, St Lucia, QLD 4067 Australia, e-mail: g.hammer@uq.edu.au

² CSIRO Agriculture

³ Queensland Department of Agriculture and Fisheries

⁴ The University of Queensland, Queensland Alliance for Agriculture and Food Innovation

The potential to add significant value to the revolution in plant breeding associated with genomic technologies is a new frontier for crop physiology and modelling. Yield advance by genetic improvement continues to require prediction of phenotype based on genotype. Recently, molecular breeding strategies using genome wide prediction and genomic selection approaches have developed rapidly. However, their applicability to complex traits, such as crop yield, remains constrained by gene-gene and gene-environment interactions, which restrict the predictive power of associations of genomic regions with phenotypic responses. Here it is argued that crop ecophysiology and functional whole plant modelling can provide an effective link between molecular and organism scales and enhance molecular breeding by adding value to genetic prediction approaches. Crop physiology and modelling provide opportunities to improve breeding efficiency by either dissecting complex traits to more amenable targets for genetic prediction, or by trait evaluation via phenotypic prediction in target production regions to help prioritise effort and assess breeding strategies (Fig. 1). But this requires a transdisciplinary approach that integrates physiology and modelling into quantitative genetic improvement systems, rather than a model-based focus on ‘genotypic coefficients’ and ‘ideotypes’.

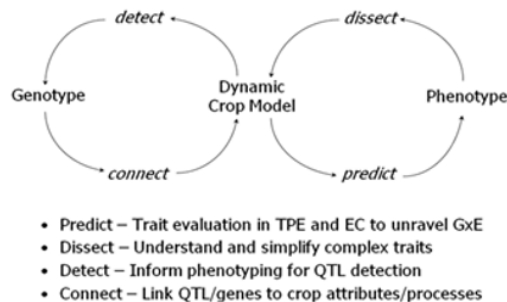

Figure 1. Schematic of transdisciplinary approach to breeding systems highlighting integration and roles of physiology and modelling with genetics (after Messina et al., (2009) and Hammer et al., (2014)).

A dynamic physiological framework that facilitates dissection and modelling of complex traits can inform phenotyping methods for marker/gene detection and underpin prediction of likely phenotypic consequences of trait and genetic variation in target environments. This will require models where capturing biological understanding in a crop growth and development context is as important as the predictive capability of the model – the right answer for the right reason. Models with more robust biological underpinning and the ability to link parameters with the genetic architecture of adaptive traits in a stable manner will come to the fore (Hammer et al., 2010; Boote et al., 2016). Specific examples focussed on drought adaptation (Borrell et al., 2014) are presented here to highlight these concepts.

The putative role of crop modelling as a support technology in plant breeding has been tested intensively over the past decade or two. Crop modelling, utilised in an appropriate manner, has emerged from this process as a useful contributing component of comprehensive plant breeding programs (Messina et al., 2011; Cooper et al., 2014; Hammer et al., 2016). Further advance in the effective application of crop modelling in breeding will undoubtedly occur. As the technology of genomic prediction gains impetus, so will the awareness of the significant value-adding role crop modelling can play in adding biological knowledge to these advanced statistical methods (e.g. Technow et al., 2015). This advance will require attention to underpinning biology in crop models while limiting their complexity, as they strive to make more effective connections between genotype and phenotype than could otherwise occur. The importance of the modelling adage “the right answer for the right reason” and Einstein’s remark of “as simple as possible but no simpler”, will become evident!

Acknowledgements

This research has been variously supported by the Australian Research Council, the Australian Centre for International Agricultural Research, and the Grains Research and Development Corporation.

References

- Boote et al. (2016) In, X. Yin and P. Struik (eds.) *Crop Systems Biology*: Springer. pp. 163-192.
- Borrell, A.K., van Oosterom, E.J., et al (2014) *New Phytologist* 203:817-830.
- Cooper, M., Messina, C.D., Podlich, D., et al. (2014) *Crop and Pasture Science* 65:311-336
- Hammer, G., et al (2016) In, X. Yin and P. Struik (eds.) *Crop Systems Biology*: Springer. pp. 147-162.
- Hammer, G.L., McLean, G., Chapman, S., et al. (2014) *Crop and Pasture Science*, 65: 614–626.
- Hammer, G.L., van Oosterom, E., McLean, G., Chapman, S.C., et al (2010) *J Exp Bot*, 61:2185-2202.
- Messina, C., et al (2009) In, V.O. Sadras and D. Calderini (eds.) *Crop Physiology: Applications for Genetic Improvement and Agronomy*. Academic Press, Elsevier. pp. 235-265.
- Messina, C.D., Podlich, D., Dong, Z., Samples, M. and Cooper, M. (2011) *J Exp Bot* 62: 855–868
- Technow F, Messina CD, Totir LR, Cooper, M (2015) *PLoS ONE* 10(6): e0130855.

Toward a Next Generation of Crop Models

J. W. Jones

University of Florida, Department of Agricultural and Biological Engineering, 289 Rogers Hall, PO Box 110570, Gainesville, FL 32611, USA. E-mail: jimj@ufl.edu

After a number of years during which crop modeling seemed to have plateaued in terms of interest by agricultural scientists and potential users, we have seen a renewed interest in these scientific tools and new approaches being explored in this field that show promise that there is a for a next generation of models. The purpose of this talk is to reflect back on the history of crop modeling to some extent, but focus more on what our scientific community should consider to overcome some of the limitations in existing models and to increase their applicability and confidence in their use by the broader science and user communities. One perspective is that future cropping systems models need to be able to perform virtual experiments for addressing problems and questions and for evaluating alternative production systems as new genetic and management technologies are considered for any production situation in current and future climate conditions. Current models are already being used in some conditions for these types of purposes, including evaluating adaptation options for climate change and for sustainably increasing food production. However, recent research has also shown that there are a number of limitations in existing cropping systems models that limit their applicability for many very important production situations and that large uncertainties exist among models in simulating responses to potential production situations and anticipated future atmospheric CO₂ concentration levels. These limitations and uncertainties have been shown in research recently carried out by groups of crop modelers collaborating in the AgMIP, MACSUR, and other initiatives through comparisons of multiple crop models with high quality datasets from diverse situations (e.g., more than ten and in some studies more than 30 models). These large variations among crop models were found to occur at the potential production level (e.g., responses to temperature and CO₂), even when all other factors were held at their optimum levels and there were no losses due to yield-limiting factors and under water and N limitations.

The presentation will include some thoughts about key changes needed in the agricultural research environment to enable the development of next generation crop models and examples of new capabilities that are needed. For example, I emphasize the fact that the models need to be developed and evaluated using data from a broad range of production environments and management systems if they are to meet expectations and gain credibility for those uses. Broad datasets need to be accessible and usable for evaluating and improving or developing new models; these data will provide a foundation across all disciplines for next generation crop models. Examples of new capabilities include capitalizing on the wealth of molecular genetics data being generated to model plants that help breeders and decision makers select plant and

management technologies for specific production situations and goals, incorporating capabilities to simulate nutrition quality of yield in addition to biomass, incorporating pest and disease damage, and incorporating practical intensive management technologies, such as drip irrigation, slow-release fertilizers, no-till, and others.

Prospects for developing next generation crop models are promising due to recent scientific progress, trends in interest among various users, and new efforts to create open data resources and to change the culture of researchers to enable them to contribute data for broad uses. I am also encouraged by the regional and global projects like MACSUR and AgMIP that have already had major impacts on science that will contribute to next generation models.

Modelling crops and cropping systems – evolving purpose, practice and prospects.

B. Keating¹– P. Thorburn²

¹ CSIRO Agriculture, 306 Carmody Road, St Lucia Qld 4067, Australia.

² Integrated Agricultural Systems, CSIRO Agriculture Brisbane, Queensland 4102, Australia

Cropping systems are characterised by complexity and variability. Complexity arises from inherently complex plant and soil processes combined in an almost infinite set of permutations and combinations and variability associated with biotic and abiotic drivers that are inherently variable in both space and time. This variability is amplified by the management interventions practiced by farmers. Modelling has evolved over the last 70 years as a means of describing and interpreting complex and variable performance and increasingly as a means of predicting likely performance in prescribed circumstances for better decision making.

In this paper we reflect on the evolution of quantitative approaches to describing and predicting crop growth and cropping system performance. We begin with early mathematical descriptions of plant and crop growth and soil processes dating from the 1940's and 50's. We explore the early crop models of the 60's and 70's and the more comprehensive crop-soil models of the 1980's. Cropping systems models with comprehensive systems management capabilities began to gain currency in the 1990s and the ancestry of these models and relationships with broader land systems models examined. Over this long period, the ambitions held by model-makers' for model applications grew and the paper will summarise the very broad range of model applications that have emerged in the early 21st Century from the 60 years of quantitative analysis of crop and cropping systems in the 20th Century.

Throughout this history of model making and application, a creative tension has existed between "statistical" and "mechanistic" approaches to model specification. Statistical approaches have found favour in circumstances where comprehensive data are available to develop robust models useful in a broad range of situations. Mechanistic (or phenomenological) approaches have found favour in situations of sparse data where extrapolation beyond the data available is likely to be more successful. The paper concludes with a look forward – will the rapid developments in sensors, sensor networks, monitoring and the internet of things reduce the historical data constraints that have limited statistical approaches? Will we see more model-data fusion and integration of statistical and mechanistic approaches to model building and application in the decades ahead? What benefits are likely to flow from such trends?

The role of crop modelling in agricultural research

*M. Kropff*¹

¹The International Maize and Wheat Improvement Center (CIMMYT), m.kropff@cgiar.org.

Introduction

Over the last 30 years, modelling has provided fundamental understandings of interactions between plant genotype, environment and management (GxExM), with important implications for future agricultural research, investment and policies.

Uses of crop modelling

Crop models have long been powerful tools in unravelling physiological mechanisms that determine crop yield in relation to the environment. For example, Kropff et al. (1993) showed that nitrogen management was a key limiting factor for high-yielding rice varieties, using a model that explained yield differences reasonably well in terms of radiation, temperature, leaf N content and variety phenology types.

In the context of a global need to improve productivity, yield gap analysis is critical to identify the most important crop, soil and management factors; to effectively prioritize research and interventions; to evaluate the impact of changing circumstances such as climate change or disease; and to provide an agronomic basis to models assessing food security and land use at different spatial scales (Van Ittersum et al. 2013).

For example, Tesfaye et al. (2015) used CERES-Maize to project that in 2080, maize yields in SSA will decrease significantly in two-thirds of current growing areas. Such understanding can be used to recommend adaptation options to farmers, for example conservation agriculture (Ngwira et al. 2014).

Crop modeling of GxExM interactions can suggest potential breeding candidates or ideotypes. Cairns et al. (2013) showed that heat tolerance was at least as important as drought tolerance when breeding for climate change in Sub-Saharan Africa. In another approach, Kholová et al. (2014) virtually introgressed different drought tolerance traits in sorghum, showing how trait and environment interactions condition breeding success. Computer simulation is a powerful tool to help select optimal plant breeding strategies (for an overview, see Li et al. 2012).

Broader Implications

Crop modelling is of great utility in examining hypothetical or projected scenarios, helping build the case for investment in agricultural research and rational policymaking, especially in combination with economic analysis. This is one example of the multidisciplinary collaborations that crop modelling can ultimately facilitate.

Nelson et al. (2009) calculate that a further US \$7 billion per year is needed to offset the impacts of climate change on food security and child health. Chung et al. (2014) showed how a repeat of the 2012 USA heatwave would impact developing world food

security in 2050. In another common application, Negassa et al. (2013) analyzed how rainfed wheat production could increase food self-sufficiency in Sub-Saharan Africa.

Needs

More advanced models are needed to better understand and more precisely represent plant physiology and reactions to abiotic and biotic stresses. Broadly used varieties representing all crop mega environments need to be calibrated and shared with the global community, as well as the definition of virtual varieties to evaluate the value of certain traits to mitigate impact of climate change or biotic stresses.

A robust calculation of yield potential requires data-intensive field trials to calibrate the crop model for each field/year. For yield gap analysis, around 10 to 20 years of daily weather data is needed, along with 10 years of current yield or at least 5 where data is poor (Grassini et al. 2015), preferably sub-national. The lack of reliable yield data, along access to timely climate, soil and other relevant data is a major obstacle.

Given the clear benefits of enhanced use of crop modeling and integration in other research and policy activities, much more investment in modeling approaches and data sets is needed. Such investment would be soon repaid in terms of targeted research for development, increased breeding efficiency, and rational pre-emptive policies.

References

- Cairns, J., Hellin, J., Sonder, K., Araus, J. et al. (2013). Adapting maize production to climate change in sub-Saharan Africa. *Food Security* 5: 345-360.
- Chung, U., Gbegbelegbe, S. et al. (2014). Modeling the effect of a heatwave on maize production in the USA and its implications on food security in the developing world. *Weather and Climate Extremes* 5: 67-77.
- Grassini, P., van Bussel, L., Van Wart, J. et al. (2015) How good is good enough? Data requirements for reliable crop yield simulations and yield-gap analysis. *Field Crops Research* 177: 49-63.
- Kholová, J., Murugesan, T., Kaliamoorthy, S. et al. (2014), Modelling the effect of plant water use traits on yield and staygreen expression in sorghum. *Functional Plant Biology* 41: 1019-1034.
- Kropff, M., Cassman, G., Van Laar, H. and Peng, S. (1993). Nitrogen and yield potential of irrigated rice. *Plant and Soil* 155/156: 391-394.
- Li, X., Zhu, C., et al. (2012). Computer Simulation in Plant Breeding. *Advances in Agronomy* 116: 219-264.
- Negassa, A., Shiferaw, B., Koo, J., et al. (2013). The potential for wheat production in Africa: Analysis of biophysical suitability and economic profitability. CIMMYT.
- Nelson, G., Rosegrant, M., Koo, et al. (2009). Climate Change: impact on Agriculture and Costs of Adaptation. IFPRI Food Policy Report.
- Ngwira, A., Aune, J., Thierfelder, C. (2014). DSSAT modelling of conservation agriculture maize response to climate change in Malawi. *Soil and Tillage Research* 143: 85-94.
- Tesfaye, K., Gbegbelegbe, S., Cairns, J. et al. (2015), Maize systems under climate change in sub-Saharan Africa: Potential impacts on production and food security. *International Journal of Climate Change Strategies and Management* 7(3): 247-271.
- Van Ittersum, M., Cassman, K., Grassini, P. et al. (2013). Yield gap analysis with local to global relevance – A review. *Field Crops Research* 143: 4-17.

Models for crop diseases: an overview of approaches and scales to design a research agenda

S. Savary¹ - L. Amorim² - A. Bergamin Filho² - T. Caffi³ - N. Castilla⁴ - A. Djurle⁵ - P. Esker⁶ - K. Garrett⁷ - N. McRoberts⁸ - V. Rossi³ - A. Sparks⁴ - L. Willocquet¹ - J. Yuen⁵

¹ INRA, UMR Agir Toulouse, France

² ESALq, Universidade de São Paulo, Department of Phytopathology and Nematology

³ Università Cattolica del Sacro Cuore, Istituto di Entomologia e Patologia Vegetale, Piacenza, Italy

⁴ International Rice Research Institute, Plant Breeding, Genetics and Biotechnology Division

⁵ Swedish University of Agricultural Sciences, Department of Forest Mycology and Plant

⁶ University of Costa Rica, Escuela de Agronomía

⁷ University of Florida, Department of Plant Pathology

⁸ University of California Davis, Department of Plant Pathology

Modelling plant diseases has taken many different approaches, partly because of different objectives. Two main objectives of modelling plant disease are: (1) to analyse and understand plant disease epidemics, and (2) to analyse crop losses, both objectives sharing the same ultimate goal of improving disease management. Although the concepts we refer to in this presentation are applicable to any modelling approach, we focus on one category of models only: mechanistic, process-based, simulation models. The concept of damage mechanism has enabled much progress in modelling the effects of multiple harmful organisms on crops (pathogens, animal pests, and weeds). As a result, it is now possible to model yield losses caused by one or multiple injuries in a generic manner (i.e., any crop, any disease/pest). However the availability of injury functions, that is to say, of data representing the time course of diseases (or pests) under actual field conditions, is a major obstacle to the use of such models. This is true even for the main food crops worldwide: rice, wheat, maize, soybean, and potato, for which there is a critical shortage of field data on observed multiple injuries. This shortage of field data – not the limitation of process-knowledge – is the main impediment in modelling crop pests and diseases, and their relations to crops.

A critical step forward is to develop a generic modelling framework for injury functions, which would generate ideotypes of injury time courses, where each ideotype would represent the dynamics of an injury (e.g., of a disease) in reference, key conditions. Crop health in a given context would thus correspond to the collective dynamics of such injury functions, which in turn could be used as drivers for crop loss models.

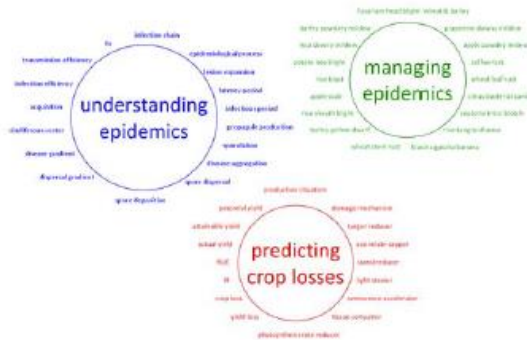

Our emphasis is on generic epidemiological and generic crop loss modelling structures. We provide first a very brief overview of epidemiological modelling, in terms (1) of epidemiological structures (monocyclic; polycyclic; mixed monocyclic-polycyclic; poly-etic), (2) of spatial coverage (explicitly or implicitly spatialized models), and (3) of inclusion of genetic diversity of the pathogen. We then provide a very brief overview of crop loss simulation modelling, with an emphasis on crop (agrophysiological) growth models incorporating damage mechanisms. In this framework, guiding concepts are the levels of yield (potential, attainable, and actual), the factors (defining, limiting, reducing) generating these levels, and a limited series of (seven) damage mechanisms associated with crop diseases and pests. This framework is illustrated by GENEPEST, a general model for generic modelling of yield losses caused by pests and diseases.

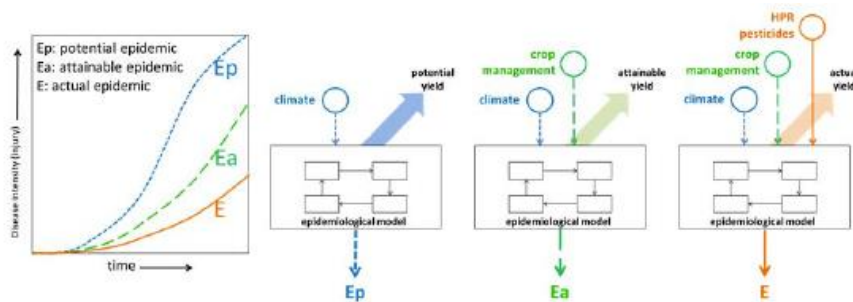

To address the shortage of field data that quantify the dynamics of injury (e.g., disease levels), we present a framework to model the dynamics of epidemics – potential, attainable, actual – which, each in turn, account for the accumulated effects of (1) epidemic defining factors (e.g., climate), (2) epidemic limiting factors (e.g., cropping practices), and (3) epidemic reducing factors (e.g., host plant resistance and chemicals). This framework is designed to be congruent with agrophysiological models. A research agenda for modelling crop diseases includes:

- generic simulation models for disease epidemics;
- focusing on crop health (multiple diseases, pests);
- the development of crop health scenarios (set of injury levels caused by different diseases, pests) and
- which in turn are driving functions for crop growth models, to model crop losses, and gains from management.

A main challenge we put forward is that complicated, sophisticated, models are not required to address crop health – on the contrary: a simple, transparent, and generic structure may contribute much progress towards understanding and management.

Abstracts of Oral Presentations

Linking a phosphorus module to CSM-CERES-Sorghum and evaluating it for West African conditions

M. Adam^{1,2,3,*} – *K. A. Dzotsi*⁴ – *G. Hoogenboom*⁵ – *P. C. S. Traoré*³ – *C. H. Porter*⁴ – *H. F. W. Rattunde*³ – *W. L. Leiser*³ – *E. Weltzien*³ – *J. W. Jones*⁴

^{1,*}International Crop Research Institute for Semi Arid Tropics, Mali, email: myriam.adam@cirad.fr;

² Centre de Coop. Internationale pour la Recherche Agronomique pour le Développement, UMR-AGAP;

³ Institut National de l'Environnement et de Recherches Agricoles, Burkina Faso ;

⁴ University of Florida, USA; ⁵ Washington State University, USA.; * Corresponding author

Introduction

Phosphorus (P) deficiency is a major constraint to sorghum productivity in West Africa with its highly weathered soils. Changes in P management are a much larger determinant of crop performance than climate change in the Sudanian zone, the principal sorghum production zone. The rapid agricultural intensification, decreased or abandoned following, and variable access to and manner of P fertilization in this zone create both challenges and opportunities for farmers keen to increase sorghum productivity. Additionally, P and moisture availability interact with significant effects on plant phenology and growth. Yet in most mechanistic crop models, P has not been included for process simulation. In the Cropping System Model (CSM) of DSSAT (Jones et al., 2003), a soil and plant P module is active for CSM-CERES-Maize (Dzotsi et al., 2014) but not for CSM-CERES-Sorghum or CERES-Millet where it is greatly needed. The aim of this paper is to present the current efforts to develop a P-aware sorghum model within DSSAT (Hoogenboom et al., 2014).

Materials and Methods

To couple the P module to the sorghum CSM model, we first calibrated CSM-CERES-Sorghum for representative West African sorghum genotypes in non P-limiting conditions, then proceeded with key CSM source code modifications to couple the CSM Phosphorus module to CSM-CERES-Sorghum, and finally we establish the P response in selected genotypes from experimental data. For this, we collected data on phosphorus concentration in stems, leaves and grain in sorghum grown in a high and P deficient soils at ICRISAT-Mali on three cultivars of contrasting maturity and photoperiod sensitivity for calibration in DSSAT (PP sensitivities). Plant samples were collected at different crop stages and plant nutrient concentrations were determined. Soil analysis was performed to determine P Bray in soil. Field experiments are also conducted in Burkina Faso to extend the range of environments.

Results and Discussion

The model was first calibrated for three contrasting varieties representing the range of maturities for the West African Sudanian zone (Figure 1) and then coupled to the P module available within the CSM. We performed simulations with low P optimal concentration in plant organs as reported in data from Mali (P-concentration in shoot at mat = 0.89mg/g for CSM355) as well as information on soil-P content and yield re-

sponse to P deficiency from Leiser et al., 2014 on a low-P (4.4 ppm Bray-1) soil with observed yield reductions of 38 to 57 % (all cultivars included). Data of P concentrations are still being collected to test the improved model against sorghum yields observed under high and low soil-P conditions,

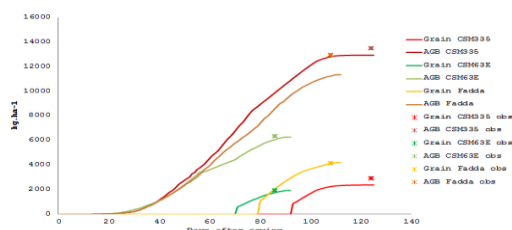

Figure 1. Simulated (lines) and observed (crosses) grain and aboveground biomass (ABG) productivity three contrasting sorghum varieties adapted to West African conditions

The coupling of the DSSAT Phosphorus module to CERES-Sorghum is now functional and we simulated a yield reduction for the sorghum CSM335 (cultivar adapted to the Koutiala, Mali) similar to the one observed by Leiser et al., 2014 (Table 1).

Table 1. Simulation of sorghum yield reduction due to phosphorus (P) deficiency

Grain yield CSM335 (kg/ha)	Simulated	Observed
Sorghum model (without P coupled)	2671	2210 (high P)
Sorghum model (with P coupled)	817	950 (low P)

On-going work is on calibration and evaluation of the P-aware sorghum model with P concentration data collected in Mali and Burkina Faso (2014-2015). Results of this work will be presented at the conference.

Conclusions

We achieved the technical coupling of the P module with the sorghum model in DSSAT-CSM, calibrated for Malian conditions. We are currently collecting P concentration data to calibrate and evaluate the P model and using the new data for additional evaluation. Further, we plan to improve the DSSAT sorghum model for leaf area dynamics and carbon partitioning.

Acknowledgements

This work was undertaken as part of, and funded by, the CGIAR Research Program on Dryland Systems led by the International Center for Agricultural Research in the Dry Areas (ICARDA).

References

- Dzotsi K.A., J.W. Jones, S.G.K. Adiku, J.B. Naab, U. Singh, C.H. Porter, A.J. Gijsman. (2010). Ecological Modelling, 221: 23, 24 p.2839-2849
- Leiser WL, Rattunde HFW, Weltzien E, Haussmann BIG.(2014). Plant and Soil,377, p.383-394
- Hoogenboom, G., J.W. Jones, P.W. Wilkens, C.H. Porter, K.J. Boote, L.A. Hunt, U. Singh, J.I. Lizaso, J.W. White, O. Uryasev, R. Ogoshi, J. Koo, V. Shelia, and G.Y. Tsuji. (2014). (www.DSSAT.net).
- Jones, J.W., G. Hoogenboom, C.H. Porter, K.J. Boote, W.D. Batchelor, L.A. Hunt, P.W. Wilkens, U. Singh, A.J. Gijsman, and J.T. Ritchie. (2003). EJA:235-265.

Simulating the impact of source-sink manipulations in wheat

S. Asseng¹ – B. T. Kassie¹ – M. H. Labra^{2,3} – C. Amador^{2,4} – D. F. Calderini²

¹ Department of Agricultural and Biological Engineering, University of Florida, Gainesville, FL 32611-0570

² Universidad Austral de Chile, Institute of Plant Production and Protection, Campus Isla Teja, Valdivia, Chile

³ present address: Wageningen University, Centre for Crop Systems Analysis, P.O. Box 430, 6700 AK Wageningen, The Netherlands

⁴ present address: Universidad Nacional de Agricultura, Catacamas, Olancho, Honduras

Introduction

Increasing wheat productivity is needed to feed the growing world population, which is projected to be over 9 billion by 2050 (Godfray, 2014). This aim is especially challenging because even maintaining wheat production in some regions will be difficult due to rising temperature (Asseng et al., 2015; Lobell et al., 2012) and decreasing solar radiation (Yang et al., 2013). The next quantum leap in grain yield of wheat should be driven by higher biomass production together with optimizing the source-sink ratio. In this context, source refers to photosynthetic activity of green leaves including formation, remobilization and partitioning of photosynthetic products and sink refers to the growing capacity of organs (e.g. grain number and grain size) to accumulate assimilates).

Recently, there have been questions regarding the capability of crop models to simulate the physiology of source-sink interactions in crops; however, crop models have never been tested with source-sink manipulated data. In this study, we tested the APSIM-Nwheat model with detailed measured field experimental data with treatments of manipulated source (i.e. photosynthetic capacity) and sink (i.e. grain number and size) and combinations among them.

Materials and Methods

Two field experiments were conducted at the experimental station of Universidad Austral de Chile in Valdivia (39° 38' S, 73° 5' W), Chile, during the growing seasons of 2004-2007. Experiment 1 consisted of three source-sink treatments: (i) control without manipulation, (ii) reduction of the source-sink ratio by shading the crop between booting and anthesis with nets intercepting 50 % of the incoming radiation and (iii) increase of the source-sink ratio by halving spikes 10 days after anthesis in both treatments (i) and (ii). This experiment also includes a sink and source limitation experiment using a 7 % increase in RUE with no shading treatments. Experiment 2 consisted of: (i) control without manipulation, (ii) shading with nets intercepting 50 % between 10 days after anthesis to maturity and (iii) shading with nets intercepting 90 % of the incident solar radiation during the same period. APSIM-Nwheat model was calibrated and run with experiment-specific weather and crop management input combinations. Simulated crop growth parameters (mainly grain yield and total above ground biomass) data were then compared against the field experiment data.

Results and discussion

APSIM-Nwheat model reproduced observed effects of shading before and after anthesis as well as the additional impact of halving the spikes. A 90 % shading during grain filling reduced individual grain weights drastically with the remaining yield mostly determined by carbohydrate remobilisation, which was reproduced by the model. The model reproduced the positive impact of a 7 % genetically increased radiation use efficiency (RUE) on growth and yield. A sensitivity analysis indicated that the yield response to increased RUE can vary among environments. The yield impact can be positive in many environments, but negative in terminal drought environments, where stimulated early growth from higher RUE can cause accelerated water deficit during grain filling and reduced yields.

The adequate simulations of sources and sinks are critical for estimating crop-environmental interactions affecting photosynthetic capacity, including breeding and industrialisation-induced effects. This is supported by the urgent need of evaluating geo-engineered solar dimming and genetically and atmospheric CO₂ increased RUE. There is also a need to improve capability of crop models to account for the source-sink balance in different scenarios like biomass improvement by wheat breeding and, on the other hand, biomass decrease as effect of pests and disease, which may be critical with climate change for accurate simulation of sink-source interactions.

Conclusions

The study presented here demonstrated that crop models such as the Nwheat, which accounts for the direct and indirect effect of variations in solar radiation, can be useful for studying the impacts of changes in solar radiation on physiological mechanisms of sink-source interactions and their effects on crop growth and productivity.

Acknowledgements

This research was financially supported by the International Food Policy Research Institute (IFPRI) and by Fundación Andes, Project C-13855 (8), Fortalecimiento de la Docencia e Investigación en Universidades Regionales competitive grant (Chile).

References

- Asseng S. et al., (2015) Rising temperatures reduce global wheat production. *Nature Climate Change* 5:143-147.
- Godfray H.C.J. (2014) The challenge of feeding 9-10 billion people equitably and sustainably. *Journal of Agricultural Science* 152:S2-S8.
- Lobell D.B., A. Sibley., J. Ivan Ortiz-Monasterio. (2012) Extreme heat effects on wheat senescence in India. *Nature Climate Change* 2:186-189.
- Yang X., S. Asseng; M.T.F. Wong; J. Li; Q. Yu; E. Liu (2013) Quantifying the interactive impacts of global dimming and warming on wheat yield and water use in China. *Agricultural and Forest Meteorology* 182:342-351.

Risk analysis and yield potential of dry seeded rice in Bihar, India

*Balwinder-Singh*¹ – A. J. McDonald² – V. Kumar³ – A. K. Srivastava¹

¹ CIMMYT, New Delhi, India, (balwinder.singh@cgiar.org), (A.srivastava@cgiar.org)

² CIMMYT, Kathmandu, Nepal (A.McDonald@cgiar.org)

³ IRRI, DAPO 7777, Metro Manila, Philippines (virender.kumar@irri.org)

Introduction

Rice production systems in the eastern Indo-Gangetic Plains (EIGP) of South Asia have low productivity due to insufficient input use, late planting, and periodic rainfall deficits coupled with low levels of investment in irrigation (Cornish et al., 2015). Farmers generally grow long duration rice varieties in rainfed conditions, late monsoon onset and labour scarcity delays rice establishment and harvest, resulting in yield loss of both rice and next crops due to subsequent delayed sowing of the second crop in the rotation. By taking advantage of pre-monsoon showers, timely rice establishment can be achieved by dry seeding on non-puddled soil (dry seeded rice, DSR). DSR establishment generally has a much lower irrigation requirement than transplanted rice (Kumar and Ladha, 2011). Nevertheless, DSR crop establishment fails when inundating rains occur shortly after planting. Early establishment of DSR reduces the risk of crop failure from rainfall inundation, but may reduce crop yields (e.g. low solar radiation during grain filling) while increasing crop water requirements. By assessing these trade-offs, resource requirements, and risks, this study endeavours to identify optimal timing of establishment for DSR in EIGP, thereby identifying strategies for enhancing system-level productivity and performance stability in rice-wheat systems.

Materials and methods

The APSIM model was parameterized and validated for the long duration (150 d) rice variety (MTU7029) grown at Patna, in central Bihar on a silt loam soil. Using historical weather data (1970-2010), the validated model was used to evaluate 15 DSR sowing windows staggered at 7-d intervals starting from 1 May, each sowing window ended on 31 August. In each sowing window sowing was done only when soil moisture (in 0-15 cm) was 40-80 % of field capacity. Five irrigation schedules were evaluated as risk minimizing strategies: I1 rainfed, I2 one early irrigation (at 20kPa soil tension), I3 two irrigations (as for I2 plus one at panicle initiation), I4 three irrigations (as for I3 plus one at flowering), and I5 irrigation whenever soil tension exceeded 20kPa. Comparisons of sowing and irrigation strategies were made in terms of probabilities of being able to sow during the target window, yield, and irrigation water requirement.

Results and Discussion

Under rainfed conditions, there was high variability across years for DSR sowing date, for example, in S3 (sowing start from 15 May), sowing date ranging from 16 May to 10 August (median of 31 May) (Figure 1a). The range reflects the variability in the onset of

the monsoon. Sowing date variability decreased in later sowings because of the high probability of the soil being too wet to sow. In sowing windows starting from 1 May to mid-June, all sowing occurred in the first fortnight of June because soil was too dry to before this window, and too wet after it. Rice grain yield was higher in mid-May to mid-June sowings, (around 2 t ha⁻¹) (Figure 1b). Yield dropped rapidly for sowing window start in late-June to very low values for all later sowing windows, due to terminal drought and low temperature stress. Yields were increased by an average of 2 t ha⁻¹ in 5 June sowing window under I2 irrigation treatment. (Figure 2a), as one irrigation was enough for the crop to survive the dry period before the rains started. Yields were more stable and higher with increase in irrigation frequency. With full irrigation (I5), yield averaged 6 t ha⁻¹ with an average of 6 irrigations (range 3 to 11) (Figure 2).

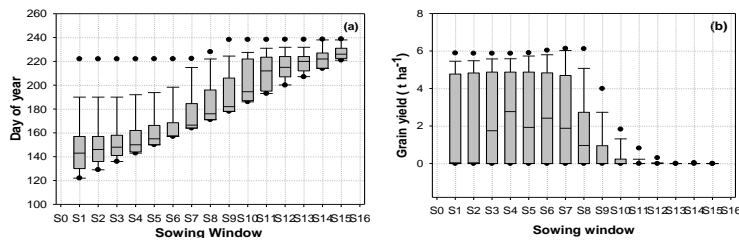

Figure 1. Sowing date (a) and rice grain yield (b) under different sowing windows. Vertical shaded bars are 25th-75th percentiles; whisker caps are 10th and 90th percentiles and black dots 5th and 95th percentiles. Sowing window start dates are 1 May (S1), 8 May (S2), 15 May (S3), 22 May (S4), 29 May (S5), 5 June (S6), 12 June (S7), 19 June (S8), 26 June (S9), 3 July (S10), 10 July (S11), 17 July (S12), 24 July (S13), 31 July (S14), 7 August (S15).

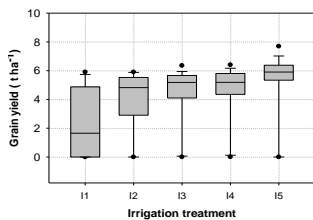

Figure 2. The effect of irrigation treatments (I1-I5) on probability of rainfed DSR grain yield (t ha⁻¹). Vertical shaded bars are 25th-75th percentiles; whisker caps are 10th and 90th percentile and black dots 5th and 95th percentile over 41 years (1970-2010).

Conclusions

The optimum sowing time for establishment and yield of rainfed DSR in Patna is early to mid-June, with mean yield of ~2 t ha⁻¹. The risk of crop failure can be greatly reduced with early sowing (around 15 June) with supplementary irrigation, while increasing yield by about 2 t ha⁻¹ with only one early irrigation.

References

- Cornish, P.S., Dinabandhu Karmakar, Ashok Kumar, et al., (2015) Field Crops Research, 137: 166-179
 Virender Kumar and Ladha, J.K. (2011) Advances in Agronomy, 111: 297-403

A wheat model with detailed account of C and N metabolism

R. Barillot¹ – C. Chambon¹ – B. Andrieu¹

¹ UMR ECOSYS, INRA, 78850 Thiverval-Grignon, bruno.andrieu@grignon.inra.fr

Introduction

Improving crops requires to better link traits and metabolic processes to whole plant performance. We present CN-Wheat model that provides a comprehensive and mechanistic representation of carbon (C) and nitrogen (N) metabolism within a wheat culm during grain filling.

Materials and Methods

Culm structure is composed of a root compartment, a set of photosynthetic organs and the grains. Each module includes structural, storage and mobile materials. Fluxes of C and N among modules take place through the communication with a common pool and/or through the transpiration flow. Physiological activities modelled are the acquisition of C and N, the synthesis and degradation of primary metabolites (sucrose, fructans, starch, amino acids, proteins, nitrate), and C loss by respiration, exudation and tissue death. Assimilation of C is calculated using Farquhar model applied at organ scale with parameter dependency to tissue N (Braune et al., 2009). Nitrogen uptake is modelled as the resultant of activities of HATS and LATS systems regulated by root concentrations in nitrate and sucrose. A central role is given to metabolite concentrations, as drivers of physiological activities through Michaelis-Menten equations and as driver of transfers between organs through resistance analogy. Finally the plant functioning is represented as a set of differential equations. The model is initialized at flowering and simulates the post flowering stage with a time step of 1 hour. To evaluate overall consistency, we estimated model parameters by compiling various bibliographic sources, so that they do not represent a specific genotype but represent plausible values.

Results and Discussion

We illustrate model behaviour by simulating the grain filling period for two contrasted treatments corresponding to no fertilisation (H0) at flowering and 15 kg N/ha (H15) brought at flowering (Bertheloot et al., 2011). Figure 1 shows the dynamics of non-structural C and N in the main plant parts. Stem and laminae accumulated large amounts of non-structural C until the rapid growth of grains triggered the remobilisation. Diurnal variations of C were observed for laminae due to the balance between daily sucrose accumulation and the phloem loading. These variations were less pronounced for stem that mainly accumulated storage forms of C such as fructans. Non-structural C in laminae and stem decreased faster for H0 than H15 due to the early decrease of leaf protein in H0, triggering leaf senescence, while leaf in N15 accumulated N until 600 hours post-flowering. The N treatments induced contrasted dynamics of

root non-structural N. The shortage lack of N in H0 roots resulted in a decrease of organic N synthesis that therefore reduced the consumption of C, which explains the larger accumulation of C in H0 roots than for H15. Finally, the shorter live span of photosynthetic tissue in NO treatment resulted in a less acquisition of C and a grain dry mass lower of 0.5 g compared to H15. Similarly, the lower N availability impacted N accumulation in grains which reached 27mg in H0 vs 33 mg in H15.

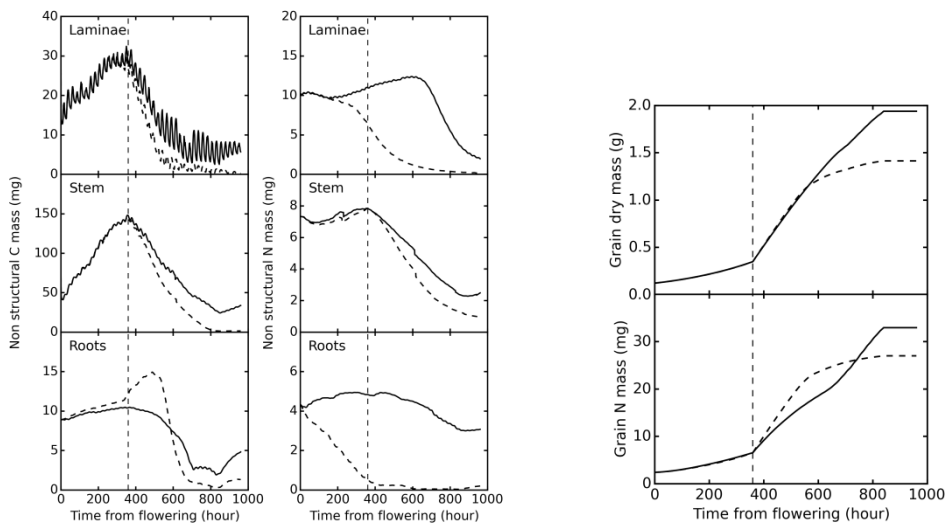

Figure 1. Dynamics of non-structural C and N (a) and dynamics of total C and N in grains (b), simulated for H0 (dashed line) and H15 (solid line) treatments. Vertical line shows the start of fast grain filling.

Conclusions

Modelling the functions based on an explicit description of the pools of metabolites provided original insights on the interactions that take place within the plant. We expect that this approach will strengthen our capacity to integrate in plant and crop models the knowledge in physiology and investigate plant traits adapted to changes in practices or environmental conditions.

Acknowledgements

The model is developed within the frame of the “Investissements d’Avenir” Breedwheat Project

References

- Bertheloot, J., Q. Wu, P.-H. Cournède et al., (2011). *Annals of Botany*, 108: 1097-1109.
 Braune, H., J. Müller, and W. Diepenbrock. (2009). *Ecological Modelling*, 220:1599-1612.

Handling uncertainties with multi-ensemble and multi-model simulations in the LandCaRe-DSS

M. Berg¹ – W. Mirschel¹, B. Köstner²

¹ Institute for Landscape Systems Analysis, Leibniz-Centre for Agricultural Landscape Research (ZALF), Eberswalder Str. 84, 15374 Müncheberg, Germany, e-mail: michael.berg@zalf.de

² Chair of Meteorology, TU Dresden

Introduction

The LandCaRe-DSS (Wenkel et al., 2013) is a model-based decision support system for impact assessment and adaptation strategy development of agriculture to climate and land use changes, designed to offer a reasonable easy way to explore this complex problem space in an interactive and dynamic manner. It offers access to a multitude of different climate simulations, different sets of geographical raster data, soil profile data and a range of included statistical and process-oriented models to simulate crop yields, soil-processes and landscape indicators like erosion risk etc. The whole system is easily extensible in all these aspects and tries hard to make them transparent for the average user of the system. As a result of the framework like character of the LandCaRe-DSS, multi-ensemble and multi-model simulations are supported and due to their ever growing need especially the use of multiple climate ensembles has been made easy. Model results are presented to the end user geo-located, for instance as overlay maps, and the LandCaRe-DSS aggregates multiple runs to visualize climate data dependent uncertainties in histograms and box-plots.

Materials and Methods

The LandCaRe-DSS has two ways to handle the uncertainties inherent in climate data and different models treating the same state variables. The first way is to simply run models for different sets of climate realizations, aggregating the results and giving the end user result visualizations containing for instance the average value plus the standard deviation of a particular variable, e.g. crop yield. This process is completely transparent to the user, as she might simply choose a predefined climate simulation and after running a model just has to interpret the results with the attached uncertainty information. Even though an end user might not be aware of the parts that make up a multi-ensemble simulation, a scientist or an advanced user can easily define which climate realizations a single climate simulation is comprised of or even define virtual climate simulations, creating real ensembles, by choosing realizations of different climate simulations and scenarios. The other way to treat uncertainties is more involved and directed at the scientific use case. Here the LandCaRe-DSS is used to run possibly multiple models (for the same state variables, e.g. crop yield from the process-based MONICA model (Nendel et al., 2011) and the statistical hybrid-model YIELDSTAT (Mirschel et al., 2014)) using possibly different climate simulations. The results of these multi-ensemble multi-model runs are stored into model-specific local SQLite databases

and standard post-processing methods are used to extract and interpret the results according to the requirements. The LandCaRe-DSS displays results in two broad categories, as map overlays for model simulations running in whole regions and as a column visualization for point models. For both visualizations there are diagrams available containing further statistical information. In the case of regional results usually four diagrams are displayed, a box-plot and histogram of the spatial distribution of the average result map being displayed and a box-plot and histogram of the yearly spatial averages of the used climate realizations in the present model run (see YIELDSTAT in figure 1, right). In the case of point results at the local scale, every column displays the average value of the according state variable and upon hovering with the computer mouse over the mark representing the value, a rectangle will appear visualizing the standard deviation of all involved values. In the case of the MONICA model further diagrams are available visualizing for instance the yearly dynamics of ground water recharge or the soil organic carbon, where possible including uncertainty bands showing the standard deviation of the aggregated values (see MONICA in figure 1, left).

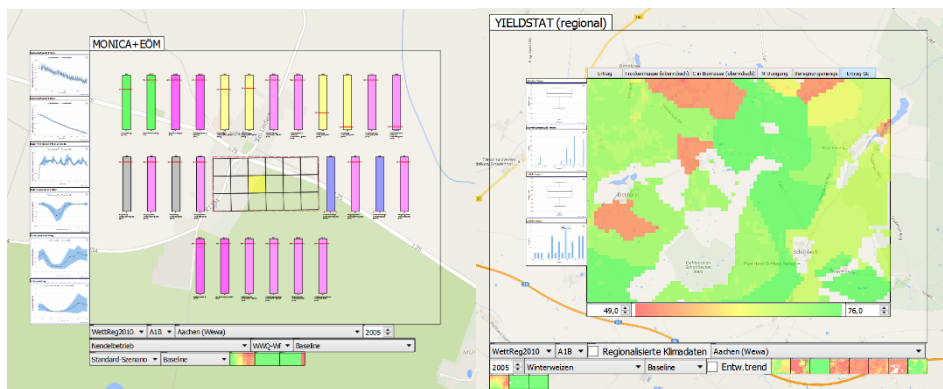

Figure 1. Left: MONICA model displaying results of single run at local scale
Right: YIELDSTAT model displaying winter wheat yields in a region

Acknowledgements

The development of the LandCaRe-DSS was funded by the German Federal Ministry of Education and Research (BMBF) within the klimazwei research program (grant: 01 LS 05109) and the Ministry of Infrastructure and Agriculture of the Federal State of Brandenburg (Germany).

References

- Mirschel, W., R. Wieland, K.-O. Wenkel, C. Nendel, C. Guddat (2014). YIELDSTAT - a spatial yield model for agricultural crops. *European Journal of Agronomy* 52: 33-46.
- Nendel, C., M. Berg, K.C. Kersebaum, W. Mirschel, X. Specka, M. Wegehenkel, K.-O. Wenkel, R. Wieland (2011). The MONICA model: Testing predictability for crop growth, soil moisture and nitrogen dynamics. *Ecological Modelling* 222: 1614-1625.
- Wenkel, K.-O., M. Berg, W. Mirschel, R. Wieland, C. Nendel, B. Köstner (2013). LandCaRe DSS – An interactive decision support system for climate change impact assessment and the analysis of potential agricultural land use adaptation strategies. *Journal of Environmental Management* 127, Supplement, S168-S183.

Modeling sensitivity of grain yield to elevated temperature in the DSSAT crop models for peanut, soybean, bean, chickpea, sorghum, and millet.

K. J. Boote¹ – V. Prasad² – L. H. Allen³ – J. W. Jones⁴ – P. Sing⁵

¹ Agronomy Dept., Univ. of Florida, Gainesville, FL 32611-0500, e-mail: kjboote@ufl.edu, corresponding

² Agronomy Dept., Kansas State University

³ Retired USDA-ARS, Gainesville, FL

⁴ Agric. & Biol. Engr. Dept., Univ. of Florida

⁵ Retired ICRISAT, Consultant, Hyderabad, India

Introduction

Crop models are increasingly being used to predict the potential impact of climate change. Rising temperature is the most detrimental factor to future production for a wide range of crops (Boote et al., 2005). As temperature rises above optimum, yield is first reduced by a shortening of seed-filling phase along with lesser assimilation. As temperature increases further, pollination and fertility increasingly fail and seed growth rate is reduced to the point where grain yield, harvest index, and seed number are zero for peanut (Prasad et al., 2003), soybean (Boote et al., 2005), dry bean (Prasad et al., 2002), and sorghum (Prasad et al., 2006). The objective of this paper is to describe the parameterization of elevated temperature effects on reproductive processes in six crops modelled within the DSSAT: peanut, soybean, dry bean, chickpea, sorghum, and millet, with emphasis on source of experimental evidence for elevated temperature effects relative to the impact on production in different regions.

Materials and Methods

The CROPGRO legume models for peanut, soybean, dry bean, and chickpea, along with CERES-Sorghum and Millet are part of the DSSAT (Jones et al., 2003). The models were evaluated against data on grain yield, grain size, grain number, seed harvest index (HI), and biomass collected in sunlit, controlled-environment chambers, at temperatures ranging from optimum up to the point at which yield, grain-set, and HI failed. Model simulations were conducted for the controlled temperatures and environmental conditions to evaluate the correctness of the simulated response to temperature. Modifications of various functions were made to improve the simulated responses. For CROPGRO legumes, there are three relevant temperature-dependent functions: 1) rate of seed-set, 2) rate of individual seed growth, 3) intensity of partitioning to seed-plus-pod (reproductive). The first two are parabolic functions (upper T_{opt} and T_{fail}) while the partitioning function is a linear look-up with a T_{opt} and T_{max} (at which partitioning is some reduced value). The CERES sorghum and millet models have temperature effects on rate of single seed growth, RGFIL, a linear lookup between T_{opt} and T_{fail} , which were modified in this work. CERES-millet was recently modified to add an effect on grain-set (RGSET), but that feature is lacking in the sorghum model.

Results and Discussion

Simulations of peanut pod yield were compared to data of Prasad et al., (2003). Model predictions were sufficiently close that no modifications were made in the functions, although upper threshold values should be made less sensitive. For soybean, the simulations were close to our data and no modifications were made in the functions. Both legumes share the same temperature functions (Table 1) for seed addition and seed filling rate, based on studies of Egli and Wardlaw (1980). Dry bean simulations were compared to data of Prasad et al., (2002). While the temperature functions for seed-set and seed-growth-rate were satisfactory, the temperature function for leaf photosynthesis had to be pushed higher, T_{opt2} from 31 to 34°C and T_{fail} from 36 to 42°C (rate of 0.0). Many temperature functions for the cool season chickpea model were extensively recalibrated by Singh et al., (2014a), where the upper limit of temperature functions for seed-set, seed-growth rate, and partitioning was based on studies of Wang et al., (2006). For the CERES-Sorghum model, Singh et al., (2014b) re-calibrated the RGFIL (rate of single grain growth) function to the sorghum yield, HI, and grain size measurements of Prasad et al., (2006). For the CERES-Millet model, we modified the RGFIL function (as shown in Table 1), and added a new function (RGSET) to reduce grain-set at high temperature based on Gupta et al., (2015).

Table 1. Cardinal upper temperatures (°C) for seed-set and seed growth rate in DSSAT models. Shapes are parabolic for the legumes and linear lookups for the two cereals.

Function	Peanut	Soybean	Drybean	Chickpea	Sorghum	Millet
Seed-set - T_{opt}	26.5	26.5	25.0	21.0	----	33.0
Seed-set - T_{fail}	40.0	40.0	36.0	33.0	----	39.0
Seed GR. - T_{opt}	23.5	23.5	25.0	20.0	27.0	27.0
Seed GR. - T_{fail}	41.0	41.0	38.0	35.0	35.0	60.0

Conclusions

These adaptations were used to simulate climate change effects on virtual cultivars of peanut (Singh et al., 2013), chickpea (Singh et al., 2014a), sorghum (Singh et al., 2014b), and millet. Heat tolerant cultivars were assumed to be 2 °C more tolerant for T_{opt} and T_{fail} than shown in Table 1, and that degree of heat tolerance was shown to increase yield in many warm regions.

References

- Boote, K. J., L. H. Allen, P. V. V. Prasad, et al., (2005). *J. Agric. Meteorol.* 60:469-474.
 Egli, D. B, and I. F. Wardlaw. (1980) *Agron. J.* 72:560–564.
 Gupta, S. K., K. N. Rai, P. Singh et al., (2015). *Field Crops Res.* 171:41–53.
 Jones, J. W., G. Hoogenboom, C. H. Porter, et al., (2003). *Europ. J. Agronomy* 18:235-265.
 Prasad, P.V.V., K.J. Boote, L.H. Allen, Jr., et al., (2002). *Global Change Biol.* 8:710-721.
 Prasad, P. V. V., K. J. Boote, L. H. Allen, Jr., et al., (2003). *Global Change Biology* 9:1775-1787.
 Prasad, P. V. V., K. J. Boote, and L. H. Allen, Jr. (2006). *Agric and For. Met.* 139:237-251.
 Singh, P., S. Nedumaran, K. J. Boote et al., (2014a). *Europ. J. Agronomy* 52:123-137.
 Singh, P., S. Nedumaran, B. R. Ntare et al., (2013). *Mitig. Adapt. Strateg. Glob. Change* 19:509-529.
 Singh, P., S. Nedumaran, P. C. S. Traore, et al., (2014b). *Agr. & Forest Met.* 185:37-48.
 Wang, J., Y. T. Gan, F. Clarke, and C. L. McDonald. (2006). *Crop Sci.* 46:2171–2178.

APSIM next generation, an improved environment for crop model development

H. Brown¹ – D. Holzworth² – N. Huth² – A. Doherty³ – E. Teixeira¹

¹ New Zealand Institute for Plant and Food Research, hamish.brown@plantandfood.co.nz

² CSIRO Agriculture, Australia

³ University of Queensland, Australia

The number of crop model users is increasing over a wide range of applications. However, the number of scientists who are capable of building and improving crop models remains comparatively small. More efficient methods are required to help developers keep up with the demands for producing good crop models. APSIM Next Generation (referred to as APSIM in this manuscript) uses modern software approaches to provide an efficient and effective environment for the development and deployment of models of farm system components, including crop models. This paper will describe some of these approaches as related to crop models.

To be considered good, a crop model should be:

- **Accurate**, proven by validation across a wide range of situations.
- **Documented** so that users and critics can understand its inner workings.
- **Reliable**, able to reproduce results on an ongoing basis
- **Adaptable**, able to incorporate software and science advances.
- **Available** to and easily updated by a wide range of users.

Achievement of these criteria is difficult and requires expertise from both software programmers and crop physiologists. Generally this has been achieved by combining a multitude of tools and approaches. This makes the process of crop model development slow and often some of the above requirements are not fully met. APSIM aims to aggregate the tools needed to produce good crop models into a single code base accessible through a single user interface to accelerate crop model development.

Developing **accurate** models requires these steps. 1. Collate crop data, 2. Abstract a model to represent the crop, 3. Implement the model into code, 4. Set up simulations representing the observed situations, 5. Run the model, 6. Compare predictions with observations, 7. Adapt model and repeat steps 5, 6 and 7 until the model is accurate. The APSIM user interface provides a visual interface for the plant modeling framework (Brown et al., 2014) allowing crop models to be built by dragging and dropping components rather than writing code. The APSIM user interface also enables the building and running of simulations, collation of observed data and comparison (graphical and statistical) with model predictions (Holzworth et al., 2015). Any model variable can be output and compared with observations either as time course or observed/predicted graphs and comparisons can be aggregated at different levels (treatment, experiment, location, all simulation etc), enabling both detailed and broad assessment of the models performance. This enables steps 3 through 7 to be done visually in a single user

interface, resulting in a file that contains an executable and viewable validation of the model. A change can be made, the model rerun and the outcome of the change accessed within a minute or two. This process of rapid implementation and review of changes has expedited the development of the first few models in APSIM Next Generation and this simpler process for setting up and visualizing model results facilitates wider and more robust validation..

APSIM contains an integrated **Documentation** system to facilitate the production of accurate, complete and up-to-date documentation of all models. An automatically generated pdf document describing each model is produced with each revision of APSIM. These documents are constructed by firstly interrogating the source code (using reflection) and parameters, before creating a full description of all elements of the model. Memo fields are included in the model description to document the rationale for each parameter value and these are included in the documentation. The validation file is then interrogated. It contains memo tags describing each of the experiments that are simulated and the documentation includes these along with graphs and statistics of model performance.

APSIM uses a comprehensive version control (Git) and testing system to ensure the **Reliability** of models. All released models require a validation set and the statistics from this become a base-line against which the model is tested every time any changes are merged into the master branch of the APSIM repository. If the changes result in a deterioration of the performance of any model the merge will fail and model reliability is ensured. This testing system also helps ensure the **Adaptability** of models as changes can be made to both the underlying code and the model structure and the impact of these changes can be readily assessed. This encourages the inclusion of improvements as their impact on the system can be readily assessed.

APSIM is **Available** to anyone for non commercial use at (www.apsim.info). It is installed by downloading and running an installation file. A continuous integration system allows developers to fix defects and make them available to users via the update button in the user interface. As such, releases are no longer done; instead users can choose a release cycle that suits their needs.

References

- Brown, H.E., Huth, N.I., Holzworth, D.P., Teixeira, E.I., Zyskowski, R.F., Hargreaves, J.N.G, Moot, D.J. (2014). Plant Modelling Framework: Software for building and running crop models on the APSIM platform. *Environmental Modelling & Software*, 62: 385-398.
- Holzworth, D., Huth, N. I., Fainges, J., Herrmann, N. I., Zurcher, E., Brown, H.E., Snow, V., Verrall, S., Cichota, R., Doherty, A., deVoil, P., McLean G. and Brider J.. (In press) APSIM Next Generation: The final frontier? MODSIM2015, 21st International Congress on Modelling and Simulation. Gold Coast, Australia. December 2015.

Simulating the effects of water stress on grassland dynamics – a challenge for current grassland models

P. Calanca^{1,*} – *M. Meisser*² – *Z. Vuffray*² – *C. Deléglise*² – *E. Mosimann*²

¹ Climate and Air Pollution, Institute for Sustainability Sciences, Agroscope, Reckenholzstr. 191, CH-8046 Zurich, Switzerland, e-mail: pierluigi.calanca@agroscope.admin.ch

² Pastoral Systems, Institute for Livestock Sciences, Agroscope, Route de Duillier 50, CH-1260 Nyon, Switzerland

* Corresponding author

Introduction

Grasslands cover the majority of the world's agricultural area and provide the feedstock for animal production (Whitehead, 1995). Assessing their response to climate change and shift in the occurrence of extreme events is of paramount importance for securing grassland functioning and productivity. Grassland models can help identifying crucial aspects and therefore understanding grassland dynamics under altered environmental conditions.

Grasslands are particularly sensitive to water stress (Knapp et al., 2001). While to some extent grassland models are able to account for the effects of drought on productivity, in general their performance is far from being satisfactory. The purpose of this contribution is to review existing problems and discuss possible solutions.

Materials and Methods

We examine the performance of two state-of-the-art grassland models in simulating the effects of summer drought on herbage production. Results of recent field experiments conducted in Switzerland (Ammann et al., 2009; Deléglise et al., 2015; Meisser et al., 2015) and related monitoring activities (Mosimann et al., 2012) are used as reference. One of the models (PROGRASS; Lazzarotto et al., 2009) was originally developed to simulate the seasonal and inter-annual dynamics of grass/clover mixtures. The other model (MODVEGE, Jouven et al., 2006) was developed to predict herbage quantity and quality in productive systems on the basis of a grassland functional group classification.

Results and Discussion

Results indicate that both models can reproduce the seasonality of growth across sites. But while the effects of water stress on growth are correctly predicted in some years (e.g. 2003), they are overestimated in others (e.g. 2006) (Fig. 1). Compared to the baseline runs, tests with alternative formulations of the response of net assimilation to water stress show no significant improvement in model performance. This suggests an inadequate representation of processes contributing to drought avoidance (changes in the allocation of assimilates, enhanced root dynamics, compensating effects from

species interactions in mixtures, altered nutrient cycling, including symbiotic nitrogen fixation, etc.).

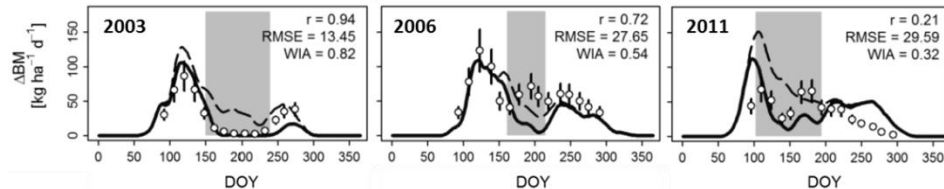

Figure 1. Observations (points and error bars) and simulations (lines) of daily herbage growth (ΔBM) at Changins (western Switzerland, $6^{\circ}13' \text{ E}$, $46^{\circ}24' \text{ N}$, 400 m a.s.l.) in (left to right) 2003, 2006 and 2011. Shown are simulations with (continuous lines) and without water stress (dashed lines). The period with significant water stress is highlighted in grey. Performance metrics (r : correlation coefficient; RMSE: root mean square error; WIA: index of agreement) are included in the upper right corner.

Contrasting the simulation of summer drought effects, we find the effects of spring drought to be underestimated by the models (Fig. 1). In this case, the problem is partially related to an inaccurate prediction of the start of the growing season.

Conclusions

In spite of recent advances, there is still room for improving the performance of grassland models regarding the simulation of the impacts of drought on grassland ecosystem functioning. As grasslands usually involve multiple species, ways to better account for community dynamics under water stress have to be examined. A firmer hold on root dynamics is also required, even though experimental results are still open to diverging interpretations (Prechsl et al., 2015). Finally, there is necessity for a more realistic description of grassland phenology. This is a difficult question that, to our knowledge, has yet to receive the necessary attention by the modelling community.

Acknowledgements

Research discussed in this report contributes to the project “Modelling vegetation response to EXTREME Events” (MODEXTREME, <http://modextreme.org>), which has received funding from the European Community's Seventh Framework Programme – FP7 (KBBE.2013.1.4-09) under Grant Agreement No. 613817, 2013-2016.

References

- Ammann, C., C. Spirig, J. Leifeld et al., (2009). *Agriculture Ecosystems and Environment*, 133: 150–162
- Deléglise, C., M. Meisser, E. Mosimann et al., (2015). *Agriculture Ecosystems and Environment*, 213: 94–104
- Jouven, M., P. Carrère and R. Baumont, (2006). *Grass Forage Science*, 61: 112–124.
- Knapp, A.K., J.M. Briggs, and J.K. Koelliker (2001). *Ecosystems*, 4: 19–28.
- Lazzarotto, P., P. Calanca and J. Fuhrer (2009). *Ecological Modelling*, 220: 703–724
- Meisser, M., C. Deléglise, L. Stévenin et al., (2015). *Recherche Agronomique Suisse*, 6: 400–407.
- Mosimann, E., M. Meisser, C. Deléglise et al., (2012). *Recherche Agronomique Suisse*, 3: 516–523.
- Prechsl, U.E., Burri S., Gilgen A.K. et al., (2015). *Oecologia*, 177: 97–111
- Whitehead, D.C. (1995) *Grassland nitrogen*. CAB International, Wallingford, 397 pp.

Enhancing crowsyst for intercropping modeling

B. Carlson¹ – R. Sommer² – B. Paul² – C. Stöckle¹

¹ Department of Biological Systems Engineering, Washington State University, Pullman, WA, USA

² International Center for Tropical Agriculture, P.O. Box 823-00621, Nairobi, Kenya

Introduction

Agricultural models have contributed greatly to enhancing knowledge of farming systems, but much of this knowledge has been focused on industrial countries where conventional farming practices dominate. As the need to focus on food security in developing countries become more apparent, process-based agricultural models need to adapt to better simulate a variety of different farming systems. An example of such systems is a method of intercropping commonly used by subsistence farmers in East Africa. To more accurately model such complex systems, we enhanced the CropSyst model (Stöckle et al., 2003) to simulate the simultaneous growth of two crops and their competition for light, water, and nutrients.

Materials and Methods

The intercropping model was implemented in CropSyst by partitioning radiation interception, water uptake, and nutrient uptake to two growing crops. Radiation interception by two plant species was modeled by defining two canopy layers based on the heights of the crops and as a function of their leaf area indexes; similar to methods outlined by Tsubo and Walker (2002). Water and nitrogen uptake was handled by allocating available resources based on a competitive factor; a function of current root morphology, demand, potential uptake, and crop specific parameters.

Model verification will be conducted using data collected during a maize (*Zea mays*)-bean (*Phaseolus vulgaris*) trial in the Tana River Basin in Kenya. Data analysis is still ongoing at time of abstract submission.

Results and Discussion

Results based on the maize-bean trial will be presented at the conference. However, initial results from the model using measured data from Washington State look promising. Solar radiation interception is partitioned between two crops grown simultaneously and their biomasses are affected as expected (Figure 1). Water uptake is correctly influenced by root morphology (Figure 2, middle column) and root physiology (Figure 2, right column).

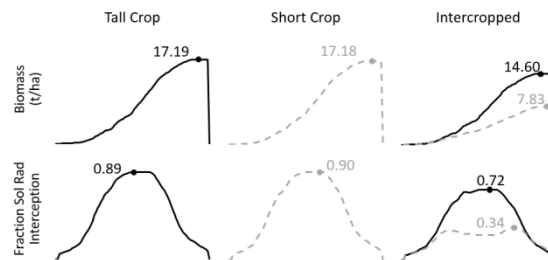

Figure 1. Simulated growth of two crops that are identical other than their maximum heights (1 m and 0.5 m respectively). Solid and dashed lines indicate tall and short crops, respectively. Numbers and their corresponding dot indicate the largest value for the corresponding measurement.

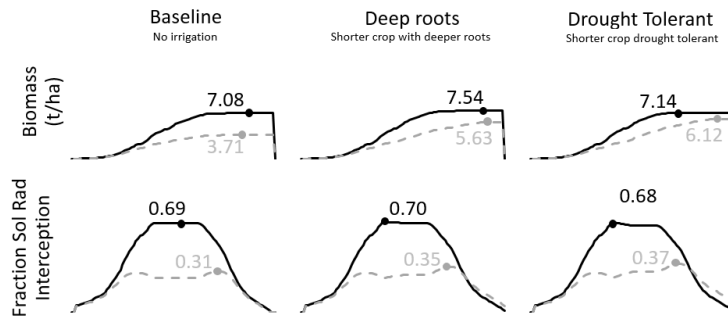

Figure 2. Simulated growth of two crops that are identical other than maximum height (1 m and 0.5 m) and/or root morphology and physiology. Solid and dashed lines indicate tall and short crops, respectively. Numbers and their corresponding dot indicate the largest value for the corresponding measurement.

Conclusions

The capability of modeling intercropping competition has been successfully incorporated into the CropSyst model and simulation results have been compared with preliminary data.

Acknowledgements

We acknowledge the financial support from a USAID Linkage grant under CGIAR Research Program on Livestock and Fish.

References

- Stöckle, C., Donatelli, M., Nelson, R. (2003). European journal of agronomy, 18(3): 289-307.
 Tsubo, M., and Walker, S. (2002). Agricultural and Forest Meteorology, 110(3): 203-215.

A generic coupled crop-disease model to analyze climate change effects on leaf rust of wheat

*J. Caubel*¹ – *M. Launay*² – *D. Ripoché*² – *D. Gouache*³ – *S. Buis*⁴ – *F. Huard*² – *L. Huber*⁵ – *F. Brun*⁶

¹ CNRS, UMR 8212 LSCE, US 1116 AgroClim, F- 91191 Gif-sur-Yvette

² INRA, US 1116 Agroclim, F-84914 Avignon

³ ARVALIS, ARVALIS – Institut du Végétal, F-91405 Orsay

⁴ INRA, UMR 1114 EMMAH, F-84914 Avignon

⁵ INRA, UMR 0211 Agronomie, F-78850 Thiverval-Grignon

⁶ ACTA, 149 rue de Bercy, F-75595 Paris

* Marie.Launay@paca.inra.fr

Introduction

Leaf rust (*Puccinia triticina*) of wheat can occur wherever wheat is grown and is broadly adapted to diverse climatic conditions, leading to regular and significant yield losses over large geographical areas. As climate change is expected to influence both the occurrence and development of crop diseases, Juroszek and von Tiedemann (2013) highlight the inconsistencies between studies concerning leaf rust under climate change. Understanding and anticipating the effects of climate change on leaf rust, requires consideration of both direct climate effects and indirect effects via host plants since host plants provide a microclimate and physical and trophic support for disease development. Modeling approaches coupling pathogen and crop models, make possible to simulate the complex interactions between the two biological systems, and dynamically reproduce their developments and, therefore, their synchrony. Moreover, examining the level of epidemiological processes allows the identification of the relevant triggers to solve agronomic issues. The goal of this presentation is to address the use of the STICS-MILA coupled crop-pathogen dynamic model (Caubel et al., 2012) to better analyze the projected impacts of climate change on leaf wheat rust in France.

STICS-MILA functioning and in silico experiment

The process-based MILA model simulates successive epidemiological cycles at the crop level and the daily time step. For each module corresponding to the epidemiological processes, several response functions are proposed that correspond to different situations of pathogen responses to climate, microclimate within the canopy, plant growth and development, and trophic status variables (Caubel et al., 2012). Appropriate options of simulation were selected for each module according to the literature to adapt the model for leaf rust of wheat (Fig. 1). Disease development is driven at a daily time scale by variables from the STICS crop model (Brisson et al., 2008), whereas the feedback from MILA to STICS consists in the daily reduction of the photosynthetic surface area.

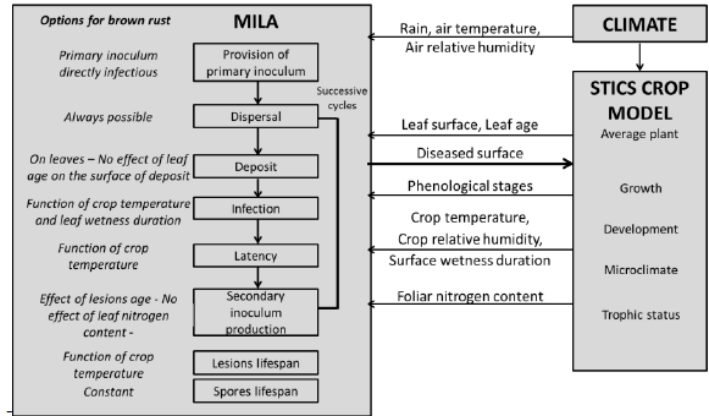

Figure 1. STICS-MILA coupled model

A theoretical analysis of future climate impacts was performed with STICS-MILA on three sites representative of different French climates and wheat production areas. Present and future climatic conditions (between 1950 and 2100) were simulated using a French global climate model, ARPEGE and the balanced A1B scenario.

Climate change impacts on leaf rust of durum wheat

Under a future climate, STICS-MILA predicted changes in disease earliness with an advance of the date at which 5 % of disease severity is reached of around one month in the far future (2070-2100). The microclimate in the canopy is expected to shorten latency periods and to increase infection efficiency, thus causing more infectious cycles, except in the western site where a decrease in precipitation counter-balances the positive effect of rising temperatures. The crop growth will accelerate during spring time, providing a greater physical and trophic support for disease development.

Conclusions

This coupled model is thus a useful tool for agronomists as well as pathologists to understand the climate change impacts on leaf rust of wheat. Moreover, scientists and stakeholders would benefit from its implementation to develop and test adaptation strategies to buffer future climate impacts on epidemics.

References

Brisson, N., M. Launay, B. Mary, N. Beaudoin (2008). Editions Quae, Versailles, 300 pp.
 Caubel, J., M. Launay, C. Lannou et al., (2012). Ecological Modelling, 242: 92-104.
 Juroszek, P. and A. von Tiedemann (2013). European Journal of Plant Pathology, 136(1): 21-33.

Integration of crop models into breeding programs

*S. Chapman*¹ – *B. Zheng*² – *M. F. Dreccer*² – *G. Hammer*³ – *D. Jordan*³ – *K. Chenu*³

¹ CSIRO Agriculture, Queensland Bioscience Precinct, 306 Carmody Rd, St Lucia, QLD 4067 Australia, e-mail: scott.chapman@csiro.au

² CSIRO Agriculture

³ Queensland Alliance for Agriculture and Food Innovation, The University of Queensland

Introduction

Instances of crop models playing a direct role in the improvement of plant breeding are relatively rare. A common conclusion in papers on modeling with parameters thought to genotypically vary is the declaration of a specific ‘ideotype’ that breeders ‘should aim to produce’ including in future climates (e.g. Chapman et al., 2012), with little insight into how the breeders should do this, or whether the physiological combination of ‘optimised traits’ is even achievable (too many papers can be cited here). A similar case of naïve optimism existed in physiology around 25 years ago when papers analyzing a small number of unrelated genotypes typically ended with a statement like ‘...and this trait should be useful to breeders’, (including a paper of the lead author (Chapman et al., 1993))! This paper considers some of the roles of models and choices of traits and targets where modeling can play a role in assisting breeders to drive selection across complex landscapes (Hammer et al., 2006).

Use of models in breeding

Despite justified skepticism of statements in the modeling literature, some breeders (Cooper et al., 2014) have the expectation that the quantitative application of gene to phenotype understanding within crop models will contribute substantially to the future of plant breeding. This optimism is well-founded based on a committed investment in and experience of a strong integration of genetics, physiology and modeling within commercial maize breeding, where crop models can both provide guidance (targeting of products) and influence how physiological understanding is leveraged into breeding outcomes. This degree of integration is beyond the capability of many public research efforts, although there are many initiatives to study ‘GxExM’ (Genotype by Environment by Management) in multiple crops around the world.

A breeding program runs a cycle of repeatedly improving germplasm to shuffle (with skill) gene combinations that result in improved adaptation (Fig. 1). In rainfed environments, environment characterization facilitates the targeting of testing resources, and understanding of opportunities for different types of adaptation. Gene-based prediction of flowering time in wheat assists breeders to target germplasm with ‘safe’ flowering windows to avoid frost and heat. While generation of GxExM landscapes in sorghum can nudge the ‘fanciful’ area of physiology, it can be instructive when the underlying model is physiologically ‘robust’, as well as provide testbeds for statistical methods in breeding (van Eeuwijk et al., 2010). Finally, a current need is in

integrating models with high-throughput phenomics systems to provide in-season prediction of model phenotypes, that can be 'subtracted' from observed data to remove impacts of 'known' traits and reveal the underlying residual genetics.

The challenge for modelers is to learn more about how plant breeding programs work, and to make greater efforts to collaborate directly with plant breeders to realize the benefits of these powerful tools.

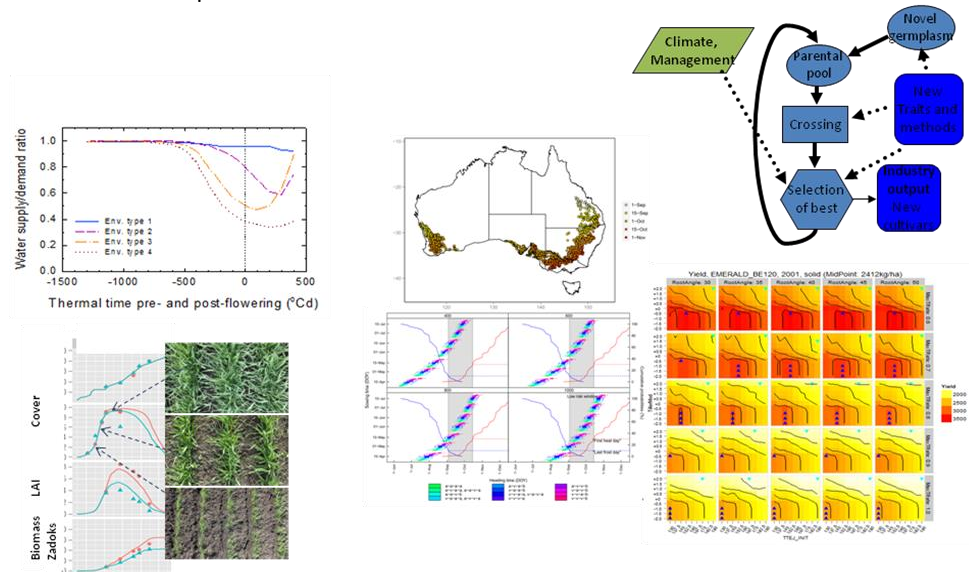

Figure 1. Roles of models in plant breeding programs (stylised in top right): Drought environment characterisation for wheat (top left, Chenu et al., 2014) (b) Phenotype prediction for flowering time (centre, Zheng et al., 2013); (c) GxExM landscapes to explore genetic trait value (bottom right, Chapman et al., 2003; Hammer et al., 2015); (d) Phenotype Assessment (bottom left, unpublished)

Acknowledgements

This research has been variously supported by the Grains Research and Development Corporation, the Generation Challenge Program and the Australian Government Department of Agriculture.

References

Chapman, S.C., M.M. Ludlow, F.P.C. Blamey, K.S. Fischer (1993). *Field Crops Res.* 32: 193-210.
 Chapman, S.C., S. Chakraborty, M.F. Dreccer, S.M. Howden (2012) *Crop & Pasture Science* 63, 251-268.
 Chapman, S.C., M. Cooper, D. Podlich, G.L. Hammer (2003). *Agron. J.* 95: 99-113.
 Chenu, K., R. Deihimfard, S.C. Chapman (2013) *New Phytol.* 198, 801-820.
 Hammer, G., M. Cooper, F. Tardieu et al., (2006) *Trends in Plant Sci.* 11, 587-593.
 Hammer, G.L., G. McLean, S.C. Chapman et al., (2014) *Crop & Pasture Sci.* 65: 614-626.
 van Eeuwijk F, M. Bink, K. Chenu, S.C. Chapman (2010) *Curr. Opin Plant Biol.* 13: 193-205.
 Zheng, B., B. Biddulph, D. Li et al., (2013) *J. Exp Bot.* 64, 3747-3761.

From a global sensitivity analysis of a crop model to wheat improvement in the field

*K. Chenu*¹ – *P. Casadebaig*^{1,2} – *J. Christopher*¹

¹ The University of Queensland, QAAFI, Toowoomba, QLD, Australia, karine.chenu@uq.edu.au

² INRA, UMR 1248 AGIR, 31326 Castanet-Tolosan, France

Introduction

Drought can dramatically limit crop production. In the quest for traits with greatest potential to improve productivity, we performed a global sensitivity analysis of the APSIM-Wheat crop model (Casadebaig et al., submitted) for environments representative of the Australian wheatbelt. APSIM-Wheat has been extensively used and tested across Australian environments (e.g. Chenu et al., 2011; Holzworth et al., 2014) where wheat crops regularly experience moderate to severe drought patterns (Chenu et al., 2013). By looking at the impact of all the traits from the model, we found promising results related to water extraction. We further studied traits related to (i) root architecture and (ii) the presumably-associated ability of crops to maintain a green canopy (due to better access to water supply) in controlled and field experiments.

Materials and Methods

A large set of traits was evaluated with APSIM-Wheat in a wide range of environments (4 sites x 125 years). A potential genetic range of +/- 20 % was considered for each trait compared to a reference cultivar (Hartog). The Morris sensitivity analysis method was used to sample the parameter space and reduce computational requirements (Casadebaig et al., submitted). While extractability of water by the roots was identified as the most influential trait, genotypic differences were observed for water extractability at depth (Manschadi et al., 2006). Simulations for this trait were performed for a larger set of locations (60 sites x 123 years) to assess its potential impact across regions (Veyradier et al., 2013).

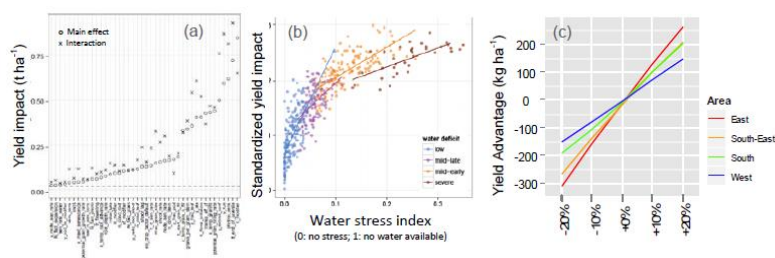

Figure 1. Yield impact of (a) the 42 APSIM-Wheat parameters identified as having a substantial impact, of (b) water extractability (greatest-impact parameter identified in a), and of (c) water extractability at depth (trait with genotypic variability observed in rhizotron) across the Wheatbelt. Yield impact in (a-b) correspond to the mean main sensitivity index from the sensitivity analysis (positive values). Adapted from Casadebaig et al., (submitted) and Veyradier et al. (2013).

Results and Discussion

For the Australian wheatbelt, 42 parameters were identified as having a substantial impact on wheat yield (Fig. 1a). The most influential trait related to water extraction by roots. The value of this trait was highly dependent of the environment, and increased with the severity of the drought experienced by the crop (Fig. 1b). Overall, water extraction at depth was predicted to have most value in the eastern part of the wheatbelt, where crops are cultivated on deep, heavy soils (Fig. 1c). Variations in deep root occupancy and water extraction were observed in deep rhizotrons (Fig. 2). The ability of crops to extract more water at depth allowed them to maintain a live canopy for longer period in the simulations and in field trials (Manschadi et al., 2006; Christopher et al., 2008; Veyradier et al., 2013). This staygreen phenotype was also associated to greater productivity under water limited environments (e.g. Christopher et al., 2008 and 2014). As deep root occupancy may be associated to the root angles of seedlings (Fig. 2; Manschadi et al., 2008), a high-throughput method was developed to screen numerous lines (Richard et al., 2015). Lines of a Nested Association Mapping population are currently being phenotyped for root traits and staygreen (Christopher et al., 2014) to unravel the genetic controls associated with these promising traits.

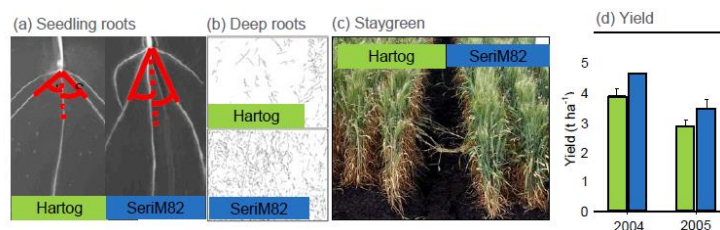

Figure 2. Seedling root angles (a), occupancy of roots at depth (90-112 cm) (b), staygreen phenotype (c) and yield (d) of wheat cultivars Hartog (reference) and SeriM82 (drought tolerant).

Acknowledgements

Thanks to B. Zheng and M. Veyradier for their help with the simulations, and S. Chapman for his constructive feedbacks.

References

- Casadebaig, P., Zheng, B., Chapman, S., et al., Submitted to Plos One.
- Chenu, K., Cooper, M., Hammer, G.L., et al., (2011). *Journal of Experimental Botany*, 62:1743-1755.
- Chenu, K., Dehmfard, R., Chapman, S.C., (2013). *New Phytologist*, 198:801-820.
- Christopher, J.T., Manschadi, A.M., Hammer, G.L., et al., (2008). *Australian Journal of Agricultural Research*, 59:354-364.
- Christopher, J.T., Veyradier, M., Borrell, A.K., et al., (2014). *Functional Plant Biology* 41:1035-1048.
- Holworth, D.P., Huth, N.I., deVoil, P.G., et al., (2014). *Environmental Modelling & Software* 62:327-350.
- Manschadi, A.M., Christopher, J., Devoil, P., et al., (2006). *Functional Plant Biology* 33:823-837.
- Manschadi, A.M., Hammer, G.L., Christopher, J.T., et al., (2008). *Plant and Soil* 303:115-129.
- Richard, C., Hickey, L., Fletcher, S., et al., (2015). *Plant Methods* 11:13.
- Veyradier, M., Christopher, J., Chenu, K. (2013). In: Sievänen, R., et al., 7th Conf. on FSPM, Saariselkä, Finland, 317-319.

The SoilC&N model: simulating short- and long-term soil nitrogen supply to crops

M. Corbeels^{1,2}

¹ Agro-ecology and Sustainable Intensification of Annual Crops, CIRQD, Avenue Agropolis, 34398 Montpellier, Cedex 5, France

² Sustainable Intensification Program, CIMMYT, United Nations Avenue, Nairobi, Kenya

Introduction

Carbon (C) and nitrogen (N) dynamics in the soil can be simulated by a number of approaches. Simple two-compartment models comprising a labile and stable organic matter pool can be analytically solved and parameter estimation for a given situation is relatively simple (e.g. ICBM, Kätterer and Andrén, 2001). However, these types of models do not incorporate important feedbacks of soil C and N to changing environment. More comprehensive models, such as CENTURY (Parton et al., 1987), have been developed for this purpose. Yet, most of these models do not consider explicitly microbial physiology as the driving factor of N immobilization-mineralization turnover, while this is fundamental for an adequate description of decomposition of soil organic matter (SOM) and soil N supply to crops.

Materials and Methods

The SoilC&N model includes above- and below-ground plant residue pools and three SOM pools (microbial biomass, Young and Old SOM) with different turnover times (Fig. 1). The distinctive features of this model are: 1) growth of microbial biomass is the process that drives N immobilization-mineralization, and microbial succession is simulated; 2) decomposition of plant residues may be N-limited, depending on soil inorganic N availability relative to N requirements for microbial growth; 3) N:C ratio of microbial biomass active in decomposing plant residues is a function of residue quality and soil inorganic N availability; 4) 'quality' of plant residues is expressed in terms of measurable biochemical fractions; and 5) C:N ratios of SOM pools are not prescribed but are instead simulated model output variables. Nitrogen is mineralized to, or immobilized from, the soil inorganic N pool to maintain the C:N ratio of decomposing microbial biomass within a specified range. Balancing potential microbial N demand against inorganic N availability determines whether the activity of decomposers is limited by N. If so, then simulated microbial use efficiency and decomposition fluxes are reduced.

Results and Discussion

SoilC&N can be used as a stand-alone model or coupled to a crop growth model to simulate within-season soil N supply from SOM and added organic sources to crops.

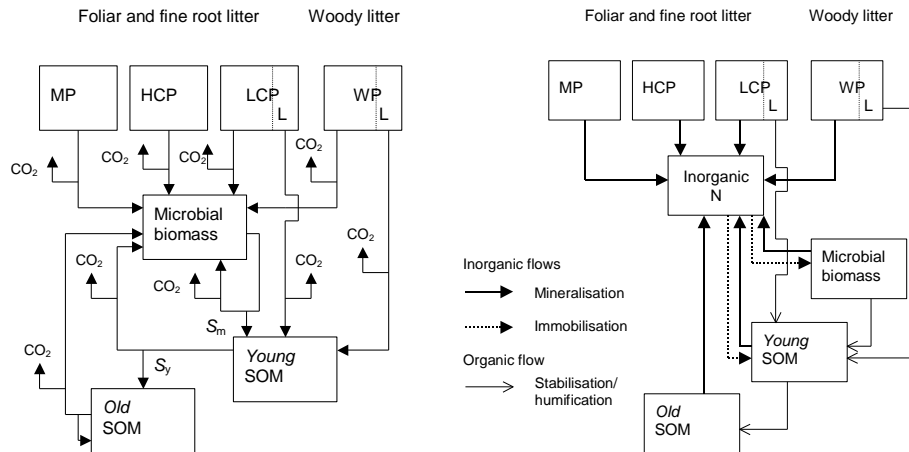

Figure 1. Pools and fluxes of (a) C and (b) N in the SoilC&N model. MP: metabolic pool; HCP: holocellulosic pool; LCP: ligno-cellulosic pool; L: lignin; SOM: soil organic matter; S_m : stabilisation coefficient for microbial biomass; S_y : stabilisation coefficient for Young SOM (from Corbeels et al., 2005).

The model responds to quality of added organic matter and predicts N immobilization or mineralization rates in time. The N immobilization peak depends on the biochemical quality of the plant residues and the available inorganic N. When soil inorganic N becomes severely limiting, decomposition of residues is slowed down. With a proper parameterization of plant residue ‘quality’, the model can acceptably predict N dynamics from crop residues ranging from green leguminous leaves to woody residues. Coupled to a crop growth model, SoilC&N is particularly suited for simulating the impacts of management or land-use changes on soil C storage and long-term N availability for plants. For example, the model is able to predict long-term storage of soil C following a change in land-use from forest to cropland, as a result of simulated changes in microbial activity, soil N availability and SOM C:N ratios to changes in plant residue quantity and quality. The incorporation of the feedbacks in the model between plant residue quality, N availability and microbial activity increases the mechanistic integrity of the model, compared to other models such as CENTURY or RothC (Coleman et al., 1997).

Conclusions

The ability of SoilC&N to adequately describe both short-term events such as soil N supply during one growing season, and long-term dynamics, e.g. soil C storage over several decades, is an important asset when coupling to a crop growth model.

References

- Coleman, K., D. Jenkinson, G. Crocker et al., (1997). *Geoderma*, 81: 29-44.
- Corbeels, M., R.E. McMurtrie, D.A. Pepper et al., (2005). *Ecol. Model.*, 187: 426-448.
- Kätterer, T. and O. Andrén (2001). *Ecol. Model.*, 136: 191-207.
- Parton, W.J., D.S. Schimel, C.V. Cole et al., (1987) *Soil. Sci. Soc. Am. J.*, 51: 1173-1179.

Modelling the genetic variability and genotype by environment interactions for leaf growth and senescence in wheat

A. Dambreville^{1,2} – *A. Maiorano*^{1,2} – *P. Martre*^{1,2}

¹ INRA, UMR759 Laboratoire d'Ecophysiologie des Plantes sous Stress Environnementaux, F-34 060 Montpellier, France, e-mail: pierre.martre@supagro.inra.fr

² Montpellier SupAgro, UMR759 2 Laboratoire d'Ecophysiologie des Plantes sous Stress Environnementaux, F-34 060 Montpellier, France

Introduction

The ability to predict leaf area index dynamics is crucial to predict crop growth and yield, particularly under conditions of limited resource supply (Ewert, 2004). Leaf area dynamic depends on several factors such as meteorological conditions, crop management or genetics. Most wheat crop models simulate leaf area index using a “big-leaf” approach where the whole canopy is treated as one big-leaf and several models simulate leaf area index indirectly from biomass production (Parent and Tardieu, 2014). However, because the response of leaf expansion and senescence to environmental factors strongly depends on leaf age and position (plastochron index), modelling the expansion and senescence of individual leaf is critical to predict the effect of combined stresses. Modelling the ontogeny and expansion of individual leaves also allows modelling the dynamic of tillers. Functional–structural models describe leaf area and tiller dynamics (e.g. Evers et al., 2005) but they are mainly descriptive and are difficult to parametrize for new genotypes. Here, we describe a new model of leaf area dynamics implemented in *SiriusQuality2* wheat model. This model links phenological development with leaf expansion and simulates the coordination between leaf sheath and lamina expansion and between phytomers and tillers. The model was evaluated using detailed field experiments with contrasted water and N supply. Finally, we demonstrated that the model is able to simulate the genetic variability and genotype by environment (GxE) interactions for leaf growth and senescence, and we discussed the use of phenotyping platforms to measure the genotypic parameters of the model on large genetic panels for genetic analysis.

Materials and Methods

SiriusQuality2 is a process-based wheat model composed of seven components modelling the development of the plant and the fluxes of water, N and carbon in the soil-plant-atmosphere continuum (<http://www1.clermont.inra.fr/siriusquality/>). Leaf expansion is modeled using 14 parameters related to internode, sheath and lamina growth. Daily leaf expansion and senescence is simulated in response to water and N deficit using a supply-demand approach. The most influential parameters were identified thanks to a global sensitivity analysis of the model (Martre et al., 2015) and the genetic variability of three influential parameters of the leaf area dynamics model was determined for a panel of 16 winter wheat modern cultivars grown in the field in France and UK with a range of water and N supply. Three additional parameters

related to the response of leaf expansion and senescence to water and N deficit were calibrated numerically for the same genetic panel.

Results and Discussion

The number (NLL) and potential size (AreaPL) of the leaves produced after floral initiation, and the potential ratio of the flag leaf to penultimate leaf size (RatioFLPL) strongly influenced leaf area dynamics. These three parameters were measured for 16 modern cultivars in field experiments with unlimited water and N supply. The range for these parameters were 3.9-5.6 leaves, 20.1-36.7 cm² and 0.67-1.27, respectively. Across the cultivars, the RatioFLPL was negatively correlated to the AreaPL meaning that a larger potential leaf size was related to a smaller flag leaf compared to the penultimate leaf. Variance analyses showed that the variability of these parameters were mainly due to genotypic effects. Three parameters related to the critical N mass per unit of leaf surface area of growing leaves and to the response of leaf expansion and senescence to water deficit were calibrated for the same genetic panel under conditions of limited resource supply. Across all environments and genotypes, the root mean squared relative error for LAI averaged 25 %. The model was able to capture around 60 % and 98 % of the genotypic (ranging from 2.5 to 3.6 m² m⁻²) and environmental (1.3 to 4.9 m² m⁻²) variability of LAI at anthesis.

Conclusions

We conclude that the leaf area model presented here is able to explain a large part of the genotypic and environmental effects on wheat leaf area dynamics using a minimum set of genotype-specific parameters. The three parameters related to the developmental pattern of potential laminae surface area are mainly under genetic control and can be easily determined in the field or in control conditions on large genetic panels. The three parameters related to the response of leaf expansion and senescence to N and water supply were calibrated numerically. This calibration requires large datasets with a range of water and N supply. However, these parameters could also be determined under control conditions in plant phenotyping platforms.

Acknowledgements

This work was supported by the European Union's Seventh Framework Programme (FP7/2007–2013; grant no. FP7-613556). AM has received the support of the EU in the framework of the Marie-Curie FP7 COFUND People Programme, through the award of an AgreeSkills fellowship under grant agreement n° PCOFUND-GA-2010-267196.

References

- Evers, J.B., J. Vos, C. Fournier et al., (2005). *New Phytologist*, 166: 801–812.
- Ewert, F. (2004). *Annals of Botany*, 93: 619–627.
- Martre, P., J. He, J. Le Gouis, M.A. Semenov (2015). *Journal of Experimental Botany*, 66: 3581–3598.
- Parent, B., and F. Tardieu (2014). *Journal of Experimental Botany*, 65: 6179–6189.

Do maize crop models catch the impact of future [CO₂] on maize yield and water use ?

*K. Delusca*¹ – *J. L. Durand*¹ – *K. Boote*² – *J. I. Lizaso*³ – *R. Manderscheid*⁴ – *H. J. Weigel*⁴ – *A. Ruane*⁵ – *C. Rosenzweig*⁵ – *J. Jones*² – *L. Ahuja*⁶ – *S. Anapalli*⁷ – *B. Basso*⁸ – *C. Baron*⁹ – *P. Bertuzzi*¹⁰ – *C. Biernath*¹¹ – *D. Derynge*¹² – *F. Ewert*¹³ – *T. Gaiser*¹³ – *S. Gayler*¹⁴ – *F. Heinlein*¹¹ – *K. C. Kersebaum*¹⁵ – *S. H. Kim*¹⁶ – *C. Müller*¹⁷ – *C. Nendel*¹⁵ – *E. Priesack*¹¹ – *J. Ramirez*¹⁸ – *D. Ripoche*¹⁰ – *R. Rötter*¹⁹ – *S. Seidel*²⁰ – *A. Srivastava*¹³ – *F. Tao*²¹ – *D. Timlin*²² – *T. Twine*²³ – *K. Waha*¹⁷ – *E. Wang*²⁴ – *H. Webber*¹³ – *Z. Zhao*²⁵.

¹ INRA, Lusignan, France; jean-louis.durand@lusignan.inra.fr

² University of Florida, Gainesville, United States of America

³ Technical University of Madrid, UPM, Madrid, Spain

⁴ Johann Heindrich von Thunen Institute, Braunschweig, Germany

⁵ NASA Goddard Institute for Space Studies, New York city, USA

⁶ ASRU, USDA-ARS, Fort Collins, Colorado, USA.

⁷ CPSRU, USDA-ARS, Stoneville, Mississippi, USA.

⁸ Department of Geological Sciences, Michigan State University, Michigan, USA

⁹ CIRAD, UMR TETIS, Montpellier, France

¹⁰ INRA, Avignon, France

¹¹ Institute of Biochemical Plant Pathology, Helmholtz Zentrum, München, Neuherberg, Germany

¹² Tyndall Centre for Climate Change research and School of Environmental Sciences, University of East Anglia, Norwich, UK

¹³ Institute of Crop Science and Resource Conservation, University of Bonn, Bonn, Germany

¹⁴ Institute of Soil Science and Land Evaluation, University of Hohenheim, D-70599 Stuttgart, Germany.

¹⁵ Institute of Landscape Systems Analysis, ZALF, Leibniz-Centre for Agricultural Landscape Research, Muencheberg, Germany

¹⁶ School of Environmental and Forest Sciences, University of Washington, Seattle, USA

¹⁷ Potsdam Institute for Climate Impact Research, Potsdam, Germany

¹⁸ School of Earth and Environment, University of Leeds, Leeds, UK CGIAR Research Program on Climate Change, Agriculture and Food Security (CCAFS), Cali, Colombia International Center for Tropical Agriculture (CIAT), Cali, Colombia

¹⁹ Natural Resources Institute, Luke, Finland

²⁰ Technische Universität Dresden, Germany

²¹ Institute of Geographical Sciences and Natural Resources Research, Chinese Academy of Sciences, Beijing, China

²² Crop Systems and Global Change Laboratory, USDA/ARS, Beltsville, USA

²³ Department of Soil, Water, & Climate, University of Minnesota, Minnesota, USA

²⁴ CSIRO, Land and Water, Black Mountain, Australia

²⁵ China Agricultural University, Beijing, China

Introduction

Maize is a major crop in the world. The ability of crop models to predict the complexity of the interactions behind the yield response to climate and especially to air CO₂ concentration [CO₂] needs to be tested (Bassu et al., 2012). Furthermore, the water use is a key issue for assessing our ability to sustain maize yields under future climate, since hotter and dryer conditions may become more frequent. In the study reported here, a Free Air CO₂ Enrichment (FACE) showing a very large impact of [CO₂] on yield

under drought (Manderscheid et al., 2014) was used to test the ability of 20 maize models to simulate the observed responses of yield and water use.

Materials and Methods

The Experiment combined two [CO₂] air concentrations: ambient and 550 ppm, approximately, crossed with two irrigation regimes bringing about contrasted soil water contents. Yield, water use, leaf area index, soil water content and [CO₂] levels were recorded in 2007 and 2008. However, only 2008 exhibited a significant water deficit. On that year a 40 % increase of yield, approximately, was observed under 550 ppm [CO₂], the crop water use remaining unaltered.

20 modelling groups using different crop models were given the same instructions and input data. Following a preliminary calibration (cultivar parameters) based on non-limiting water conditions and under ambient [CO₂] treatments of both years, a simulation was undertaken for the other treatments: High [CO₂] (550 ppm) 2007 and 2008, both irrigation regimes, and DRY AMBIENT 2007 and 2008.

Results and Discussion

As in the experiment, simulations showed virtually no yield responses to [CO₂] under non-limiting water conditions. Only under severe water deficits did models simulate an increase in yield for CO₂ enrichment, which was related to a higher harvest index and, for those models which simulated it, a higher grain number. However, the CO₂ enhancement under water deficit simulated by the 20 models was 20 % at most and 10 % on average only. As in the experiment, the simulated impact of [CO₂] on water use was negligible, with a general displacement of the water deficit toward later phases of the crop along with a longer green leaf area duration.

The very large impact of CO₂ reported in that experiment was mainly due to the coincidence of a strong water stress with anthesis, a short and sensitive phase of the growth cycle bringing about a large decrease in grain number. This was not detected properly by models which simulated a maximum water stress in later phase of the growing cycle. Both the ability of current models to catch the water use induced positive impact of CO₂ on yield and their difficulty to match the actual increase will be discussed.

References

- Bassu, S., Brisson, N., Durand, J.L. et al., (2014). How do various maize crop models vary in their responses to climate change factors? *Global change biology*, 20: 2301-2320.
- Manderscheid, R., Erbs, M., & Weigel, H. J. (2014). Interactive effects of free-air CO₂ enrichment and drought stress on maize growth. *European Journal of Agronomy*, 52: 11-21.

Effects of climate change and adaptation on crops and livestock in mixed farming systems in southern Africa

*K. Descheemaeker*¹ – *P. Masikati*² – *S. Homann-Kee Tui*³ – *O. Crespo*⁴

¹ Plant Production Systems, Wageningen University, PO Box 430, 6700 AK Wageningen, The Netherlands; katrien.descheemaeker@wur.nl

² World Agroforestry Centre (ICRAF) Lusaka, Zambia

³ International Crops Research Institute for the Semi-Arid Tropics (ICRISAT), Bulawayo, Zimbabwe

⁴ Climate System Analysis Group, University of Cape Town, South Africa

Introduction

African crop-livestock systems are vulnerable to climate change and need to adapt to sustain people's livelihoods. Proper adaptation planning depends on quantitative information on the crop, grazing and animal components of the systems and needs to take into account the large farm diversity in rural communities. In this study we linked the crop model APSIM (Holzworth et al., 2014) with the livestock model LIVSIM (Rufino et al., 2009) to take into account key component interactions and assess the effects of climate change and adaptation on different types of mixed farms.

Materials and Methods

The study was carried out in the Nkayi district of semi-arid Zimbabwe, where mixed farming systems with cattle and maize are predominant. Cattle graze rangelands during most of the year and are fed crop residues during the dry season. Differences in cattle ownership and cultivated land area determine the diversity in the farming community. We integrated locally calibrated crop and livestock models to simulate farms in the current and future (mid-century) climate, with a predicted 3.5°C temperature increase and 15 % reduction of growing season rainfall. We compared current management of low-input maize with an adaptation package, consisting of increased N fertilizer rate (from the current 3 kg N/ha to 17 kg N/ha) and rotation with the fodder legume *Mucuna* (30 % of biomass retained in-situ, 70 % fed to livestock). Stover yields and grass growth from APSIM were combined with crop area and livestock stocking density to assess monthly feed availability, which was used as an input in LIVSIM. Models were run for 30 years and 159 households.

Results and Discussion

Reduced grass growth (Figure 1a) due to climate change lowered feed intake from the rangelands by 10 to 50 %. Under the current low input practice, climate change reduced maize grain yield by only 2 %, but stover yield by 15 % (Figure 1b). Applying the low-risk micro-dosing rate of 17 kg N/ha largely off-set these reductions, and the effect of rotation with *Mucuna* was larger (Figure 1b). The effects on livestock followed the trends in grass and on-farm fodder availability. Annual milk production was reduced by climate change by 40 and 35 % for the poor (1-8 cattle) and better-off (> 8 cattle) households respectively, whereas adopting the adaptation package lifted

production back up to what is currently achieved (Figure 2a). A similar result was obtained for other livestock productivity indicators such as calving rate (Figure 2b).

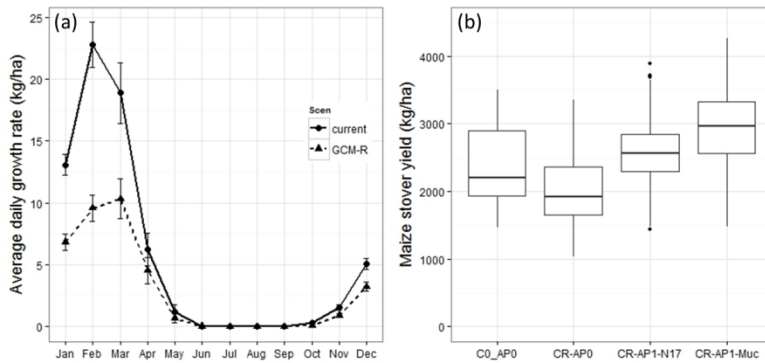

Figure 1. APSIM-simulated daily grass growth under current and future climate, with standard error (a); maize stover yield under current (C0) and future (CR) climate with current management (AP0) and adapted management with nitrogen fertilizer at 17 kg N/ha (N17) and rotation with Mucuna (Muc) (b)

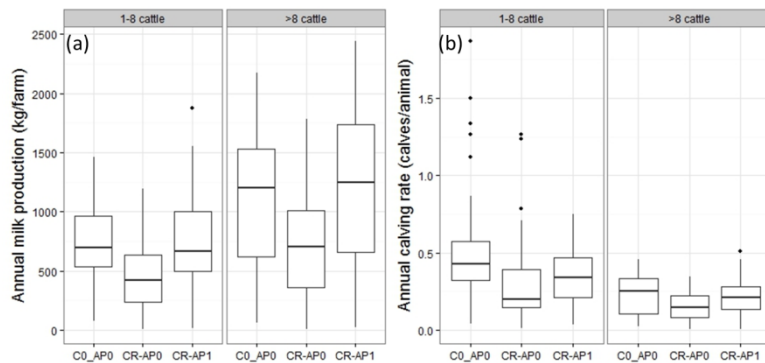

Figure 2. LIVSIM-simulated annual milk production (a) and calving rate (b) under current (C0) and future (CR) climate with current (AP0) and adapted management (AP1), consisting of maize fertilization and rotation with Mucuna for poor (1-8 cattle, n=61) and better-off (>8 cattle, n=31) farms

Conclusions

Linking a crop model with a livestock model allowed investigating the effects of climate change on the key components of diverse mixed systems. Including a fodder legume in the crop mix mitigated negative climate change effects both on maize and livestock.

Acknowledgements

We thank DFID for funding the AgMIP regional project.

References

- Holzworth, D.P., N.I. Huth, P.G. deVoil et al., (2014) *Environmental Modelling & Software*, 62: 327–350.
- Rufino, M.C., herrero, M., van Wijk, M.T., et al., (2009) *Animal*, 3: 1044-1056.

SAMARA: A crop model for simulating rice phenotypic plasticity

M. Dingkuhn – U. Kumar – M. R. Laza – R. Pasco

International Rice Research Institute, DAPO Box 7777, Manila, Philippines. e-mail: m.dingkuhn@irri.org

Introduction

Plant adaptation to variable resources depends on phenotypic plasticity, enabling adjustment of organ deployment and growth to balance source-sink relationships. Plasticity in rice is mostly compensatory and stabilizes harvest index (HI). Since Donald (1968) proposed the concept of ideotype, breeders sought modifying morphology to increase yield, e.g., in green revolution semidwarfs, IRRI's New Plant Type or China's Super Hybrid Rice (Dingkuhn et al., 2015). But effects of modified morphology and partitioning can be absorbed by compensatory plasticity resulting in unchanged yield. Crop models unable to simulate plasticity are not suited to predict ideotype performance. We sought to model compensatory plasticity with the new crop model SAMARA using IR72 rice. Plasticity in organ number and size is driven by an internal competition index (I_c) relating fresh assimilate supply (S) to aggregate demand (D) in growing organs [$I_c=S/D$]. Low S triggers reserve mobilization, reduced organ size and mortality of leaves or tillers. $I_c>1$ promotes storage. The objectives were to (1) study experimentally effects of population and environment on morphology and yield, (2) calibrate and validate SAMARA, and (3) evaluate observed and simulated plasticity.

Materials and Methods

A field trial was conducted in 4 environments in the Philippines: 2012 dry season (DS) and wet season (WS) at International Rice Research Institute (IRRI); 2012 and 2013 DS at the Philippine Rice Research Institute (PRRI). Design was split-plot RCB (4 replications) with factors stand density (D1, 25 hills m^{-2} ; D2, 100 hill m^{-2}) and genotype (12 cvs., with only IR72 reported). Fourteen or 21 d old seedlings were transplanted at 2 seedlings $hill^{-1}$ and kept flooded thereafter, using local practice for inputs. For growth analysis, samples were taken at panicle initiation (PI), flowering (FL) and physiological maturity (PM). SAMARA was calibrated using PRRI 2013 DS data (25 hill m^{-2}). Validation was done with 14 combinations of seasons, years, stand densities and sites. For model description with source code, parameters, and input/output variables read <http://umr-agap.cirad.fr/en/equipes-scientifiques/modele-samara>. Data was analyzed with STAR V2.0.1 (IRRI 2014).

Results and Discussion

Calibrated for IR72, SAMARA simulated tiller production and mortality, and organ dw dynamics (Fig.1A); and plant height, leaf number/size, filled/unfilled spikelets panicle⁻¹, and stem reserve dynamics (not shown). Validation for 14 environments gave accurate predictions for agdw at FL ($R^2=0.64^{***}$) and physiological maturity (PM) ($R^2=0.62^{***}$),

grain yield ($R^2=0.77^{***}$), culm number hill⁻¹ at PI ($R^2=0.94^{***}$) and PM ($R^2=0.84^{****}$), and green leaf dw at FL ($R^2=0.58^{***}$).

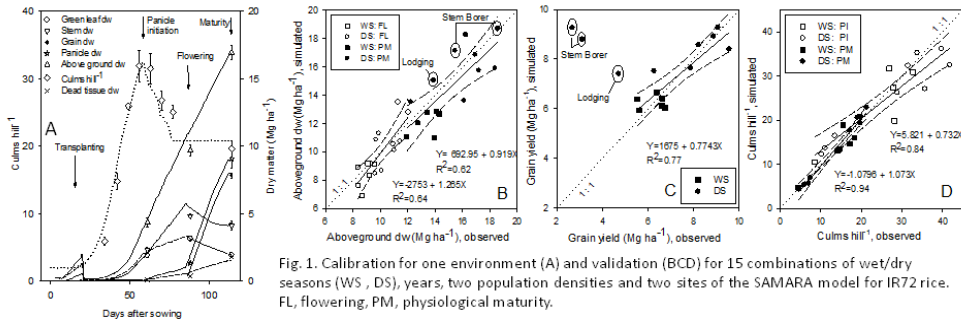

Fig. 1. Calibration for one environment (A) and validation (BCD) for 15 combinations of wet/dry rice seasons (WS, DS), years, two population densities and two sites of the SAMARA model for IR72 rice. FL, flowering, PM, physiological maturity.

Across the 4 trials, high population reduced tillers hill⁻¹, plant height, flag leaf size, HI and spikelets panicle⁻¹, while increasing LAI, agdw, and tillers and panicles per area (Fig. 2). The model predicted accurately these trends, and also picked up the slight reductions in spikelet fertility and grain yield.

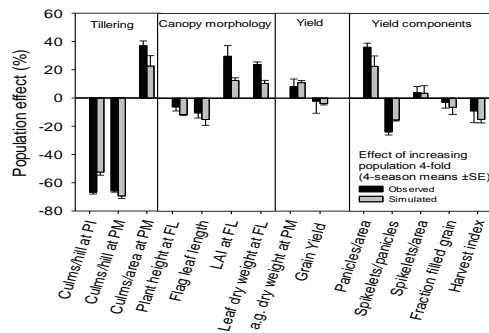

Figure 2. Mean effect (\pm SE) across 4 environments of 4-fold increased population on observed (black) and simulated (grey) crop variables.

Conclusions

SAMARA captures compensatory plasticity accurately. Next, we will study broader genetic diversity and evaluate yield gains from hypothetical ideotype concepts.

Acknowledgements

This study was supported by the CGIAR Research Programs CCAFS and GRiSP. SAMARA development was supported by Gesellschaft für Internationale Zusammenarbeit (GIZ, Germany).

References

Dingkuhn M, Laza MRC, Kumar U, Mendez KS, Collard B, Jagadish KSV, Kumar A, Singh RK, Padolina T, Malabayabas M, Torres E, Rebolledo MC, Manneh B, Sow A. (2015). Improving Yield Potential of Tropical Rice: Achieved Levels and Perspectives through Improved Ideotypes. *Field Crops Res.*
 Donald, C.M. (1968). The breeding of crop ideotypes. *Euphytica*, 17: 385-403.

Modelling agricultural management in multi-model simulation systems

*M. Donatelli*¹ – *S. Bregaglio*² – *G. Fila*¹

¹ Council for Agricultural Research and Economics, via di Corticella 133, 40128 Bologna, Italy, marcello.donatelli@entecra.it

² Department of Agricultural and Environmental Sciences, University of Milan, 20133 Milan, Italy

Introduction

An accurate description of agro-management (AM) operations in agricultural models ensures a realistic simulation of the underlying cropping system. This allows testing technical options in order to optimize resource-use efficiency (Merot and Bergez, 2010), to design innovative and sustainable crop management systems (Chatelin et al., 2007) and to cope with new constraints to production activities, such as those deriving from climate change (e.g. Aurbacher et al., 2013). Implementing the simulation of AM operations in a multi-model simulation system is a challenge for two reasons: (i) the operation timing is set based on the state of the system, not uniformly represented in different models, and (ii) their impact models can be implemented using different approaches, hence requiring different sets of parameters. The modelling approach of the AgroManagement model library was conceived to overcome these limitations and to provide a generic and flexible AM simulator to be used within agricultural system models. AgroManagement uses the software architecture of BioMA (<https://en.wikipedia.org/wiki/BioMA>), which favors reusability across modelling frameworks.

Modeling and design concepts

An AM simulator must be capable to reproduce the timing of farmers' actions, and to implement their impacts on the agro-ecosystem accordingly. In AgroManagement this objective is realized via the "rule-impact" approach. *Rules* are sets of conditions which needs to be fulfilled to trigger a specific action. *Impacts* are sets of parameters allowing the simulation of the AM action, hence conveying information to modify the states of biophysical system. A set of rule-impact couples defines a production technique. *Rules* and *Impacts* can be coupled freely, except for those rules which set a value for a specific parameter, hence requiring a specific *Impact* object to be coupled (e.g. under given conditions, refill soil water content to field capacity; the volume needed is passed as irrigation amount in the *Impact*).

Rules are dynamically tested against *States*, which are run-time state variables of the system. Whenever a rule is satisfied, the associated impact and the set of parameters relevant to the AM operation are published. AgroManagement is not aware of which model will use the information; the AM event is then listened by all models in a modelling solution, each potentially reacting via a specific impact model.

The separation between event publishing and response implementation is crucial to facilitate cross-system application, avoiding dependencies to specific modelling approaches.

Rules, *Impacts* and *States* are autonomously extensible by third parties and are realized as classes implementing programming interfaces respecting design-by-contract principles. They expose a semantically explicit interface and provide self-testing capabilities, such as pre- and post-conditions checking. Inputs and outputs of the components use XML formats. AgroManagement has no external dependencies other than the BioMA core component of the Model Layer, and can be reused across modelling frameworks. The AgroManagement Configuration Generator (ACG) is a key application provided to use the AgroManagement model library, allowing creating, editing, and graphically displaying .xml files containing AM configurations. Given that specific models respond to specific *Impacts* ACG can be configured to allow selections which are relevant to the specific modelling solution, and select parameters keys which correspond to data records available.

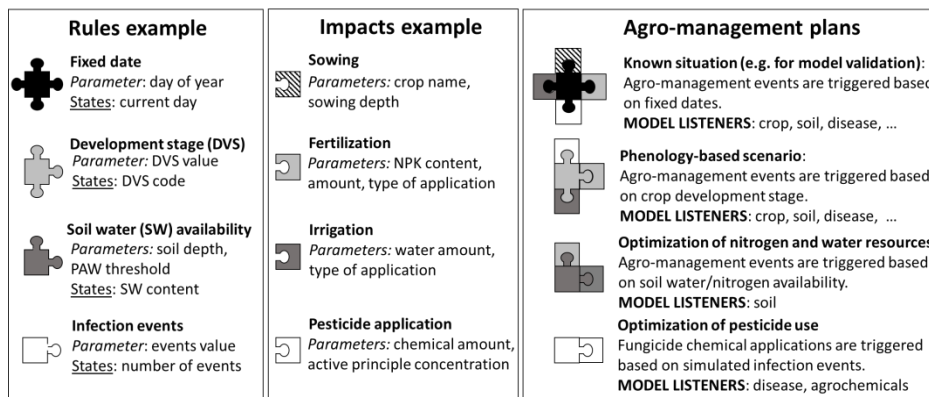

Figure 1. Example of rules and impacts are provided, together with parameters and required input state variables of the cropping system. Narrative agro-management plans are described as the result of rules and impacts coupling, with different models listening to the resulting AM operations.

Ancillary software applications

The Model Component Explorer (MCE) allows inspecting the interfaces and ontologies of BioMA-compliant components, supporting extensions and user customization. The Model Parameters Editor (MPE) dynamically builds a user interface and allows editing parameter files with keys which can be selected in AgroManagement configurations. The software is available at <http://components.biomamodelling.org>

References

- Aurbacher, J., P.S. Parker, G. A. Calberto Sánchez et al., (2013). *Agricultural Systems* 119, 44-57.
 Chatelin, M.H., C. Aubry, F. Garcia (2007). *Agronomy for Sustainable Development* 27, 337-345
 Merot, A., J.E. Bergez, (2010). *Environmental Modelling & Software* 25, 421-432.

Using Earth Observation and ancillary data sources as alternative to household surveys for regional integrated assessments

W. Durand¹ – D. Cammarano² – O. Crespo³ – W. A. Tesfuhney⁴

¹ Agricultural Research Council, Private Bag X1252, Potchefstroom, 2520, South Africa, DurandW@arc.agric.za

² The James Hutton Institute, Invergowrie Dundee DD2 5DA, Scotland, Davide.Cammarano@hutton.ac.uk

³ Environmental and Geographical Science Department, University of Cape Town, South Africa, olivier@csag.uct.ac.za

⁴ University of the Free State, PO Box 339, Bloemfontein, 9300, South Africa, weldit78@yahoo.com

Introduction

The approach the Agricultural Model Inter-comparison Improvement Program (AgMIP; <http://www.agmip.org>) has developed to assess the impacts of climate change on the agricultural systems at regional scale is based on household surveys to supply the necessary data inputs to crop and economic models (Rosenweig and Hillel, 2015). In South Africa, however, no such detailed survey data could be obtained and an alternative method had to be developed.

Materials and Methods

As alternative to household surveys, a maize crop field level land cover was developed using Earth Observations and linking this to regional enterprise budgets. Using Landsat and Spot images, 14 million hectare of field boundaries was digitized. The field crop boundaries were used as basis for an aerial-survey of fields identifying crops planted. The identified crop type per field was used for satellite image classification. For the maize crop field level land cover all fields that were identified to have been planted to maize were integrated into one data basis. To establish crop management input for crop modelling samples obtained from objective yield surveying were used to calculate the proportion of fields with certain row widths, planting dates and plant populations. The same proportion was used to assign the management strategies to all the fields within the Free State using GIS. Fertilization was based on the average modelled 50 year yield potential of each field. The soil properties required for crop yield modelling were derived using the identified soil series suitable for maize production from Terrain Units of land type maps within a GIS framework. This assigned each field a unique soil description. Pedo-transfer functions were used to calculate soil model inputs (Smithers and Schulze 1995). Two sources of climate data were used. The first set of climate change scenarios were developed by the University of Cape Town based on the quinary catchments database (Schulze, 2010, Schulze et al., 2010) covering the whole of South Africa. The second set was only for the Bethlehem district and followed the AgMIIP protocol. Economic data for the TOA-MD model was obtained from enterprise budgets published annually by GrainSA for different regions.

Results and Discussion

Using GIS all the climate, soil and management inputs required to run the crop model for each field could be collated and exported to Excel as input to the QUAD-UI tool. The QUAD-UI tool allowed for the rapped assembly of large amounts of crop model runs required for climate change studies. Field level simulations have the advantage that they can be summarized to different levels such as, farms, quinary catchments or districts. Results can easily be presented in table, graph, and map format. Crop model runs using DSSAT have been successfully tested to simulate 130 000 fields using different climate scenario's resulting in over 46.6 million simulations. To post process the data use was made of a geo-database in ArcGIS10.1. On a slightly smaller scale, 400 simulations in the Bethlehem district were tested to the level of integrating economic data. This was easily achieved, as for each field fixed and variable costs could be allocated straightforwardly. Together with other ancillary data this was adequate to run a TOA-MD economic analysis (Antle et al., 2010).

Conclusions

Linking satellite imagery derived and ancillary survey data to crop and economic models proves to be a good alternative method to replace household survey data to assess impacts of climate change on maize production at field to district level in South Africa.

Acknowledgements

This research was sponsored by USDA and UKAID. The authors would also like to acknowledge the coordination and leadership of AgMIP from Columbia University, the University of Florida and Oregon State and of NASA for the technical support.)

References

- Antle, J.M., Stoorvogel, J. J., and Valdivia, R. O. (2014). New parsimonious simulation methods and 21 tools to assess future food and environmental security of farm populations, *Philos. Trans. R. 22 Soc. Lond. B Biol. Sci.*, 369(1639), 20120280.
- Rosenzweig, C., and D. Hillel (2015): Major findings and future activities. In *Handbook of Climate Change and Agroecosystems: The Agricultural Model Intercomparison and Improvement Project (AgMIP)*, Part 2. C. Rosenzweig, and D. Hillel, Eds., ICP Series on Climate Change Impacts, Adaptation, and Mitigation Vol. 3. Imperial College Press, 411-426.
- Schulze, R.E., Hutson, J.L. and Cass, A. (1985). Hydrological characteristics and properties of soils in Southern Africa 2: Soil water retention models. *Water SA*, 11, 129-136.
- Schulze R. E. (2010). *Atlas of Climate Change and the South African Agriculture Sector: A 2010 perspective*. [Internet] Available from: <http://www.nda.agric.za/doiDev/sideMenu/others/CCDM/docs/AtlasOfClimateChangeSAagricSector.pdf>. [Accessed 1 December, 2013].
- Schulze, R. E., Hewitson, B. C., Barichievy, K. R., Tadross, M. A., Kunz, R. P., Lumsden, T. G. & Horan, M. J. C. (2010). *Methods to Assess Eco-Hydrological Responses to Climate Change over South Africa*. Water Research Commission, Pretoria, RSA, WRC Report 1562/1/10. pp 206.
- Smithers, J., and Schulze, R.E. (1995). *ACRU Hydrological Modeling System: User Manual version 3*. Water Research Commission, Pretoria. Alington, A., B. Bewater, C. Cecil et al., (2012). *Acta Agronomica Berlingia*, 55: 47–61.

Past and future weather-induced risk in crop production

J. Elliott

Computation Institute and Department of Geophysical Sciences, University of Chicago, Chicago, IL 60637, USA

Introduction

The global food system has seen increased volatility in recent years, with spiking food prices blamed for civil unrest on several continents. Rising prices for global commodity products like soy, meat and palm are increasingly driving deforestation around the globe, and with agriculture increasingly interconnected to global food and energy markets, weather-related risk and supply-side shocks have become a key issue or concern for governments and businesses alike.

Using archives from the Agricultural Model Intercomparison and Improvement Project (AgMIP) and the Intersectoral Impact Model Intercomparison (ISI-MIP), we look first at the impacts of 65 years of continental and global extreme events using observation-driven models and data. We identify the most severe historical events in caloric terms at national to global scales and evaluate the ability of models and model ensembles to identify weather-induced extreme years, correctly assess the magnitude of large-scale extreme events, reproduce historical country-level variability, and reproduce spatial patterns of losses under extreme drought.

We next consider global crop models driven with large ensembles of climate model output (both under historical forcing and with future scenarios) to characterize present day risk and the extent of non-stationary risk in global crop production. We find increasing, and in many cases accelerating risk, of extreme global loss events even in scenarios with little to no climate-induced long-term mean changes. In some cases, one-year global-scale production loss events that would have recently been called 1-in-100 year events are estimated to occur every 30 years by mid-century, and every 10-20 years by end-of-century. We discuss some regional and global protective measures that might be introduced, including increased trade, stock-hoarding, crop breeding, and improved forecasts, monitoring, and modeling.

The development of crop modeling methods to assess the combined threat of ozone and climate extremes on crops in south asia

*L. D. Emberson*¹ – *P. Bueker*¹ – *A. Briolat*¹ – *S. Osborne*^{1,2} – *J. Sillmann*³ – *G. Mills*²

¹ SEI York, Environment Department, University of York, Heslington, York, YO10 5DD, e-mail: l.emberson@york.ac.uk (corresponding author)

² Department, Institute, Faculty, University

³ Center for International Climate and Environmental Research – Oslo (CICERO), Oslo, Norway

Introduction

Extreme climate and ground level ozone (O₃) air pollution stress are likely to co-occur and affect agro-ecosystems. This is due to elevated O₃ episodes being more frequent under hot, dry sunny conditions as well as in rural agricultural regions (downwind of source O₃ precursor pollutant emissions). Most studies on future climate extremes use global climate model simulations, which are generally unable to resolve small-scale features that are necessary to accurately assess impacts on yield (IPCC 2014). In addition, most pollution risk assessment studies have used methods that relate damage to ambient ozone (O₃) concentrations rather than stomatal O₃ flux, now widely accepted as the most suitable predictor of damage. Even where stomatal O₃ flux is used, studies rely on whole season accumulations from which to determine yield losses even though O₃ will be compromising photosynthetic capacity over far shorter time-periods (days to weeks rather than growing seasons). A new international research project (CiXPAG) will use a combination of finer spatially and temporally resolved meteorological data (for both current and future projected climates) in conjunction with a new photosynthetic based O₃ deposition and stomatal flux model (DO₃SE) to produce novel methods to assess the effects of interactions between heat, drought and O₃ on photosynthesis, crop growth and yield. CiXPAG will focus on South Asia where high O₃ concentrations and climate extremes are already threatening crop productivity in a food insecure region.

Materials and Methods

The stomatal conductance (g_{sto}) component of the DO₃SE model uses a coupled photosynthesis-stomatal conductance module ($A_{net}-g_{sto}$) allowing a consistent estimate of the exchange of CO₂ (driven by supply and demand of CO₂ for photosynthesis and its products); water vapour and stomatal O₃ uptake (both controlled by g_{sto}). The $A_{net}-g_{sto}$ model consists of i. the mechanistic and biochemical Farquhar model (Farquhar et al., 1980) that estimates net photosynthesis (A_{net}) and ii. the empirical $A_{net}-g_{sto}$ model that estimates g_{sto} (Leuning, 1990). The $A_{net}-g_{sto}$ model has been developed to allow for O₃ damage to $V_{c,max}$ (the maximum carboxylation capacity of photosynthesis) based on methods similar to those initially developed by Martin et al., (2000) and Ewert et al., (1999). This model will be capable of dynamically integrating the effects of climate extremes and O₃ on crop growth and yield.

Results and Discussion

Initial results (Fig 1) show the capability of the $V_{c_{max}}-O_3$ damage model to simulate changes in $V_{c_{max}}$ under an elevated O_3 exposure regime over the course of a growing season for soybean, an important South Asian crop. This model uses fine scale meteorological and O_3 data which will be available from the regional downscaling modelling planned in the CiXPAG project.

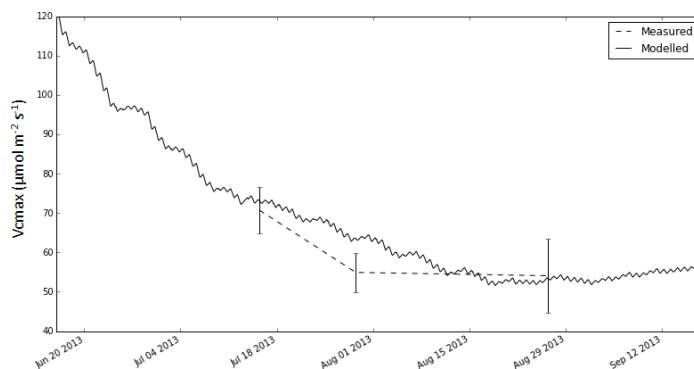

Figure 1. Modelled vs measured changes in $V_{c_{max}}$ over the course of a growing season for a south Asian crop (in this instance soybean) exposed to an elevated O_3 exposure.

Conclusions

These new risk assessments will inform policy through evaluating a number of emission storylines to identify those most likely to mitigate the effects of both O_3 pollution and climate change. The work will also develop new O_3 damage crop modelling methods that can be easily incorporated into existing photosynthesis-based crop modelling methods for application among the wider crop modelling community.

Acknowledgements

This work has been funded by the Norwegian Research Council supporting the CiXPAG project.

References

- Ewert, F., van Oijen, M. and Porter, J. R. (1999): Simulation of growth and development processes of spring wheat in response to CO_2 and ozone for different sites and years in Europe using mechanistic crop simulation models, *Eur. J. Agron.*, 10(3-4), 231–247, doi:10.1016/S1161-0301(99)00013-1
- Farquhar, G.D., von Caemmerer, S., Berry, J. A. (1980): A biochemical model of photosynthetic CO_2 assimilation in leaves of C_3 species, *Planta*, 149, 78–90
- Leuning, R. (1990): MODELING STOMATAL BEHAVIOR AND PHOTOSYNTHESIS OF EUCALYPTUS-GRANDIS, *Aust. J. Plant Physiol.*, 17(2), 159–175
- Martin, M J., Farage, P.K., Humphries, S.W., and Long, S. P. (2000): Australian Journal of Plant Physiology, *Aust. J. Plant Physiol.*, 27, 211–219

Shift in China's Agro-climatic Resource Inventory under Climate Change

*G. Fischer*¹ – *L. Sun*^{1,2,3,*} – *Z. Tian*^{4,*} – *Z. Liang*⁴ – *H. Yan*⁵

¹ International Institute for Applied Systems Analysis, Laxenburg, Austria.

² Department of Geographical Sciences, University of Maryland, USA

³ School of Oriental and African Studies, University of London, UK.

⁴ Shanghai Climate Center, Shanghai, China.

⁵ Institute of Geographical Sciences and Natural Resources Research (IGSNRR), Chinese Academy of Sciences, Beijing, China.

* Corresponding author, Laixiang Sun: lsun123@umd.edu; Zhan Tian: tianz@climate.sh.cn

Introduction

China's demand for grains has been growing rapidly and the growth is expected to continue in the coming decades, largely as a result of the increasing demand for meat. This leads to a great concern on future supply potentials of Chinese agriculture under climate change and the extent to which China would have to depend on world markets. In the large body of literature assessing future crop production based on spatially explicit crop models, the representative results indicate that without the benefit of CO₂ fertilization, the impact of which is still debated, climate-induced yield reductions are 4-14 % for rice, 2-20 % for wheat and 0-23 % for maize by the 2050s, suggesting quite adverse implications for China's food security. However, these assessments focus on single crops only and neglect the improved multi-cropping opportunities induced by climate change, thus tending to over-estimate the adverse impacts of climate change on crop production. Here we provide an additional dimension of climate change impacts by focusing on the shift in China's agro-climatic resource inventory. Based on an ensemble of 30 General Circulation Models (GCMs) under 4 Representative Concentration Pathway (RCP) scenarios in the CMIP5 (Phase 5 of Coupled Model Inter-comparison Project), we demonstrate that the significant northward extension of single-, double- and trip-cropping zones will provide good opportunities for crop rotation based adaptation.

Materials and Methods

Our assessment of China's agro-climatic resource inventory employs a probabilistic approach by making use of multi-model ensemble output on climatic elements which influence the suitability and productivity of crops. We use a cropland map with a spatial layer of paddy land, at a 1:100,000 scale from China's National Land-Use/Land Cover Dataset 2000 (Liu et al., 2005). We use soil information primarily derived from the Harmonized World Soil Database (HWSD), a comprehensive and state-of-the-art database developed by IIASA and FAO (FAO, 2012). Data on climatic requirements of crops, their growth cycles, development stages and yield formation periods were taken from the dataset of crops/land utilization types (LUTs) in Global Agro-ecological Zones

(GAEZ version 3.0) developed by FAO and IIASA. This dataset relates to 49 crops comprising of about 280 sub-types/LUTs.

Results and Discussion

We report one set of our main results in Fig. 1. It shows the extent of the northwards and/or northeast wards shifts of multi-cropping zones from their baseline north borders to the 2050s' north borders under 17 GCMs driven by the RCP4.5 scenarios. Ensemble of all result shows statistically significant northward shifts of multi-cropping zone extents. Such shifts create significant increases in multi-cropping opportunities.

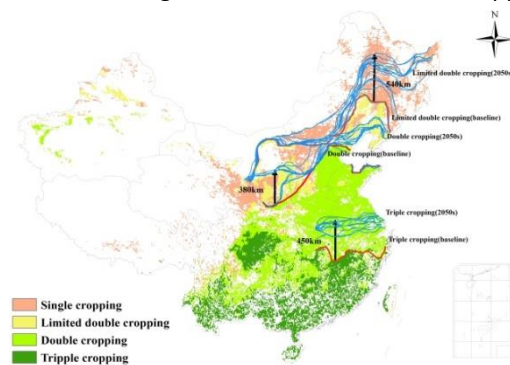

Figure 1. Shifts of multi-cropping class extents in irrigated cropland from the baseline to 2041-2070 under 17 GCMs driven by RCP4.5 emission scenario.

Conclusions

Our simulation experiments highlight that the systematic improvement of multi-cropping conditions in China's farmland is an important factor that dominates the overall changes in crop production potential that can be expected under future climate change. This significant increase in the production potential of China's agro-climatic resource base calls for technological and policy preparedness so that any newly emerging multi-cropping opportunities can be readily utilized in the decades to come. As more than 70 % of China's current food production comes from irrigated fields, securing future irrigation water supplies and improving irrigation water use efficiency will be essential for exploiting future enhanced temperature regimes especially in north and northeast China.

Acknowledgements

This research was jointly supported NSFC funding(NO. 41371110,40921140410)and IIASA YSSP Program.

References Calibri

- Liu, J.Y. et al., (2005). Spatial and temporal patterns of China's cropland during 1990–2000: An analysis based on Landsat TM data. *Remote Sens. Environ.* 98, 442- 456.
- FAO/IIASA/ISRIC/ISSCAS/JRC (2012). *Harmonized World Soil Database (version 1.2)*. FAO, Rome, Italy and IIASA, Laxenburg, Austria.

Assessing Regional food security in the U.S. using crop models

*D. H. Fleisher*¹ – *J. P. Resop*² – *D. J. Timlin*¹ – *V.R. Reddy*¹

¹ Crop Systems and Global Change Laboratory, USDA-ARS, Beltsville, Maryland, USA, david.fleisher@ars.usda.gov

² Geographical Sciences, University of Maryland, College Park, Maryland, USA

Introduction

The United States northeastern seaboard region (NSR) imports roughly 65 to 80 % of fresh fruits and vegetables. The majority of these products are obtained from centralized and distantly located production centers. Reliance on outside food sources may increase vulnerability to risks related to escalating energy costs and product safety. Uncertainties due to projected population growth, urban development, and climate change present major challenges. Diversification of the regional food systems via development of regionally produced food may reduce some of these risks and stimulate rural development. The potential production capacity using the natural resource base is not known, but is an empirical question that can be addressed. To this end, a platform was developed that links crop models with geospatial data sets to evaluate production potential of various crops subject to biophysical constraints in this region (Resop et al., 2012, 2014), including climate change.

Materials and Methods

United States Department of Agriculture – Agricultural Research Service (USDA-ARS) crop models SPUDSIM and MAZSIM (for potato and maize, respectively) were linked with digital geospatial databases for the U.S. NSR using the PYTHON scripting language (Python Software Foundation, DE). A weather generator and soil hydraulic model were also embedded in the script. Databases included fine-scale (up to 16-m resolution) physical soil properties, land-use classification and crop cover data, and historical climatic data. Climate change values from monthly HadCM3 data (IPCC, 2007) were spatially and temporally downscaled and linked with a weather generator to simulate mid-century shifts in rainfall, temperature, and CO₂. Crop yield and water use efficiency responses were aggregated to the U.S. county spatial scale (typically in excess of 1km²). The process is indicated in Fig. 1.

Results and Discussion

Studies were conducted in the NSR with variations in land-use, water management, climate change, and planting / harvesting dates. Results showed a strong correlation between crop yields and water management. Corn and potato yields were 89 and 21 % higher in northern versus southern latitudes in rain-fed conditions, but such percentages declined to 39 % and 15 % when crops were managed with full irrigation. Mid-century climate change impacts varied by crop with declines of 52 % in potato and

20 % corn yields, assuming no adaptation measures were applied (Fig. 2). Further simulations showed that simple adaptation measures, including increased irrigation and/or adjustment of planting dates can reduce these potential yield losses by as much as 50 % depending on crop and geospatial location.

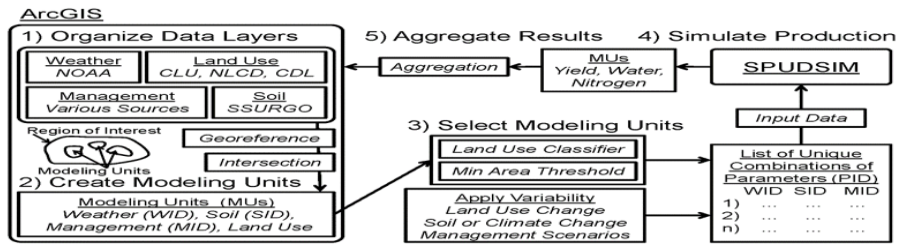

Figure 1. Geospatial methodology for scaling predictions to county scale (Resop et al., 2012)

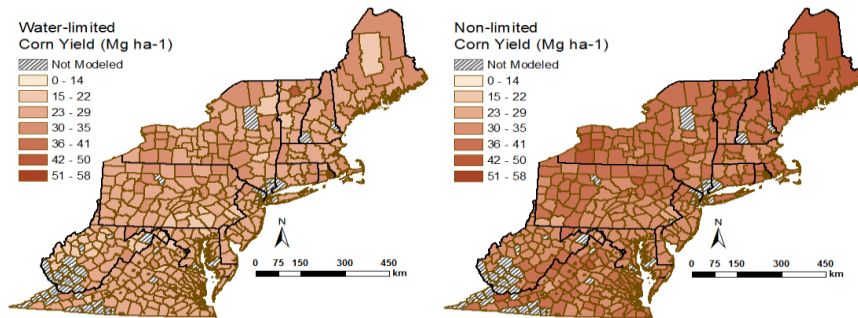

Figure 2. Corn yield under mid-century climate change for water-limited (left) and fully irrigated (right) simulations.

Conclusions

Production capacity in the U.S. seaboard region and the impacts of climate change were explored with the use of crop models and geospatial data. Results indicate crop yields were correlated with latitude. Climate change impacts were severe, but could be alleviated somewhat with simple adaptation measures. Future research directions will address additional commodities and adaptation measures in the region.

References

IPCC. (2007). *Climate Change 2007: The Physical Science Basis*. Contribution of Working Group I to the Fourth Assessment Report of the Intergovernmental Panel on Climate Change. Ed by. S. Solomon, D. Qin, M. Manning, Z. Chen, M. Marquis, K.B. Averyt, M. Tignor, and H.L. Miller. Cambridge, UK and New York, NY, USA: Cambridge University Press.

Resop, J. P., D. H. Fleisher, D. J. Timlin, and V. R. Reddy. (2014). Biophysical constraints to potential production capacity of potato across the U.S. eastern seaboard region. *Agronomy Journal* 106(1): 43–56.

Resop, J. P., D. H. Fleisher, Q. Wang, D. J. Timlin, and V. R. Reddy. (2012). Combining explanatory crop models with geospatial data for regional analyses of crop yield using field-scale modeling units. *Computers and Electronics in Agriculture* 89(1): 51–61.

Impacts of parameterization and input data on simulated yields in global gridded crop model frameworks

C. Folberth^{1,2} – *C. Müller*³ – *J. Elliot*^{4,5} – *A. Arneeth* – *J. Balković*¹ – *J. Chrystanthacopoulos*⁴ – *P. Ciais*⁷ – *D. Deryng*^{8,9} – *S. Hoek*¹⁰ – *T. Iizumi*¹¹ – *R. C. Izaurralde*^{12,13} – *C. D. Jones*¹² – *N. Khabarov*⁵ – *P. J. Lawrence*¹⁴ – *W. Liu*¹⁵ – *S. Olin*¹⁶ – *T. A.M. Pugh*⁴ – *D. K. Ray*¹⁷ – *A. Reddy*¹² – *C. Rosnztweig*¹⁸ – *A. C. Ruane*^{18,4} – *G. Sakurai*¹⁹ – *E. Schmid*²⁰ – *X. Wang*^{6,21} – *A. de Wit*¹⁰ – *X. Wu*⁶

¹International Institute for Applied Systems Analysis, Ecosystem Services and Management Program, 2361 Laxenburg, Austria; ²Ludwig Maximilian University, Department of Geography, 80333 Munich, Germany; c.folberth@lmu.de; ³Potsdam Institute for Climate Impact Research; ⁴Columbia University, Center for Climate Systems Research; ⁵University of Chicago, Computation Institute; ⁶Karlsruhe Institute of Technology, IMK-IFU; ⁷Institute Pierre Simon Laplace, Laboratoire des Sciences du Climat et l'Environnement; ⁸Grantham Research Institute on Climate Change & the Environment, London School of Economics and Political Sciences; ⁹University of East Anglia, School of Environmental Sciences, Climatic Research Unit; ¹⁰Alterra Wageningen University and Research Centre, Earth Observation and Environmental Informatics; ¹¹National Institute for Agro-Environmental Sciences, Agro-Meteorology Division, Japan; ¹²University of Maryland, Department of Geographical Sciences; ¹³Texas A&M University, Texas AgriLife Research and Extension; ¹⁴National Center for Atmospheric Research, Earth System Laboratory; ¹⁵Swiss Federal Institute of Aquatic Science and Technology; ¹⁶Lund University; ¹⁷University of Minnesota, Institute on the Environment; ¹⁸National Aeronautics and Space Administration, Goddard Institute for Space Studies; ¹⁹National Institute for Agro-Environmental Sciences, Ecosystem Informatics Division, Japan; ²⁰University of Natural Resources and Life Sciences, Austria; ²¹Peking University, Sino-French Institute of Earth System Sciences

Introduction

Recent years have seen vast growth in global gridded crop models (GGCMs) and their applications, mainly in climate change impact assessments (e.g. Rosenzweig et al., 2014) or crop management studies (e.g. Folberth et al., 2014). Typically, GGCMs are a combination of a field-scale crop model that calculates yields and externalities for each pixel of a given region and a model framework (MFW) that reads and transforms input data for running the field-scale model. The complexity of the field-scale models and agro-environmental algorithms is contrasted by the scarcity of management information available at the global scale. This requires assumptions or estimations of agricultural inputs and crop management, which can strongly differ among research groups. While past assessments have investigated differences in model outputs caused by using various climate datasets and/or various GGCMs (e.g. Rosenzweig et al., 2014), this study focuses on identifying the magnitude of differences caused by using various parameterizations and input datasets for simulations with the same field-scale model.

Materials and Methods

We evaluate simulated yields from five MFWs based on the field-scale model Environmental Policy Integrated Climate (EPIC; Williams et al., 1989) within the Global Gridded Crop Model Intercomparison (GGCMI) project (Elliott et al., 2015).

EPIC is an agronomic model with detailed routines for soil nutrient cycling and hydrology, various crop management operations and a wide range of crops. It allows for

selecting various methods for estimating evapotranspiration (ET), soil erosion and runoff. All MFWs were forced with the same set of climate observations, planting and harvest dates, and fertilizer application rates. Remaining differences in input data were soil characteristics and topography. The MFWs had been parameterized differently depending on the participating research groups' assumptions. Such parameters are turn-over rates for soil organic matter or soil erosion and ET coefficients among others. Results from the EPIC-based MFWs were also compared with those of a wider ensemble of MFWs based on other field-scale models or sets of algorithms but using the same harmonized input data described above.

Results and Discussion

First results show that the spread between the EPIC-based MFWs is smaller than that of the remaining MFWs. This can in part be explained by the purpose of simulating yield potential in some of the models and present day yields in others, the EPIC-MFWs among them.

Among the EPIC-MFWs, very large differences in yield magnitudes occur especially if different cultivars or crop types (e.g. spring or winter wheat) are grown in a given region. General differences in yield magnitudes can be explained by using different ET equations, which lead to higher or lower water requirements and associated deficits. Larger differences occur in grid cells in which fertilizer application rates are low and hence parameterization of soil nutrient supply and soil management are of high importance. The temporal pattern (positive or negative trends in the long run) of global yields is dominated by the selection of soil erosion mechanisms.

Conclusions

Presently, the use of various MFWs with differing assumptions and selections of input data allows for bracketing uncertainty related to model inputs to some extent. To provide more robust estimates of climate change impacts on and externalities of present agricultural systems, however, more detailed global crop management data (i.e. soil management, crop and fallow rotations, cultivar distribution) will be required.

References

- Folberth, C., H. Yang, T. Gaiser et al., (2014) Effects of ecological and conventional agricultural intensification practices on maize yields in sub-Saharan Africa under potential climate change. *Environ Res Lett* 9, 044004
- Elliott, J., C. Müller, D Deryng et al., (2015). The Global Gridded Crop Model Intercomparison: data and modeling protocols for Phase 1 (v1. 0). *Geoscientific Model Development* 8, 261-277.
- Rosenzweig, C., J. Elliott, D. Deryng et al., (2014). Assessing agricultural risks of climate change in the 21st century in a global gridded crop model intercomparison *PNAS* 111, 3268-3273.
- Williams, J.R., C.A. Jones, J.R. Kiniry, et al., (1989). The EPIC crop growth model. *Trans. ASAE* 32, 497-511.

Classifying simulated wheat yield responses to changes in temperature and precipitation across a european transect

S. Fronzek^{1} – N. Pirttioja¹ – T. R. Carter¹ – M. Bindi² – H. Hoffmann² – T. Palosuo² – M. Ruiz-Ramos² – F. Tao² – M. Trnka² – M. Acutis² – S. Asseng² – P. Baranowski² – B. Basso² – P. Bodin² – S. Buis² – D. Cammarano² – P. Deligios² – M.-F. Destain² – B. Dumont² – F. Ewert² – R. Ferrise² – L. François² – T. Gaiser² – P. Hlavinka² – I. Jacquemin² – K. C. Kersebaum² – C. Kollas² – J. Krzyszczak² – I. J. Lorite² – J. Minet² – M. I. Minguez² – M. Montesino² – M. Moriondo² – C. Müller² – C. Nendel² – I. Öztürk² – A. Perego² – A. Rodríguez² – A. C. Ruane² – F. Ruget² – M. Sanna² – M. A. Semenov² – C. Slawinski² – P. Stratonovitch² – I. Supit² – K. Waha² – E. Wang² – L. Wu² – Z. Zhao² – R. P. Rötter²*

¹ Finnish Environment Institute (SYKE), 00251 Helsinki, Finland; * Corresponding author

² Affiliations of co-authors as in Pirttioja et al., (2015)

Introduction

A wide variety of dynamic crop growth simulation models have been developed over the past few decades that can differ greatly in their treatment of key processes and hence in their response to environmental conditions. Here, multi-model ensemble approaches have been adopted to quantify aspects of uncertainty in simulating yield responses to climate change (e.g. Asseng et al., 2013). We use a large ensemble of wheat models applied at sites across a European transect to compare their sensitivity to changes in climate by plotting them as impact response surfaces (IRSs; Fronzek et al., 2010). A previous paper using the same simulated yield dataset (Pirttioja et al., 2015) presented ensemble medians and inter-quartile ranges, focusing on long-term averages. This paper extends that work by classifying the responses of individual models and attempting to interpret differences in response between groups of models by examining results from selected extreme years in addition to the long-term average.

Materials and Methods

An ensemble of 26 process-based crop models was used to simulate yields of winter and spring wheat at three sites: in Finland (mainly temperature-limited), Germany (close to optimal conditions) and Spain (precipitation limited). The sensitivity of simulated yield to systematic increments of changes in temperature (–2 to +9°C) and precipitation (–50 to +50 %) was tested by modifying values of baseline (1981 to 2010) daily weather. The results were plotted as IRSs that show the changes in yields relative to the baseline. IRSs of 30-year averages and selected extreme years were classified using a hierarchical clustering method and a second approach based on the location of the maximum yield and strength of the model response. IRSs were classified and compared to aspects of model performance, structure and genealogy (indicating the development history and relationships among some of the models).

Results and Discussion

Ensemble median responses showed declining yields with higher temperatures and decreased precipitation and yield increases with higher precipitation. However, individual models departed considerably from the average. An illustration of how responses are classified is given in Fig. 1, which distinguishes three patterns of winter wheat response across all three sites: (1) maximum yield at temperatures lower than the baseline, (2) stronger sensitivity to precipitation than temperature changes, and (3) large yield decreases with cooling and for strong warming. While some models were grouped into the same classes of response patterns for the different locations and crop varieties, a single factor could not be identified to explain common model responses. IRSs for anomalous weather-years showed larger model differences than for 30-year averages (e.g. in a cool year some models simulated crop failure over large parts of the IRS and others only small reductions relative to the baseline).

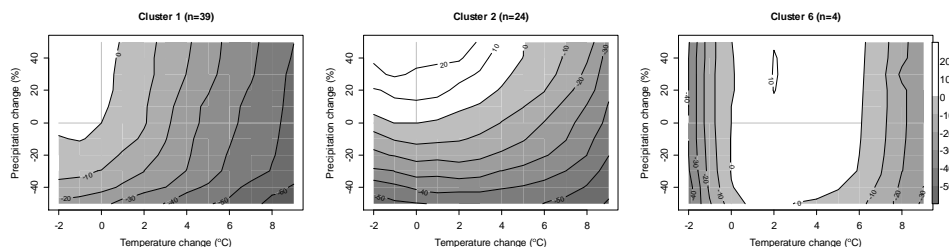

Figure 1. Ensemble mean changes in winter wheat grain yield (%) relative to the 1981-2010 baseline for the three dominant patterns of response identified using a hierarchical clustering approach across all study sites

Conclusions

At the time of writing, analysis of the modelled patterns of response were still ongoing. Preliminary results indicate that the study site is an important determinant of the positioning of the response pattern for a given crop with respect to baseline climate. Differences in the shape and strength of the response pattern, especially under high-end changes and in anomalous weather-years, appear to be related to the model representation of processes such as heat stress, moisture stress and vernalisation. Differences in calibration methods may also contribute to inter-model discrepancies.

Acknowledgements

This work is part of the FACCE-JPI Knowledge Hub MACSUR. For funding sources see Pirttioja et al., (2015).

References

- Asseng, S., F. Ewert, C. Rosenzweig et al., (2013). *Nature Climate Change* 3 (9): 827–32.
- Fronzek, S., T.R. Carter, J. Räisänen et al., (2010). *Climatic Change* 99 (3): 515–534.
- Pirttioja, N., T.R. Carter, S. Fronzek et al., (2015). *Climate Research*, 65: 87–105.

Evaluation of the STICS soil-crop model for modelling arable intercrops

N. Gaudio^{1*} – *D. Ripoché*² – *M. Launay*² – *H. Tribouillois*¹ – *E. Justes*¹

¹ INRA, UMR 1248 AGIR, INRA-INP-ENSAT, F-31326 Castanet-Tolosan

² INRA, US 1116 Agroclim, F-84914 Avignon

* Noemie.Gaudio@toulouse.inra.fr

Introduction

STICS is a generic crop model that simulates the effect of climate, soil and crop management on yield and on environmental issues (e.g. Brisson et al., 2008). It was initially devoted to sole crops modelling (STICS-SC) but was also adapted to intercrops (STICS-IC) including two species in alternate rows (Brisson et al., 2004). This development was done in accordance with recent global change and environmental issues as intercropping could be one strategy to solve some problems linked to modern intensive agriculture (Brooker et al., 2015). One of the concepts behind this agricultural transition is that species coexistence in a same field could improve the resource use efficiency via the processes of niche complementarity and facilitation. It was illustrated in few studies, particularly in cereal-legume intercrops in low fertilization conditions (e.g. Bedoussac et al., 2015; Hauggaard-Nielsen et al., 2009). However, intercropping modelling requires considering ecological processes that are not usually included in crop models. The STICS-IC model was already used for simulating different intercrops in various European conditions and analyse in silico their performances (Launay et al., 2009; Shili-Touzi et al., 2010). The goal of this paper is to give a brief overview of the formalisms especially developed in STICS-IC to take into account species interactions for various types of intercrops, and to provide some trails in order to improve the formalisms.

Formalisms and limits in STICS-IC

By an extrapolation of a sole crop model, STICS-IC relies on the crop division into two parts: the dominant (higher) species and the understorey (smaller) one. Light resource is then partitioned between the two species using an energy balance taking into account the dominance of the two species for distributing the direct and diffuse light and its interception by the two species, with a possible species dominance inversion during the crop season (Brisson et al., 2004). Light amount, coupled with a resistive scheme taking into account evapotranspiration processes, allows to estimate the water requirements of each species. The nitrogen acquisition is also simulated dynamically according to each crop demand and the soil offer which is determined by the root density and depth of each species. For cereal-legume intercrops, the model is able to simulate niche complementarity for nitrogen resource thanks to the simulation of N₂ fixation of legume and the effect of soil nitrate content on N₂ fixation rate; consequently if the cereal grows and uptakes faster available soil mineral-N, the legume N₂ fixation is boosted due to a lower inhibition of biological fixation by nitrate content.

Therefore, in a certain way, STICS-IC includes resource partitioning between the two coexisting species. Nevertheless, it has been shown that even if STICS-IC is quite satisfactory to simulate intercrop growth, few points need to be improved (Corre-Hellou et al., 2009; Launay et al., 2009). In particular, simulation of canopy height, from which depends light competition, should receive a particular attention. Moreover, there is no horizontal heterogeneity in the soil whereas some species particularly competitive for soil resources are able to colonize soil zones already occupied by another species. We analysed the formalisms of STICS-IC using published data on durum wheat-winter pea intercrops (Bedoussac and Justes, 2010) in order to identify which concepts and equations developed in the model should be changed in order to improve the simulation without strong modifications. Our results indicate that the model could be efficient for some intercrop designs (e.g. in alternate rows) but a more detailed modelling approach, spatially distributed, is required for other sowing designs.

Finally, depending on the limiting resource and the plant strategy (resource conservation versus acquisition), the different species are able to adapt differently. For example, if water is the main limiting factor, some species can increase carbon allocation to roots comparatively to aerial parts in order to counterbalance this lack. These kinds of ecological adaptations and processes should be included in an intercropping model. Therefore, the question directly deriving from this remark is: can they be integrated in a non-spatialized model such as STICS-IC or should we bring to the model the spatial heterogeneity using for example a spatialized discretization in the model?

References

- Bedoussac, L., E.-P. Journet, H. Hauggaard-Nielsen et al., (2015). *Agronomy for Sustainable Development*, 35: 911-935.
- Bedoussac, L., E. Justes (2010). *Plant Soil*, 330: 19-35.
- Brisson, N., M. Launay, B. Mary, N. Beaudoin (2008). Editions Quae, Versailles, 300 pp.
- Brisson, N., F. Bussiere, H. Ozier-Lafontaine et al., (2004). *Agronomie*, 24: 409-421.
- Brooker, R.W., A.E. Bennett, W.-F. Cong et al., (2015). *New Phytologist*, 206: 107-117.
- Corre-Hellou, G., M. Faure, M. Launay et al., (2009). *Field Crops Research*, 113: 72-81.
- Hauggaard-Nielsen, H., M. Gooding, P. Ambus et al., (2009). *Nutrient Cycling in Agroecosystems*, 85: 141-155.
- Launay, M., N. Brisson, S. Satger et al., (2009). *European Journal of Agronomy*, 31: 85-98.
- Shili-Touzi, I., S. De Tourdonnet, M. Launay, T. Dore (2010). *Fields Crops Research*, 116: 218-229.

Meteorological risks and crop yield modelling

A. Gobin¹ – H. van de Vyver²

¹ Flemish Institute for Technological Research, Belgium

² Royal Meteorological Institute, Belgium

Introduction

Extreme and adverse weather events such as late or early frosts, droughts, heat waves and rain storms can have devastating effects on cropping systems. Damages due to extreme or adverse weather are strongly dependent on crop type, crop stage, soil type and soil conditions. The impact is largest during the sensitive periods of the farming calendar, and requires a crop modelling approach to capture the interactions between the crop, its environment and the occurrence of the meteorological event. We hypothesize that extreme and adverse weather events can be quantified and subsequently incorporated in current crop models.

Materials and Methods

Since crop development is driven by thermal time and photoperiod, we used a regional crop model (Gobin, 2010) to examine the likely frequency, magnitude and impacts of frost, drought, heat stress and waterlogging in relation to the cropping season and crop sensitive stages. Risk profiles and associated return levels were obtained by fitting generalized extreme value distributions to block maxima for single (e.g. temperature: Van de Vyver, 2012) and composite meteorological indicators (e.g. drought: Zamani et al., 2016). We performed a similar analysis for air humidity variables and water balances. The risk profiles were subsequently confronted with yields and yield losses for the major arable crops in Belgium, notably winter wheat, winter barley, winter oilseed rape, sugar beet, potato and maize. Yields were obtained from regional statistics, the farm accountancy network and farmers' organizations. Meteorological data were obtained from the Royal Meteorological Institute.

Results and Discussion

The average daily vapour pressure deficit (*VPD*) and reference evapotranspiration (*ET₀*) during the growing season is significantly lower ($p < 0.001$) and has a higher variability before 1988 than after 1988. The sum of vapour pressure deficit during the growing season is the single best predictor of arable yields in Belgium (Gobin, 2012). Distribution patterns of *VPD* have relevant impacts on crop yields. The air humidity variables have physically-based limits with basic relationships between temperature, humidity and pressure: the *VPD* increases exponentially with rising temperature at a constant relative air humidity and increased *ET₀* occurs at warm temperatures. The maximum *VPD* and *ET₀* during sensitive stages of arable crops is significantly different between the period 1947–1987 and 1988–2012 (Figure 1). The response to rising temperatures depends on the crop's capability to condition its microenvironment.

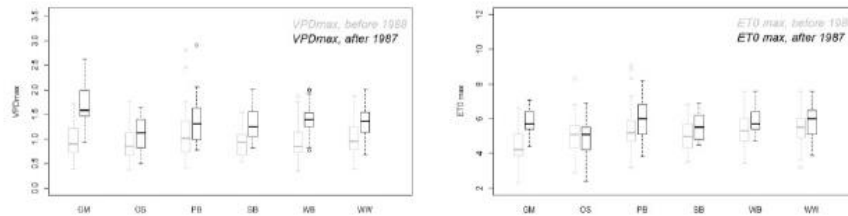

Figure 1. Magnitude of maximum vapour pressure deficit (VPD) and reference evapotranspiration (ET0) during sensitive crop stages of arable crops in Belgium during the period 1947-1987 and 1988-2012. GM = grain maize, OS = oilseed rape, PB = late potato, SB = sugarbeet, WB = winter barley, WW = winter wheat.

Crops short of water close their stomata, lose their evaporative cooling potential and ultimately become susceptible to heat stress. Effects of heat stress therefore have to be combined with moisture availability such as the precipitation deficit (Figure 2) or the soil water balance. Risks of combined heat and moisture deficit stress appear during the summer. These risks are subsequently related to model crop damage.

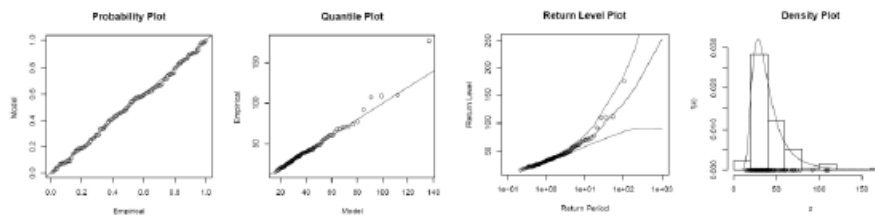

Figure 2. Generalised Extreme Value fit to maximum precipitation deficit (mm) during the period 1901-2012.

Conclusions

The methodology of defining meteorological risks and subsequently relating the risk to the cropping calendar was demonstrated for major arable crops in Belgium. Physically based crop models assist in understanding the links between adverse weather events, sensitive crop stages and crop damage.

Acknowledgements

Financial support was obtained from Belspo under research contract SD/RI/03A (MERINOVA: meteorological risks as drivers of innovation for agroecosystem management).

References

- Gobin, A. (2010). Modelling climate impacts on arable yields in Belgium. *Climate Research* 44: 55–68.
- Gobin, A. (2012). Impact of heat and drought stress on arable crop production in Belgium. *Natural Hazards and Earth System Sciences* 12, 1911–1922.
- Zamani, S., Gobin, A., Van de Vyver, H. (2015). Atmospheric drought in Belgium: statistical analysis of precipitation deficit. *International Journal of Climatology*, in press.

Simulation of the the landscape scale nitrogen cycling and redistribution with the coupled hydrology biogeochemistry model CMF-LandscapeDNDC

E. Haas¹ – S. Klatt¹ – R. Kiese¹ – K. Butterbach-Bahl¹ – P. Kraft² – L. Breuer²

¹ Karlsruhe Institute of Technology (KIT), Institute of Meteorology and Climate Research – Atmospheric Environmental Research, Kreuzteckbahnstraße 19, 82467 Garmisch-Partenkirchen, DE

² University of Giessen, Institute of Landscape Ecology and Resources Management, Heinrich-Buff-Ring 26, 35392 Giessen, DE

Introduction

The use of mineral nitrogen fertilizer sustains the global food production and therefore the livelihood of human kind. The rise in world population will put pressure on the global agricultural system to increase its productivity leading most likely to an intensification of mineral nitrogen fertilizer use. The fate of excess nitrogen and its distribution within landscapes is manifold. Process knowledge on the site scale has rapidly grown in recent years and models have been developed to simulate carbon and nitrogen cycling in managed ecosystems on the site scale. Despite first regional studies, the carbon and nitrogen cycling on the landscape or catchment scale is not fully understood. In this study we present a newly developed modelling approach by coupling the fully distributed hydrology model CMF (catchment modelling framework) to the process based regional ecosystem model LandscapeDNDC for the investigation of interaction of hydrological processes and carbon and nitrogen transport and cycling. The study focused on water and nutrient displacement and resulting greenhouse gas emissions in a virtual catchment.

Materials and Methods

The catchment consists of several hundred polygons vertically stratified into soil layers. Ecosystem states (soil water and nutrients content) and fluxes (percolation, interflow and evapotranspiration) are exchanged between the models at high temporal scales (hourly) forming a 3-dimensional model system at catchment scale. The water flux and nutrients transport in the soil is modelled using a 3D Richards/Darcy approach for subsurface fluxes with a kinematic wave approach for surface water runoff and the evapotranspiration is based on Penman-Monteith. Biogeochemical processes are modelled by LandscapeDNDC, including soil microclimate, plant growth and biomass allocation, organic matter mineralisation, nitrification, denitrification, chemodenitrification and methanogenesis producing and consuming soil based greenhouse gases. The landscape hosts intensively and extensively managed arable and grassland ecosystems and illustrates the effect of coupled process-based modelling including fertilizer induced direct N₂O emissions, hydrological nutrient transport and redistribution, productivity gradients and indirect N₂O emissions due to nutrient displacement and the effect of buffer strips for nutrient retention into open waters at catchment scale.

The model application will also present the effects of different management practices (fertilization rates and timings, tilling, residues management) on the redistribution of N surplus within the catchment.

For validation we will use a virtual hillslope of 1 hectare size decomposed into 20 x 20 grid cells. The domain was elevated on one edge and outlet boundary conditions were defined on all grid cells on the downhill side forming an 3-dimensional virtual hillslope. Input data (7 year crop rotation) from a well observed experimental arable site from INRA Grignon (France) was used to setup LandscapeDNDC within the coupled model such that we can evaluate model results with field observations using yields, soil inorganic nitrogen (NO_3 and NH_4) and N_2O and NO emission measurements.

Results and Discussion

The newly developed coupled modeling system is able to predict field observations for the experimental site in good agreement. The model predicted simulated yields with spatial variability of up to 10 % due to the nutrient redistribution on the catchment. The coupled model produced aerobic conditions on the uphill and anaerobic conditions due to soil water saturation downhill and at the riparian zone. The coupled simulations reproduced soil nutrient gradients along the hillslope due to the strong denitrification at the downhill slope and in the riparian zone resulting in low nitrate concentrations and high N_2 emissions. Nitrate leaching out of the domain via the outlet boundary conditions vary between 5 and 10 % of the average N fertilizer applied during the rotation depending on slope, outlet configuration and buffer strip vegetation used in the scenarios.

We will present first results of simulations of a German catchment of approx. 10 km² of arable, grassland and forest ecosystems where we performed discharge and nitrate measurements as well as greenhouse gas measurements along the hill slopes for model validation.

A third application will illustrate nutrient transport in paddy rice terrace fields of moderate slopes simulated with the coupled modeling system.

Conclusions

The study gives an indication of feedback mechanisms in the nitrogen cycle on the landscape scale and the excess pathways of reactive nitrogen in arable systems.

Acknowledgements

The study was funded by the German Science Foundation.

Analysing data aggregation effects on large-scale yield simulations

H. Hoffmann^{1*} – G. Zhao¹ – S. Asseng² – M. Bindi³ – D. Cammarano⁴ – J. Constantin⁵ – E. Coucheney⁶ – R. Dechow⁷ – L. Doro⁸ – H. Eckersten⁹ – T. Gaiser¹ – B. Grosz⁷ – E. Haas¹⁰ – B. Kassie² – K. C. Kersebaum¹¹ – R. Kiese¹⁰ – S. Klatt¹⁰ – M. Kuhnert¹² – E. Lewan⁶ – M. Moriondo¹³ – C. Nendel¹¹ – H. Raynal⁵ – P. P. Roggero⁸ – R. Rötter¹⁴ – S. Siebert¹ – C. Sosa⁶ – X. Specka¹¹ – F. Tao¹⁴ – E. Teixeira⁵ – G. Trombi³ – J. Yeluripati¹⁶ – E. Vanuytrecht¹⁷ – D. Wallach⁵ – E. Wang¹⁸ – L. Weihermüller¹⁹ – Z. Zhao¹⁸ – F. Ewert¹

¹ Crop Science Group, INRES, University of Bonn, Katzenburgweg 5, 53115 Bonn, DE

² Agricultural & Biological Engineering Department, University of Florida, Frazier Rogers Hall, Gainesville, FL 32611, USA

³ Department of Agri-food Production and Environmental Sciences - University of Florence, Piazzale delle Cascine 18, 50144 Firenze, IT

⁴ The James Hutton Institute, Invergowrie Dundee DD2 5DA, Scotland UK

⁵ INRA, UMR 1248 AGIR & UR0875 MIA-T, F-31326 Castanet-Tolosan, FR

⁶ Biogeophysics and water quality, Department of Soil and Environment, Swedish University of Agricultural Sciences, Lennart Hjelm's väg 9, 750 07 Uppsala, SE

⁷ Thünen-Institute of Climate-Smart-Agriculture, Bundesallee 50, 38116 Braunschweig, DE

⁸ Desertification Research Group, Università degli Studi di Sassari, Viale Italia 39, 07100 Sassari, IT

⁹ Department of Crop Production Ecology, Swedish University of Agricultural Sciences, Ulls väg 16, 750 07 Uppsala, SE

¹⁰ Institute of Meteorology and Climate Research – Atmospheric Environmental Research, Karlsruhe Institute of Technology, Kreuzackbahnstraße 19, 82467 Garmisch-Partenkirchen, DE

¹¹ Institute of Landscape Systems Analysis, Leibniz Centre for Agricultural Landscape Research, 15374 Müncheberg, DE

¹² Biological and Environmental Sciences, School of Biological Sciences, University of Aberdeen, 23 St Machar Drive, Aberdeen AB24 3 UU, Scotland, UK

¹³ Marco Moriondo, CNR-Ibimet, Via Madonna del Piano 10, 50019 Sesto Fiorentino, Italy

¹⁴ Climate Impacts Group, Natural Resources Institute Finland (Luke), 00790 Helsinki, FI

¹⁵ Systems Modelling Team (Sustainable Production Group), The New Zealand Institute for Plant and Food Research Limited, Canterbury Agriculture & Science Centre, Gerald St, Lincoln 7608, NZ

¹⁶ The James Hutton Institute, Craigiebuckler, Aberdeen, AB15 8 QH, UK

¹⁷ Division Soil & Water Management, KU Leuven, Celestijnenlaan 200E, PO 2411, 3001 Heverlee, BE

¹⁸ CSIRO Land and Water, Clunies Ross Street, Canberra, ACT, AU

¹⁹ Institute of Bio- & Geosciences Agrosphere (IBG-3), Forschungszentrum Jülich, 52425 Jülich, DE

* hhoffmann@uni-bonn.de

Introduction

Large-scale yield simulations often use data of coarse spatial resolution as input for process-based models (Ewert et al., 2015; Zhao et al., 2015). However, using aggregated data as input for process-based models entails the risks of introducing errors linked to aggregation effects (AE) such as: i) data modification; ii) missing the valid range of the model; iii) data inconsistencies between data types. While the regional crop yield bias is usually <5 % on average over all years, it may increase to more than 10 % under specific conditions, e.g. in single years (Hoffmann et al., 2015), depending on the model. In order to assess these differences in detail, we present a model intercomparison on AE for a range of environmental conditions differing in climate and soil for two crops grown under three different production situations.

Materials and Methods

Multi-model ensemble runs were conducted with soil and climate input data at resolutions from 1 to 100 km for the state of North Rhine-Westphalia, Germany. Climate data was spatially averaged. Soil data was aggregated by area majority. Winter wheat and silage maize yields of 1982-2011 were simulated with 11 models for potential, water-limited and water-nitrogen-limited production after calibration to average regional sowing date, harvest date and crop yield.

Results and Discussion

Regional yields were reproduced by the models on average, regardless of input data type and resolution. However, *AE* were observed in dry years as well as due to soil aggregation. Large positive *AE* between coarser and 1 km resolutions were associated with low soil water holding capacity (SWHC) and low climatic water balance (CWB) at 1 km resolution in combination with increases in SWHC and CWB when aggregating to coarser resolutions. Consistently, the opposite was found for large negative *AE*. Large *AE* (larger/lower mean +/-2 standard deviations of *AE*) were due to changes in soil type. However, the lower 50 % of all *AE* also showed differences in the aggregation method: soil aggregation by majority led to about 20 % of grid cells with no *AE* at 100 km resolution whereas climate data aggregation by averaging always led to *AE*. Still, soil aggregation by majority led to a larger fraction of *AE* larger than 10 % as compared to climate averaging. Notably, this was further increased by the combined use of aggregated soil and climate data. Finally, models differed considerably in *AE*.

Conclusions

The results highlight the interactions between model, data and aggregation method with *AE*, emphasizing the importance of models intercomparison analyses.

Acknowledgements

The study was conducted in the frame of the FACCE JPI MACSUR and received funding from several national institutions. Please see Hoffmann et al., (2015) and Zhao et al., (2015) for further details on funding.

References

- Hoffman, H., G. Zhao, L.G.J. Van Bussel et al., (2015). *Climate Research*, doi: 10.3354/cr01326.
- Ewert F., L.G.J. Van Bussel, G. Zhao et al., (2015). In: Rosenzweig, C. and Hillel, D: *Handbook of Climate Change and Agroecosystems*. Imperial College Press, London, UK, 261-277.
- Zhao, G., H. Hoffmann, L.G.J. Van Bussel et al., (2015). *Climate Research*, doi: 10.3354/cr01301.

Climate impacts on grain maize in Switzerland – Do the results from three different modelling approaches agree?

*A. Holzkämper*¹ – *P. Calanca*¹ – *M. Honti*² – *J. Fuhrer*¹

¹ Climate and Air Pollution Group, Institute for Sustainability Sciences, Agroscope, Reckenholzstr. 191, CH-8046 Zurich, Switzerland, e-mail: annelie.holzkaemper@agroscope.admin.ch

² MTA-BME Water Research Group, Hungarian Academy of Sciences, H-111 Muegyetem rkp. 3, Budapest, Hungary

Introduction

Structural model uncertainties are increasingly being investigated in recent impact studies (e.g. Asseng et al., 2013). However, agro-climate ensembles including different crop modelling approaches have not been applied to our knowledge so far.

In this study, we applied for the first time three fundamentally different modelling approaches in an impact assessment ensemble: a statistical crop model, a process-based crop model and a recently developed hybrid approach for estimating climate suitability. Based on these approaches, we investigated climate impacts on yield potentials and climatic limitations for grain maize in Switzerland.

Materials and Methods

This impact study was conducted at three sites located in different climatic regions in Switzerland: Magadino (MAG), located south of the Alps (1832 mm average annual precipitation, 11.4°C average annual temperature), Payerne (PAY) in Western Switzerland (891 mm, 9.4°C), and Wädenswil (WAE) in the North-East (1390 mm, 9.5°). Observed weather data were available from the Swiss Federal Office of Meteorology and Climatology (MeteoSwiss, 1981-2010). Climate projections from different ENSEMBLES model chains for the time horizon 2035-2064 were downscaled for the three sites.

CropSyst, which had been calibrated for Swiss conditions (Klein et al., 2012) was applied as the representative for a process-based crop model. A statistical crop model was fitted based on the same data that had been used for calibrating CropSyst and the hybrid climate suitability evaluation approach (Holzkämper et al., 2013). All three approaches were applied with different parameterisations to account of impact model parameter uncertainty. Changes in yield and climatic limitations were derived from model estimates under baseline climate and for climate projections.

Results and Discussion

Yield changes projected with the agro-climate ensemble for the time horizon 2035-2064 are highly uncertain with the largest source of uncertainty being the impact model approach (Fig. 1). However, despite high uncertainty in estimated yield changes, projections of climatic limitations are largely consistent amongst the three approaches (Fig. 2).

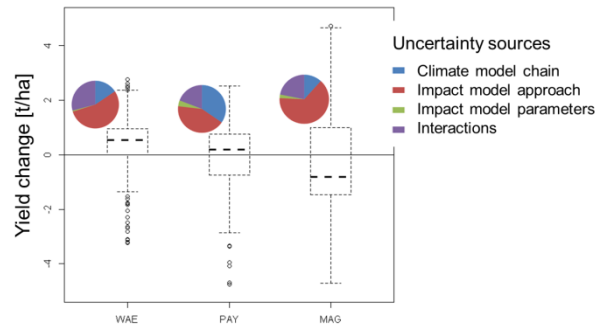

Figure 1. Projected changes in average grain maize yield and associated uncertainties (uncertainties partitioned based on ANOVA; WAE = Wädenswil, PAY = Payerne, MAG = Magadino).

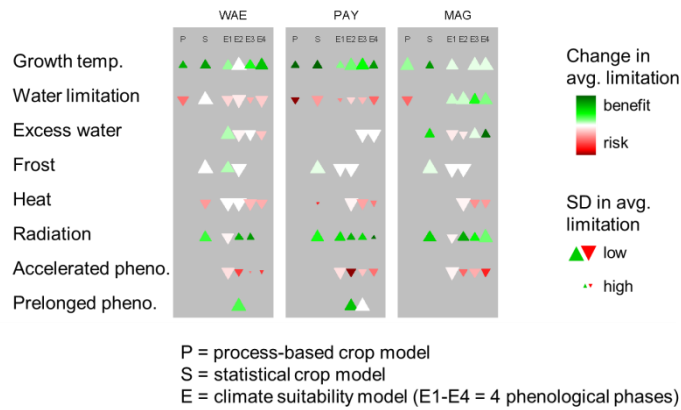

Figure 2. Summary of changes in climatic limitations derived with the three crop model approaches (E1-E4 = four phenological phases of grain maize growth: sowing to emergence, emergence to beginning of flowering, beginning to end of flowering, end of flowering to maturity; SD = standard deviation)

Conclusions

We conclude that projections of climate limitations are not only more consistent between the approaches, but also more informative for adaptation planning than projections of yield changes alone. Where projected yield changes suggest that the sites remain generally suitable for grain maize cultivation, demands for adaptations to climate change can be identified based on analysed climatic limitations (e.g. irrigation to reduce drought and heat stress, choice of varieties with adapted phenology).

References

Asseng, S., Ewert, F., Rosenzweig, C., Jones, J.W., Hatfield, J.L., Ruane, A.C. et al., (2013). Uncertainty in simulating wheat yields under climate change. *Nature Climate Change*.
 Klein, T., Calanca, P., Holzkämper, A., Lehmann, N., Roesch, A. and Fuhrer, J. (2012). Using farm accountancy data to calibrate a crop model for climate impact studies. *Agricultural Systems*, 111: 23-33.
 Holzkämper, A., Calanca, P. and Fuhrer, J. (2013). Identifying climatic limitations to grain maize yield potentials using a suitability evaluation approach. *Agricultural and Forest Meteorology*, 168: 149– 159.

Filling caveats in yield gap analysis

*M. van Ittersum*¹ – *R. Schils*¹ – *W. van der Werf*² – *G. van de Ven*¹ – *A. van der Linden*^{1,3}
– *K. Giller*¹ – *M. van Noordwijk*^{1,4}

¹ Plant Production Systems, Wageningen University, email: martin.vanittersum@wur.nl

² Centre for Crop Systems Analysis, Wageningen University

³ Animal Production Systems, Wageningen University

⁴ World Agroforestry Centre (ICRAF), Bogor, Indonesia

Introduction

Yield gap analysis has been a well known notion in crop science since the late 1980s, but it has become popular only recently. It is generally regarded a helpful starting point for mapping the opportunities for sustainable intensification of agricultural systems. Different methods exist to quantify and map yield gaps of our major food crops grown as sole crops (Van Ittersum et al., 2013). In significant parts of the world (e.g. in Sub-Saharan Africa and China), however, crops are not grown as sole crops, but in intercropping systems. This clearly complicates yield gap assessment. Also, at least 30 % of the cereals is fed to livestock and livestock products constitute a major and increasing share of our diets. Many of the world's agricultural systems are in fact crop-livestock systems. Finally, perennial crops are an important source of our nutrition and a component of agricultural systems that increases in relevance. How can the yield gap notion be applied to such more integrated or complex systems and how does it drive model development? Before addressing this question we briefly summarize a global approach with local relevance for sole crops, setting the scene for other systems.

A global approach with local relevance for yield gap analysis of food crops

In the global yield gap atlas project (GYGA – www.yieldgap.org) a global protocol has been developed using a climate zonation, crop area masks, local weather data and the key soil (in particular soil water holding capacity and rootable soil depth) and cropping system information (sowing dates, cultivars, etc.) for the hot spots of crop production, combined with data on observed actual farmers' yields (Grassini et al., 2015; Van Bussel et al., 2015). Crop models are used to assess potential or water-limited potential yields. The global protocol is always applied with local data and local experts are involved in the evaluation of modelling and yield gap analysis results. It has now been applied to 25 countries and another ca. 20 countries are on their way, thus creating a unique database (www.yieldgap.org).

Intercrops

Examples of important intercropping systems are wheat-maize, wheat-soybean and maize-cotton intercroppings. Such systems often have a land equivalent ratio >1, which makes them efficient in terms of land use. Yield gap analysis for these systems is complex because statistics usually do not discriminate between sole and intercroppings (also affecting reported yields of sole crops) and because estimation of potential yields re-

quires a different type of (inter)crop growth model. In this Symposium Gou et al., present an intercrop model accounting for the light interception of rows of (different) crops. This model allows the assessment of potential yields of intercrops with a given row configuration. It remains a challenge, however, to find the optimum row configuration of intercrops and thus to define the 'potential' yield of a given intercrop.

Livestock production and crop-livestock systems

Building upon the work of Van de Ven et al., (2003), Van der Linden et al., (2015) translated the concepts of potential, limited and actual yields, as well as yield gaps to livestock production. They are also developing a dynamic simulation model that allows the estimation of potential and feed-limited (both quality and quantity) beef production levels of different breeds in different climates. An additional challenge in livestock production is the upscaling from individual animals to the (management) unit of a herd. While livestock production and yield gaps can be expressed per animal, per unit of animal body mass or per unit of feed intake, it is to be expressed in kg livestock product ha⁻¹ year⁻¹ from the integrated crop-livestock perspective. The combined use of crop and livestock production models allows the analysis of crop-livestock systems.

Perennial crops

Perennial crops have features of scaling (from trees to canopies and replacement; single season to multi-years) and challenges with experimentation in common. Recently an oil palm model with monthly time steps and for potential growing conditions has been developed to assess yield gaps of oil palm plantations (Hoffman et al., 2014). This approach will be further developed and applied to cocoa and other perennial systems.

In conclusion

In the presentation these advances in yield gap analysis methods will be presented and illustrated. Common denominators, such as land equivalent ratios, and challenges, including scaling and the use of (local) data will be discussed.

References

- Hoffman, M.P., Castaneda Vera, A., Van Wijk, M.T., Giller, K.E., Oberthur, T., Donough, C., Whitbread, A.M. (2014). Simulating potential growth and yield of oil palm (*Elaeis guineensis*) with PALMSIM: Model description, evaluation and application. *Agricultural Systems*, 131, 1-10.
- Van Bussel, L.G.J., Grassini, P., Van Wart, J., Wolf, J., Claessens, L., Yang, H., Boogaard, H., de Groot, H., Saito, K., Cassman, K.G., van Ittersum, M.K. (2015). From field to atlas: Upscaling of location-specific yield gap estimates. *Field Crops Research* 177, 98-108.
- Van de Ven, G.W.J., De Ridder, N., Van Keulen, H., Van Ittersum, M.K. (2003). Concepts in production ecology for analysis and design of animal and plant-animal production systems. *Agricultural Systems* 76, 507-525.
- Van der Linden, A., Oosting, S.J., van de Ven, G.W.J., de Boer, I.J.M., van Ittersum, M.K. (2015). A framework for quantitative analysis of livestock systems using theoretical concepts of production ecology. *Agricultural Systems* 139, 100-109.
- Van Ittersum, M.K., Cassman, K.G., Grassini, P., Wolf, J., Tiftonell, P., Hochman, Z. (2013). Yield gap analysis with local to global relevance—A review. *Field Crops Research* 143, 4-17.

Integrated crop water management might sustainably halve the global food gap

J. Jägermeyr¹ – D. Gerten¹ – S. Schaphoff¹ – J. Heinke^{1,2} – W. Lucht^{1,4}

¹ Research Domain Earth System Analysis, Potsdam Institute for Climate Impact Research (PIK), Telegrafenberg A62, 14473 Potsdam, Germany

² International Livestock Research Institute (ILRI), P.O. Box 30709, Nairobi, 00100 Kenya

³ Commonwealth Scientific and Industrial Research Organization (CSIRO), St. Lucia, QLD 4067, Australia

⁴ Geography Department, Humboldt-Universität zu Berlin, Unter den Linden 6, 10099 Berlin, Germany
Correspondence: jonas.jaegermeyr@pik-potsdam.de

Introduction

As planetary boundaries are being approached rapidly, humanity has little room for additional expansion and conventional intensification of agriculture, while a growing world population further spreads the food gap. Improved on-farm water management can close water-related yield gaps ecologically and to a considerable degree, but its global significance remains unclear. In this modeling study we investigate systematically to what extent integrated crop water management might contribute to closing the global food gap, constrained by the assumption that pressure on water resources and land does not increase.

Materials and Methods

Using a process-based bio-/agrosphere model, we simulate the yield-increasing potential of elevated irrigation water productivity (including irrigation expansion with thus saved water) and optimized use of *in situ* precipitation water (alleviated soil evaporation, enhanced infiltration, supplemental irrigation) for current and projected future climate (from 20 climate models, four CO₂ concentration pathways, and different CO₂ fertilization effects). Respective water management interventions are simulated in a mechanistic way based on a novel degree of process-detail and high spatio-temporal resolution.

Results and Discussion

Results show that irrigation improvements can save substantial amounts of water in many river basins (>30 % of non-productive water consumption, in a "best-practice" scenario), and if rerouted to neighboring rainfed systems, can boost yields significantly (4-14 % global increase). Low-tech solutions for small-scale farmers on water-limited croplands show the potential to increase rainfed yields to a similar extent. In combination, the here studied ambitious, yet achievable integrated water management strategies could increase global production by 40 % and close the water-related yield gap by 62 %. Unabated climate change will have adverse effects on crop yields in many regions, but water management as analyzed here can buffer such effects to a significant degree.

Conclusions

Simulated yield gains might be sufficient to halve the global food gap by 2050 on a sustainable basis. Overall, this study highlights, development goals that fail focusing on systematic implementation of crop water management, substantially miss opportunities to reduce pressure on planetary boundaries, while advancing a sustainable food system and its climate resilience.

The abiotic and biotic impacts of climate change on potato agriculture

S. Jennings¹ – A.-K. Koehler¹ – S. Sait² – A. Challinor¹

¹ Institute for Climate and Atmospheric Science, School of Earth and Environment, University of Leeds, School of Earth and Environment, Maths/Earth and Environment Building, The University of Leeds, Leeds, LS2 9JT, United Kingdom, e-mail: eesaj@leeds.ac.uk

² School of Biology, University of Leeds
Corresponding author: Stewart Jennings

Introduction

Potato production is increasing globally, meaning that potatoes are likely to become more important for achieving global food security in the coming decades. As well as being vulnerable to heat and water stress, potatoes suffer badly from pest attack, with global average yield losses due to pests calculated to be 40.3 %, compared to, for example, 28.3 % for wheat (Oerke, 2006). The majority of crop models do not account for pest damage (Rivington and Koo, 2011), meaning that many predictions for the impacts of climate change on yields are greatly uncertain in this respect. This study looks at two regional case studies - the UK and Colombia – in order to ascertain how abiotic and biotic factors will impact potato yields in contrasting environments with climate change.

Materials and Methods

A process-based crop model was developed for the simulation of the potato crop. It was based on the General Large Area Model for annual crops (GLAM - Challinor et al., 2004). This model was used alongside the SimCast model (Sparks et al., 2011) which measures the risk of stress on the potato crop caused by late blight (*Phytophthora infestans*) – the most important biotic stress of potatoes globally. It does so using “blight units”, which are calculated using the consecutive hours in a day where relative humidity is over 90 %, the temperature during those hours and the susceptibility of potato cultivars to blight. Areas where yields are predicted to decrease and blight risk projected to increase in the UK and Colombia through to 2050 were identified using 5 bias-corrected models from the CMIP5 ensemble (Taylor et al., 2012), measuring uncertainty across RCPs and GCMs. Irrigated and rainfed potato growing areas were accounted for (Portman et al., 2010). The impacts on yields of changing irrigation and planting dates in future climates were assessed, as well as the impacts of CO₂ fertilisation.

Results and Discussion

Model evaluation showed good model skill in the UK and Colombia ($r = 0.67$ ($p < 0.001$) in UK, $r = 0.47$ on average across Colombian regions). Initial Colombian GLAM results suggest a decrease in yields by 2050 (Figure 1). This is primarily due to increases in temperature which shorten crop durations for some of the colder regions, leading to lower yields. For some hotter regions increased temperatures led to crop failure.

Preliminary SimCast runs show that with 2°C warming, late blight risk increases particularly strongly in areas where most potatoes are currently grown (Figure 2). Potential yield losses from blight can be greater than 30 % (e.g. Dowley et al., 2008). The projected increases in blight risk in some areas of greater than 25 % could therefore result in substantial yield losses without protective measures, comparable to those that result from the abiotic stresses associated with climate change as seen in Figure 1.

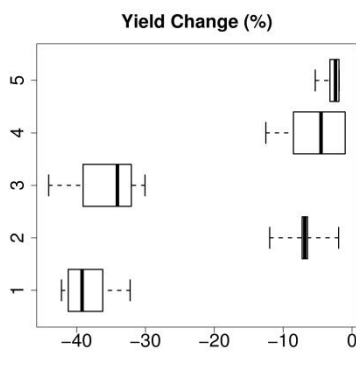

Figure 1. Simulated yield change in 5 Colombian regions by 2050 using RCP8.5. Uncertainty shown across 5 GCMs.

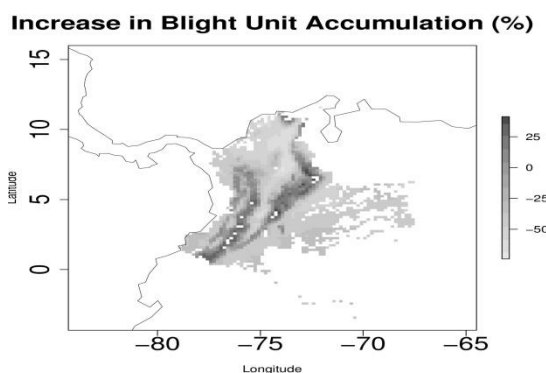

Figure 2. Blight unit percentage increase with 2°C warming across Colombian potato growing areas.

Conclusions

These initial results suggest that potato abiotic stresses will increase with climate change in the majority of regions in Colombia, with biotic stresses showing more regional variation. This will necessitate a combination of changes to potato agriculture to combat these impacts, such as the shifting of potato growing areas, planting dates and cultivars to help alleviate the most significant impacts of stresses. This work will be used as a framework for global modelling of abiotic and biotic impacts on potato agriculture, using country-level yield data to estimate global impacts.

References

- Challinor, A., J. Wheeler, T., R. Craufurd, P., Q. Slingo, J., M. Grimes, D., I., F. (2004), Design and optimisation of a large-area process-based model for annual crops, *Agricultural and Forest Meteorology*, 124:99-120.
- Dowley, L.J. Grant, J. Griffin, D., (2008) Yield losses caused by late blight (*Phytophthora infestans* (Mont.) de Bary) in potato crops in Ireland, *Irish Journal of Agricultural and Food Research*, 47:69-78.
- Oerke, E., C. (2006), Crop losses to pests, *The Journal of Agricultural Science*, 144:3143.
- Portmann, F. T., Siebert, S. Döll, P. (2010), MIRCA2000 – Global monthly irrigated and rainfed crop areas around the year 2000: A new high-resolution data set for agricultural and hydrological modeling, *Global Biogeochemical Cycles*, 24.
- Rivington, M. Koo, J., (2011), Report on the Meta-Analysis of Crop Modelling for Climate Change and Food Security Survey, 4:77-80.
- Sparks, A.H. Forbes, G.A. Hijmans, R.J. Garrett, K. A. (2011), A metamodeling framework for extending the application domain of process-based ecological models, *Ecological Society of America*, 2(8).
- Taylor K.E., Stouffer R.J., Meehl G.A., (2012), An overview of CMIP5 and the experiment design, *Bulletin of the American Meteorological Society*, 93(4):485-498.

Climate change and dryland wheat systems in the US Pacific Northwest

*T. Karimi*¹ – *C. O. Stöckle*¹ – *D. Huggins*² – *R. Nelson*¹

¹ Department of Biological Systems Engineering, Washington State University Pullman, Washington, USA

² USDA Agricultural Research Service, Pullman, Washington, USA

Introduction

The wheat-based dryland cropping systems of the US Pacific Northwest (PNW) are productive and practiced across a large precipitation range (180 – 700 mm) defining three levels of cropping intensification: annual cropping (High), crop-crop-fallow (Intermediate), and crop-fallow (Low). There is interest to assess how climate change will impact these traditional systems and what avenues are available for adaptation. By the end of the century, precipitation in the PNW is projected to change by -1.8 to 12.5 % while mean temperature will increase 1.7 to 6.5 °C. Concurrently, atmospheric carbon dioxide concentration will increase from today's average of ~400 ppm to 538 ppm to 936 ppm depending on future emissions of greenhouse gases. We have conducted a computer simulation-based regional study to contribute some answers to possible futures of wheat systems in the region.

Materials and Methods

Climate change impact simulations were performed using CropSyst (Stöckle et al., 2003). Gridded (4x4 km) daily weather projections were obtained from 14 GCMs for the period 2010-2100, including two CO₂ representative concentration pathways (RCP 4.5 and 8.5). Historical weather on the same grid for the period 1979-2010 was used as baseline. The STATSGO data base provided soil characterization, and 5 years of satellite-based crop data layers allowed identification of crop lands and cropping intensity within each grid cell. A typical rotation was selected for each cropping intensity area, and conventional and reduced tillage management were considered.

Results and Discussion

Overall, climate change is projected to have a positive impact with yields increasing by 10 to over 40 % on average, with significant variation throughout the region. As an example, table 1 shows historical average yields (kg/ha) and the average ratio (R) of future (both RCPs) to baseline yields for winter wheat in the high, intermediate and low cropping intensity areas, presented for the 2030s (2015-2045), 2050s (2035-2065), and 2070s (2055-2085) time periods and under conventional tillage management. Figure 1 shows that the intermediate cropping intensity area (shown for RCP8.5 and the 2070s period, and as average of all GCMs) will tend to decrease with gains in low and high cropping intensity areas. Analyzing these projections considering year-to-year weather variability and the uncertainty provided by the different projections of the 14 GCMs gives a richer picture of future outcomes (data not shown).

Table 1. Historical yields and ratio of future to baseline winter wheat yields for the high, intermediate and low cropping intensity area

Cropping System	RCP	R			Yield (kg/ha)
		2030s	2050s	2070s	Historical
High	4.5	1.17	1.26	1.32	5000
	8.5	1.13	1.25	1.29	
Intermediate	4.5	1.13	1.22	1.27	4760
	8.5	1.08	1.21	1.25	
Low	4.5	1.11	1.24	1.31	2574
	8.5	1.02	1.24	1.43	

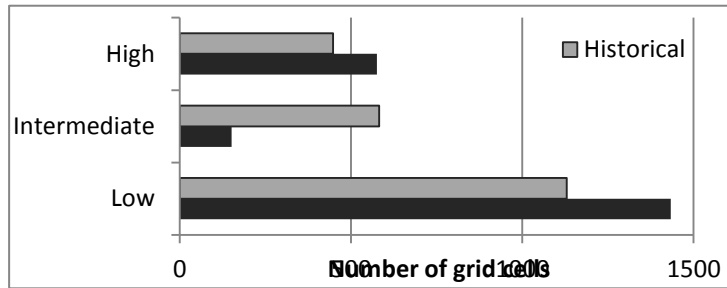

Figure 1. Change of cropping intensity area for the 2070s period and RCP 8.5.

Conclusions

With adequate adaptation of management, the productivity of dryland wheat-based systems in the PNW is likely, on average, to experience gains. These gains will not be uniform across the landscape and some of the intermediate area may become more suitable to lesser or higher degree of cropping intensification. To place this study in context, it must be recognized that large uncertainty exists about the frequency and severity of future extreme events, and about climate change effects on pests, diseases and weeds that could impact wheat production and cost.

Acknowledgements

This study was supported by the United States Department of Agriculture NIFA (grant no: BJKL03SB002. Approaches to climate change for inland Pacific Northwest agriculture).

References

Stöckle, C.O., Donatelli, M., Nelson, R. (2003). CropSyst, a cropping systems simulation model. *Eur. J. Agron.* 18, 289–307.

Intercomparison of timothy models in northern countries

*P. Korhonen*¹ – *T. Palosuo*¹ – *M. Höglind*² – *T. Persson*² – *M. van Oijen*³ – *G. Jégo*⁴ – *P. Virkajärvi*¹ – *G. Bélanger*⁴ – *A.-M. Gustavsson*⁵

¹ Natural Resources Institute Finland (Luke), Viikinkaari 4, 00790 Helsinki, panu.korhonen@luke.fi

² Norwegian Institute of Bioeconomy Research (NIBIO)

³ Centre for Ecology and Hydrology, UK

⁴ Agriculture and Agri-Food Canada (AAFC)

⁵ Swedish University of Agricultural Sciences (SLU)

Introduction

Livestock and dairy farming based on intensive silage production generate a major share of agricultural income in northern Europe and Canada. These intensive silage production systems require more inputs than permanent grasslands and optimization of production to be profitable. In northern regions, timothy (*Phleum pratense* L.) is one of the major grass species grown either in monocultures or as a part of grass and/or legume mixtures. This crop is usually harvested for silage 2-3 times during a growing season. Models that simulate the development of timothy swards have been developed, but the performance of different models has not been compared so far. The aim of this study was to compare the performance of timothy models for the predictions of yield using observed data comprising a wide range of the climate, cultivars, and soil and crop management practices that are associated with timothy production in its main production areas in Canada and Northern Europe.

Materials and Methods

The models chosen for the model comparison were BASGRA (Höglind et al., 2001), CATIMO (Bonesmo and Bélanger, 2002), and STICS (Jégo et al., 2013). The models simulated the dry-matter accumulation of timothy on a daily basis. The level of the process descriptions and output variables varied among the models. The study focused on the model-estimated dry matter yields of the first and second cuts.

Table 1. Locations and data used for model calibrations.

Location	Latitude/Longitude	Cultivar	Years
Maaninka, Finland	63.14N/27.32E	Tammisto	2006-2007
Rovaniemi, Finland	66.35N/26.01E	Iki	1999-2001
Saerheim, Norway	58.36N/5.39E	Grindstad	2000-2002
Quebec, Canada	46.47N/71.07W	Champ	1999-2001
Lacombe, Canada	52.28N/113.44W	Climax	2004-2005
Fredericton, Canada	45.55N/66.32W	Champ	1991-1993
Umeå, Sweden	63.45N/20.17E	Jonatan	1995-1996

Detailed calibration of the models was done with observed data from 7 sites located in Finland, Norway, Sweden, and Canada (Table 1). The performances of models were compared with cultivar-specific and non-cultivar-specific (global) calibrations. The

method used provides information about the robustness of model estimates and their sensitivities to cultivar-specific parameterisation. The results also show the magnitude of uncertainties related to simulations done with detailed calibrations.

Results and Discussion

A comparison of model-estimated yields of the first and second cuts showed that models were sensitive to the two calibration methods. An example of preliminary results shows how the simulation results can differ when different calibration methods are used (Fig. 1).



Figure 1. An example with the BASGRA model at one site of differences in simulated dry matter (DM) yield between two calibration methods: cultivar-specific and non-cultivar-specific (global)

Conclusions

The results of this study showed the strengths and weaknesses of different modelling approaches for yield estimates of forage grasses. Model estimates were sensitive to datasets applied in calibrations. The performance of the models for simulating the nutritive value of forage grasses remains an important aspect to be compared in future.

Acknowledgements

This research is conducted in the context of FACCE MACSUR knowledge hub. PK and TP were supported by the NORFASYS project (decision no. 268277) funded by the Academy of Finland.

References

- Bonesmo, H. and G. Bélanger. (2002). Timothy yield and nutritive value by the CATIMO Model : I . Growth and nitrogen. *Agronomy Journal*, 94, 337–345.
- Höglind, M., A. H. C. M. Schapendonk, M. Van Oijen. (2001). Timothy growth in Scandinavia: combining quantitative information and simulation modelling. *New Phytologist*, 151, 355–367.
- Jégo, G., G. Bélanger, G. F. Tremblay, Q. Jing, V. S. Baron. (2013). Calibration and performance evaluation of the STICS crop model for simulating timothy growth and nutritive value. *Field Crops Research*, 151, 65 - 77.
- Van Oijen, M., M. Höglind, H. M. Hanslin, N. Caldwell. (2005). Process-Based Modeling of Timothy Regrowth. *Agronomy Journal*, 97, 1295-1303.

Impacts of soil and weather data aggregation in spatial modelling of net primary production of croplands

M. Kuhnert^{1*} – *J. Yeluripati*^{1,12} – *P. Smith*¹ – *H. Hoffmann*² – *J. Constantin*³ – *E. Coucheny*⁴ – *R. Dechow*⁵ – *H. Eckersten*⁶ – *T. Gaiser*² – *B. Grosz*⁵ – *E. Haas*⁷ – *K. C. Kersebaum*⁸ – *R. Kiese*⁷ – *S. Klatt*⁷ – *E. Lewant*⁴ – *C. Nendel*⁸ – *H. Raynal*³ – *C. Sosa*⁴ – *X. Specka*⁸ – *E. Teixeira*⁹ – *E. Wang*¹⁰ – *L. Weihermüller*¹¹ – *G. Zhao*² – *Z. Zhao*¹⁰ – *F. Ewert*²

¹ Institute of Biological and Environmental Sciences, School of Biological Sciences, University of Aberdeen, 23 St Machar Drive, Aberdeen AB24 3 UU, Scotland, UK

² Crop Science Group, INRES, University of Bonn, Katzenburgweg 5, 53115 Bonn, DE

³ INRA, UMR 1248 AGIR & UR0875 MIA-T, F-31326 Castanet-Tolosan, FR

⁴ Biogeophysics and water quality, Department of Soil and Environment, Swedish University of Agricultural Sciences, Lennart Hjelm's väg 9, 750 07 Uppsala, SE

⁵ Thünen-Institute of Climate-Smart-Agriculture, Bundesallee 50, 38116 Braunschweig, DE

⁶ Department of Crop Production Ecology, Swedish University of Agricultural Sciences, Ulls väg 16, 750 07 Uppsala, SE

⁷ Institute of Meteorology and Climate Research – Atmospheric Environmental Research, Karlsruhe Institute of Technology, Kreuzackbahnstraße 19, 82467 Garmisch-Partenkirchen, DE

⁸ Institute of Landscape Systems Analysis, Leibniz Centre for Agricultural Landscape Research, 15374 Müncheberg, DE

⁹ Systems Modelling Team (Sustainable Production Group), The New Zealand Institute for Plant and Food Research Limited, Canterbury Agriculture & Science Centre, Gerald St, Lincoln 7608, NZ

¹⁰ CSIRO Land and Water, Clunies Ross Street, Canberra, ACT, AU

¹¹ Institute of Bio- & Geosciences Agrosphere (IBG-3), Forschungszentrum Jülich, 52425 Jülich, DE

¹² The James Hutton Institute, Craigbuckler, Aberdeen, AB15 8 QH, UK

* matthias.kuhnert@abdn.ac.uk

Introduction

Spatial modelling of net primary production (NPP) enables extrapolation of observations or predictions for future developments of ecosystems. Required input data, e.g. variables describing soil and weather, are often derived from different scales, which may affect simulation results. Literature is lacking on studies addressing the quantification of aggregation effect on NPP modelling. Thus, the objective of this study is to calculate differences between simulation results of five resolutions ranging from 1 to 100 km.

Materials and Methods

In a multi-model approach NPP is simulated by nine models for the German state North Rhine-Westphalia. The simulations consider croplands assuming wheat and maize monocultures with constant management.

Weather and soil input data are aggregated for five grid maps of 1, 10, 25, 50 and 100 km resolution, with the coarser resolutions based on data aggregation of the 1 km grid map. While the weather data are averaged for the coarser resolutions, the soil data are represented by the dominant soil type.

The impact of data aggregation on NPP is named the aggregation effect ($E_{aggregation}$) and represents the maximum difference between NPP averages for the five resolutions divided by mean NPP at 1km resolution:

$$E_{aggregation} = \frac{\max(NPP_{Res1}, \dots, NPP_{Res100}) - \min(NPP_{Res1}, \dots, NPP_{Res100})}{NPP_{Res1}}$$

Results and Discussion

The aggregation of both input data sets at the same time shows the lowest NPP average for the 100 km resolution, without a clear trend across the scales. For most models $E_{aggregation}$ is lowest for the climate aggregation and highest, if both input data sets are aggregated (Fig. 1). However, since the two aggregation approaches for soil and weather data are different and not comparable, it is not possible to detect the more divers parameter set. As both approaches represent the standard techniques for data aggregation, the aggregation of the climate shows a minor impact on the simulated NPP values in comparison to soil data aggregation. The aggregation of both, weather and soil data, cause an aggregation effect of 1 – 13 % depending on the model, with the strongest impact for the step from 50 to 100 km.

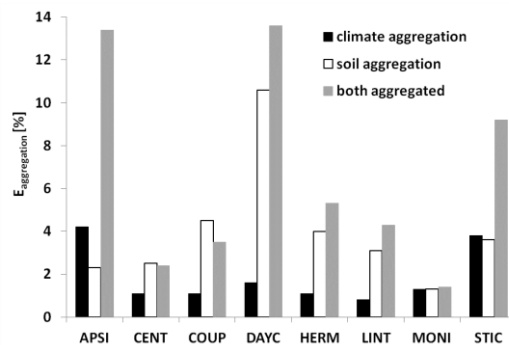

Figure 1. E_{aggregation} for only climate data aggregation, only soil aggregation and both data sets aggregated.

Conclusions

Data aggregation leads to changes in NPP estimation of up to 13 % compared to the 1 km resolution with the strongest impacts for the 100 km resolution. Using the standard techniques for up-scaling, weather data aggregation shows a lower impact on simulated NPP than the aggregation of the soil data.

Acknowledgements

This work was financially supported by the German Federal Ministry of Food and Agriculture (BMEL) through the Federal Office for Agriculture and Food (BLE), grant number 2851ERA01J, project MACSUR.

Introducing the genetic variability in crop models by combining phenotyping with modelling

S. Lacube^a – *B. Parent*^a – *G. Hammer*^b – *F. Tardieu*^a

^a INRA, UMR 759, LEPSE 2 Place Pierre Viala, Montpellier 34060, France

^b Queensland Alliance for Agriculture and Food Innovation, University of Queensland, Brisbane, QLD 4072

Linking crop models with genetic analyses potentially allow prediction of the comparative advantages of genotypes under environmental scenarios with water or temperature stresses (Parent & Tardieu, 2014, Technow et al., 2015). Hence, we are working on the integration of genotype-dependent parameters measured in a phenotyping platform in a crop model. The first step, presented here, involves the adaptation of the existing module of leaf development to incorporate genotypic variability in its formalisms and parameters.

We have worked on an existing leaf expansion model developed in APSIM, which applied to virtual genotypes differing only on maximum leaf growth rate and its sensitivity to soil water deficit and vapour pressure deficit (Chenu et al., 2008, 2009). We have extended it to represent real genotypes differing in maximum number of leaves, timing of leaf initiation, appearance and duration of leaf expansion, shape of leaves (length vs. width) and sensitivity to water deficit and evaporative demand. First, parameters have been extracted from platform raw data. For example:

The phyllochron was estimated in 250 genotypes in the platform. It was highly heritable in a series of experiments (Fig. 1A, E. Millet and C. Welcker) and very close to those measured in the field in few genotypes.

Parameters representing the timings of development of every leaf have been considered as dependent on final leaf number only. They have been estimated in a series of hybrids and considered as valid for any genotype with the same leaf number.

Parameters describing the sensitivity of leaf growth to water deficit (Fig 1B, S. Alvarez Prado) and evaporative demand were extracted from platform experiments.

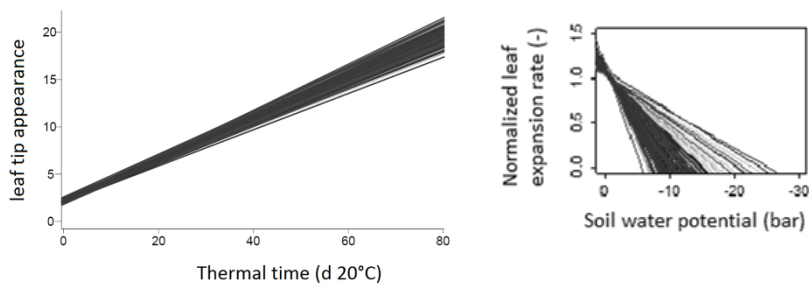

Figure 1. A. Range of variation of the phyllochron. B. Range of variation of sensitivity of leaf expansion to water deficit. Both for 250 genotypes measured in the PhenoArch Platform (INRA-LEPSE).

We paid special attention to minimize the number of parameters in formalisms with only easily measurable parameters (for leaf/plant development, leaf growth, and leaf architecture). The resulting model uses four genotypic parameters to simulate leaf development, namely: final leaf number, phyllochron, the slope of the progression of leaf ligulation with thermal time and thermal time at emergence. This is in addition to (i) maximum leaf elongation rate (assumed to vary between successive leaves in a way that only depends on final leaf number), (ii) sensitivities to evaporative demand and soil water potential, assumed to be common to all leaves, (iii) leaf width and its relationship with light.

We are currently testing the adapted model in relation with a network of 30 experiments in the field to investigate its capacity of simulating genotype by environment interaction.

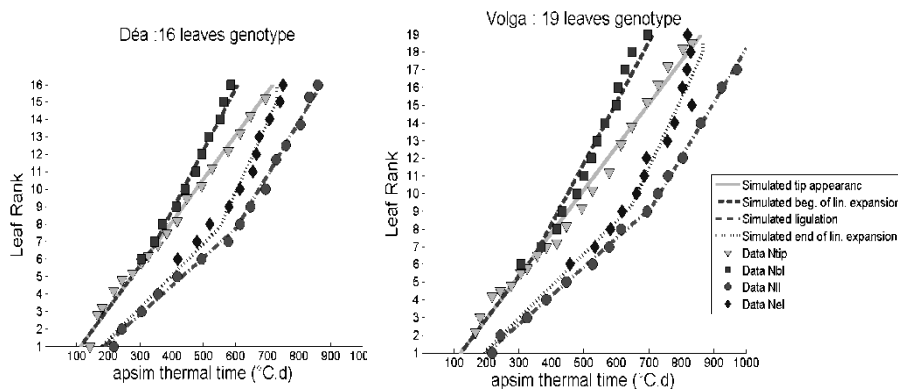

Figure 2. Simulated and measured data for 16 and 19 leaves genotypes for leaf appearance, beginning of linear elongation, end of linear elongation and ligulation.

Conclusion

This work is a "proof of concept" showing that it is feasible to incorporate the genetic variability of hundred of genotypes in a crop model *via* vectors of measured parameters. In the long term, genomic prediction will allow estimations of genotypic parameters of crop models (Technow et al 2015). Combined with multi-environment simulations, this can help defining the suitability of any genotype, traits or allele in a large range of environmental scenarios.

Acknowledgements

This work was supported by the EU project FP7-244374 (Drought tolerant Yielding plants: DROPS), and the PIA-ANR project Amaizing ANR-10-BTBR-01

References

- Chenu, K., SC. Chapman, GL. Hammer et al., (2008). *Plant, Cell and Environment*, 31: 378-391
- Chenu, K., SC. Chapman, F. Tardieu et al., (2009). *Genetics*, 183 : 1507-1523
- Parent, B. and F. Tardieu (2014). *Journal of experimental Botany*, 65: 6179-6189
- Technow F, Messina CD, Totir LR, Cooper M (2015) *Plos One*, 10

Towards systematic evaluation of crop model outputs for global landuse-use models

D. Leclère – L. B. Azevedo – R. Skalský– J. Balkovič– P. Havlík

Ecosystem Services Management, IIASA, Laxenburg (Austria), leclere@iiasa.ac.at

Introduction

Land provides vital socioeconomic resources to the society, however at the cost of large environmental degradations. Global integrated models combining crop and economical models are increasingly being used to inform sustainable land use. However, little effort has yet been done to evaluate and compare these crop model output' accuracy (Mueller and Robertson, 2014). We here present a novel dataset (the *Hypercube*) generated by the EPIC crop model and used to inform the GLOBIOM land use model. We present links between the two models, before defining the rationale for evaluating the data, and illustrating it with preliminary results.

Materials and Methods

The Hypercube data. Global land surface is split into 212707 spatial units homogeneous with respect to EPIC soil, altitude and slope inputs (Skalský et al., 2008), common to GLOBIOM delineation of land cover. We simulate for 16 major crops the yield, nutrient and water inputs with the EPIC model (v. 0810) for a combination of 5 maximum N-application rates x 3 maximum water input rate, over 30 years with the AgMERRA climate data (1980-2010), with a 20 years spin-up. Other management inputs are determined similarly to (Balkovič et al., 2014).

Link between the EPIC and GLOBIOM models. The Hypercube data is overlaid with the SPAM geographical distribution of crop x management intensity to initialize management information (Skalský et al., 2008). Additional harmonization step scales SPAM & EPIC information to fit FAO area and production estimates at regional scale.

Preliminary results and Discussion

Identified evaluation criteria. The coupling modalities necessitates the *Hypercube* to adequately represent sub-national heterogeneities i) in space for one crop, ii) across crops, and ii) across management systems. Besides, the sensitivity of these performances to harmonization steps and use of SPAM data needs to be evaluated.

Table 1. Comparison of preliminary (Hypercube x land-use) data to FAO yield estimate at the scale of 30 GLOBIOM regions, using two versions of SPAM (v-beta - v0 -, and v-3.0.6 - v3 -).

Crop	Corn		Barley		Rice		Wheat		Millet	
	v0	v3	v0	v3	v0	v3	v0	v3	v0	v3
SPAM v.										
RMSE	2.62	2.53	1.08	1.15	2.79	2.89	1.46	1.51	0.97	0.83
NSE	-0.02	0.03	0.18	0.13	-0.22	-0.35	-0.02	-0.01	0.00	0.04
sppear cor.	0.45	0.44	0.66	0.68	0.15	0.47	0.59	0.58	0.19	0.3

Illustrative preliminary results. Once the Hypercube data overlaid with the year 2000 distribution of crops and management, we evaluate the fit to FAO yield estimates at the scale of the 30 GLOBIOM regions, before harmonization (Table 1). Performances vary by crop, and the influence of SPAM layer used is limited. Once harmonized at regional level, Figure 1 shows for the USA there can be differences in spatial patterns compared to the M3 data (Monfreda et al., 2008).

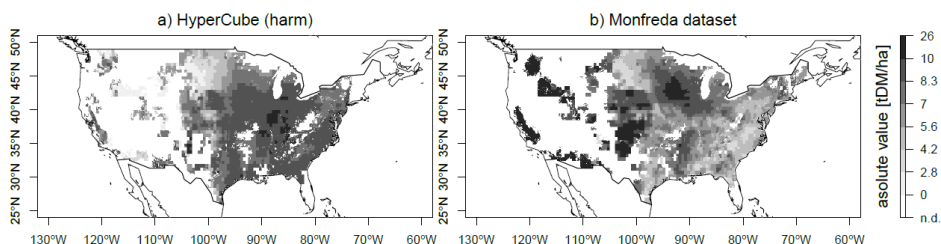

Figure 1. High-resolution comparison of maize yield between a) preliminary (Hypercube) data combined with SPAM data and harmonized to FAO data and b) the M3 dataset.

Discussion and further steps. Preliminary results will be extended to global scale for all 16 crops to propose an overall evaluation, and include a comparison of present yield gaps and main limitations to M3 dataset (Mueller et al., 2012). As reliable data on such issues is available only at very local scale, such an exercise should be viewed as an effort to develop assessments of global datasets oriented towards use in global economic models, and complementary to field-scale crop model evaluation.

Conclusions

The agricultural research community lacks thorough evaluation of emerging global high-resolution datasets of land use. We present an effort in that direction, illustrated with preliminary results from a novel set of global EPIC crop model simulations. Such an effort will help to direct efforts at improving the EPIC simulations, while allowing a better understanding of the consequences of its accuracy for its use in the GLOBIOM economic land-use model. Community-wide evaluation efforts are expected to reduce uncertainties within and across land use models.

Acknowledgements

We acknowledge funding from the SIGMA FP7 project (Grant #603719), the SUSFAN H2020 project (Grant #633692) and the European Research Council Synergy grant IMBALANCE-P (ERC-2013-SynG-610028).

References

- Balkovič, J., M., van der Velde, Skalský, R. et al., (2014). *Global Planetary Change*: 122, 107–121.
- Monfreda, C., N., Ramankutty and J.A., Foley (2008), *Global Biogeochemical Cycles*, 22: 1–19.
- Mueller, C. and R.D., Robertson (2014). *Agricultural Economics*, 45: 37–50.
- Mueller, N.D., J.S., Gerber, M., Johnston, et al., (2012), *Nature*, 490: 254–7.
- Skalský, R., Tarasovičová, Z., Balkovič, J., et al., (2008). *GEO-BENE global database for bio-physical modeling v. 1.0 (Concepts, methodology and data)*. Laxenburg, Austria.

Improving rice models for more reliable prediction of responses of rice yield to CO₂ and temperature elevation

T. Li^{1,†} – *X. Yin*^{2,‡,*} – *T. Hasegawa*^{3,‡,*} – *K. Boote*^{4,‡} – *Y. Zhu*^{5,‡} – *M. Adam*^{6,21,22} – *J. Baker*⁷ – *B. Bouman*¹ – *S. Bregaglio*⁸ – *S. Buis*⁹ – *R. Confalonieri*⁸ – *J. Fugice*¹⁰ – *T. Fumoto*² – *D. Gaydon*¹¹ – *S. N. Kumar*¹² – *T. Lafarge*⁶ – *M. Marcaida*¹ – *Y. Masutomi*¹³ – *H. Nakagawa*¹⁴ – *D. N. L. Pequeno*⁴ – *A. C. Ruane*¹⁵ – *F. Ruget*⁹ – *U. Singh*¹⁰ – *L. Tang*⁷ – *F. Tao*¹⁶ – *D. Wallach*¹⁷ – *L. T. Wilson*¹⁸ – *Y. Yang*¹⁸ – *H. Yoshida*¹⁴ – *Z. Zhang*¹⁹ – *J. Zhu*²⁰

¹International Rice Research Institute, Los Baños, Philippines; ²Centre for Crop Systems Analysis, Wageningen University, the Netherlands; ³National Institute for Agro-Environmental Sciences, Japan; ⁴University of Florida, Gainesville, Florida, USA; ⁵National Engineering and Technology Center for Information Agriculture, Jiangsu Collaborative Innovation Center for Modern Crop Production, Nanjing Agricultural University, China; ⁶CIRAD, UMR AGAP, F-34398 Montpellier, France; ⁷United States Department of Agriculture, Agricultural Research Service, Big Spring, Texas, USA; ⁸University of Milan, Cassandra lab, Italy; ⁹INRA, UMR1114 EM-MAH, F-84914 Avignon, France; ¹⁰International Fertilizer Development Center, Muscle Shoals, Alabama, USA; ¹¹CSIRO Agriculture Flagship, Brisbane, Australia; ¹²Indian Agricultural Research Institute, New Delhi, 110012, India; ¹³Ibaraki University, College of Agriculture, Ibaraki-ken, Japan; ¹⁴National Agriculture and Food Research Organization, Japan; ¹⁵NASA Goddard Institute for Space Studies, New York, USA; ¹⁶Chinese Academy of Sciences, Institute of Geographical Sciences and Natural Resources Research, China; ¹⁷INRA, UMR1248 Agrosystèmes et Développement Territorial, F-31 326 Castanet-Tolosan, France; ¹⁸Texas A&M AgriLife Research & Extension Center at Beaumont, Beaumont, Texas, USA; ¹⁹State Key Laboratory of Earth Surface Processes and Resource Ecology, Beijing Normal University, Beijing 100875, China; ²⁰State Key Laboratory of Soil and Sustainable Agriculture, Institute of Soil Sciences, Chinese Academy of Sciences, Nanjing 210008, China; ²¹CIRAD, UMR AGAP, INERA/PV, BP171, Bobo Dioulasso, Burkina Faso; ²²ICRISAT-WCA, Resilient Dryland Systems, BP 320, Bamako, Mali

* Corresponding Author, E-mail: Xinyou.Yin@wur.nl & thase@affrc.go.jp

† The leader of AgMIP Rice Team.

‡ Members of leading group of AgMIP Rice Team.

Introduction

Increased CO₂ concentration and air temperature are two very important variables associated with global warming and climate change. Assessing the putative impacts of these factors on rice production is crucial for global food security due to rice being the staple food for more than half of the world population. Rice crop models are useful for predicting rice productivity under climate change. However, model predictions have uncertainties arisen due to the inaccurate inputs and the varying capabilities of models to capture yield performance. A series of modeling activities were implemented by the AgMIP Rice Team (consisting of 16 rice models currently) to improve the model capability for reducing the uncertainties of model prediction.

Materials and Methods

The simulation exercise and model improvement were implemented in phase-wise. In the first modelling activities, the model sensitivities were evaluated to given CO₂ concentrations varying from 360 to 720 μmol mol⁻¹ at an interval of 90 μmol mol⁻¹ and air temperature increments of 0, 3, 6 and 9 °C (Li et al., 2015). In the second phase, in order to improve model response to CO₂ elevation, rice models were tested against

Free-Air CO₂ Enrichment (FACE) measurements and individual model groups conducted essential modifications on the quantification of model response. The models were firstly calibrated with the data under ambient CO₂ concentration and were then tested against the evaluated CO₂ FACE data. Further simulation exercises and model modifications were undertaken to improve response to CO₂ and temperature elevation using data from chamber experiments.

Results and Discussion

The quantified enhancement of rice grain yield varied from 2 % to 38 % when the CO₂ increased from 360 to 540 $\mu\text{mol mol}^{-1}$, and 4 to 68 % if it was doubled from 360 to 720 $\mu\text{mol mol}^{-1}$. Model predictions of grain yield changes significantly varied from +68 % to -75 % with 3 °C temperature increase, and from +30 % to -98 % with 6 °C increase, although the averages of all model predictions showed a 20 % and 40 % decreases with 3 and 6 °C increase which is close to literature reports. The large variations among models are due to fundamental differences in model algorithms that describe CO₂ fertilization and temperature effects on plant development, biomass accumulation and yield formation (Confalonieri et al., 2016, under review).

Models differed in simulated yield enhancement ranging from 1 % to 19 % with ~200 $\mu\text{mol mol}^{-1}$ CO₂ elevation after models were calibrated to ambient CO₂ condition in FACE experiments. Calibration reduced model-to-model variation, and the average grain yield enhancement over all model estimations agreed with field measurements from FACE experiments conducted at two field sites.

The results of simulation exercises with chamber experiments show the models captured the CO₂ fertilization and temperature effects on above-ground biomass with low variation among models, but less agreement among models on predicted CO₂ effects on grain yield. Many models overestimated the grain yield gains per unit CO₂ elevation on higher CO₂ conditions. Most models also underestimated the grain yield decline due to increased air temperature, which indicates a need to improve model functions related to grain-set and grain growth at elevated temperatures.

References

- Confalonieri, R., S. Bregaglio, M. Adam, F. Ruget, T. Li, T. Hasegawa, X. Yin, Y. Zhu, K. Boote, S. Buis, T. Fumoto, D. Gaydon, M. Marcaida III, H. Nakagawa, P. Oriol, A.C. Ruane, B. Singh, U. Singh, L. Tang, F. Tao, J. Fugice, H. Yoshida, Z. Zhang, L.T. Wilson, J. Baker, Y. Yang, Y. Masutomi, D. Wallach, B. Bouman (2015) A taxonomy-based approach to shed light on the babel of mathematical analogies for rice simulation. Submitted to *Environmental Modelling & Software*.
- Li T., T. Hasegawa, X. Yin, Y. Zhu, K. Boote, M. Adam, S. Bregaglio, S. Buis, R. Confalonieri, T. Fumoto, D. Gaydon, M. Marcaida III, H. Nakagawa, P. Oriol, A.C. Ruane, F. Ruget, B. Singh, U. Singh, L. Tang, F. Tao, P. Wilkens, H. Yoshida, Z. Zhang, B. Bouman (2015) Uncertainties in predicting rice yield by current crop models under a wide range of climatic conditions. *Global Change Biology* 21: 1328-1341.

Testing and improving the responses of wheat models to heat stress at anthesis and grain filling

B. Liu¹ – S. Asseng² – L. Liu¹ – L. Tang¹ – W. Cao¹ – Y. Zhu^{1,*}

¹ National Engineering and Technology Center for Information Agriculture, Jiangsu Key Laboratory for Information Agriculture, Jiangsu Collaborative Innovation Center for Modern Crop Production, College of Agriculture, Nanjing Agricultural University, China, e-mail: yanzhu@njau.edu.cn

² Department of Agricultural and Biological Engineering, University of Florida, USA

Introduction

Higher temperatures caused by future climate change will bring more frequent heat stress events and pose an increasing risk to global wheat production. Crop models are powerful tools for assessing the impact of climate change on crop yields (White *et al.*, 2011). Recently, 30 wheat models evaluated under a wide range of temperature conditions were found less accurate at higher temperatures (Asseng *et al.*, 2015). No study so far has been testing crop model responses with short-time measured heat stress data. In this study, we conducted detailed experiments to test and improve the responses of wheat models to heat stress at anthesis and grain filling.

Materials and Methods

Detailed observed data from four years environment-controlled phytotron experiments and multi-year field experiments across the main wheat production region were used to evaluate the performance of crop models in simulating heat stress effects on wheat growth and yields. We tested: (1) the performances of four widely used temperature response routines from four wheat models (APSIM-Wheat, CERES-Wheat, GECROS, and WheatGrow) with heat stress effects on post-heading durations, (2) a senescence acceleration function (HTE) to quantify high temperature effect on post-heading duration under heat stress, and (3) the responses of four wheat models (CERES-Wheat, Nwheat, APSIM-Wheat, and WheatGrow) in simulating post-heading heat stress effects on wheat growth, grain yield, and grain quality.

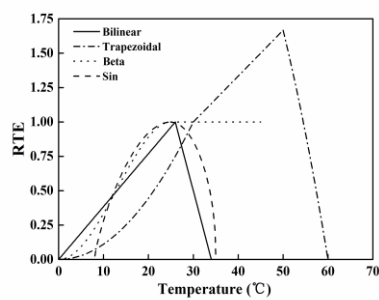

Figure 1. Temperature response of relative thermal effects (RTE) in the four temperature response routines.

Results and Discussion

Bilinear, Sin, and Beta routine could not predict post-heading durations under heat stress, while a Trapezoidal routine tended to overestimate high temperature impacts. The extension of a senescence acceleration function (HTE) significantly improved the simulations of post-heading durations under heat stress in the three routines, regardless of the original temperature routine.

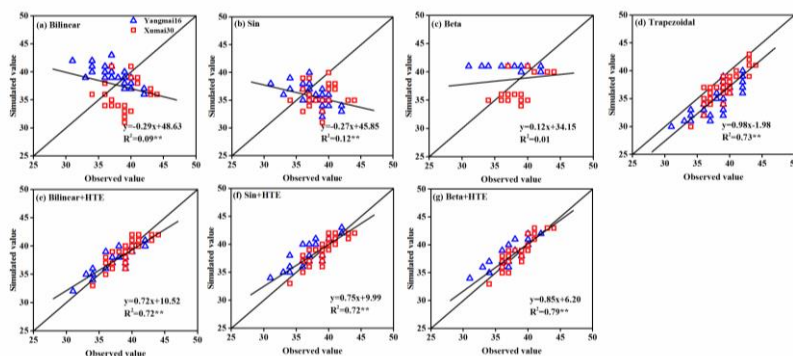

Figure 2. Comparison of observed and simulated post-heading durations (days) with seven temperature response routines for two cultivars in environment-controlled phytotron experiments.

The four tested models could reproduce some of the observed reductions in grain filling duration, final biomass, and grain yield, as well as the observed increase in grain protein concentration due to heat stress. All four models could not simulate the effects of heat stress during anthesis, particularly the impact of heat stress on grain set.

Conclusions

The four tested models varied in their responses to heat stress. The inclusion of a senescence function improved model performance for responding to late season heat stress. Future model improvements are needed for simulating the crop response to heat stress at anthesis and in particularly of heat stress effects on grain set.

Acknowledgements

This work was supported by the National High-Tech Research and Development Program of China (2013AA100404), the National Natural Science Foundation of China (31271616), the National Research Foundation for the Doctoral Program of Higher Education of China (20120097110042), the Priority Academic Program Development of Jiangsu Higher Education Institutions (PAPD) and the China Scholarship Council.

References

- Asseng S, Ewert F, Martre P et al., (2015). *Nature Climate Change*, 5, 143–147.
 White JW, Hoogenboom G, Kimball BA, Wall GW (2011). *Field Crops Research*, 124, 357-368.

Comparison of Methods and aggregation approaches to assess temperature impacts on global wheat production

B. Liu^{1,2} – S. Asseng – C. Müller – F. Ewert – J. Elliott – D.B. Lobell – A.C. Ruane – D. Wallach – J.W. Jones – P. Martre – C. Rosenzweig – P.K. Aggarwal – P.D. Alderman – J. Anothai – B. Basso – C. Biernath – A.J. Challinor – D. Cammarano – D. Deryng – G. de Sanctis – J. Doltra – E. Fereres – C. Folberth – M. Garcia-Vila – S. Gayler – G. Hoogenboom – L.A. Hunt – R.C. Izaurralde – M. Jabloun – C.D. Jones – K. C. Kersebaum – B.A. Kimball – A.-K. Koehler – S. Naresh Kumar – C. Nendel – G. O’Leary – J.E. Olesen – M.J. Ottman – T. Palosuo – P.V.V. Prasad – E. Priesack – T.A.M. Pugh – M.P. Reynolds – E. Eyshi Rezaei – R.P. Rötter – E. Schmid – M.A. Semenov – I. Shcherbak – E. Stehfest – C. Stöckle – P. Stratonovitch – T. Streck – I. Supit – F. Tao – P. Thorburn – K. Waha – G.W. Wall – E. Wang – J.W. White – J. Wolf – Z. Zhao – Y. Zhu

¹ National Engineering and Technology Center for Information Agriculture, College of Agriculture, Nanjing Agricultural University, China, e-mail: bingliu@ufl.edu

² Agricultural & Biological Engineering Department, University of Florida, Gainesville, Florida 32611, USA,

Introduction

For developing future global food security strategies we need to quantify the impact of climate change on global food production. Recently, there have been several attempts to estimate the impact of increasing temperature, as one aspect of global climate change, on the most important food crop wheat (Asseng et al., 2015, Lobell et al., 2011, Rosenzweig et al., 2014). However, different methods and aggregations were used, but results have not yet been compared among methods which is the focus of this study.

Materials and Methods

Three main different approaches have been used to assess temperature impacts on global and regional wheat production: grid-based simulation, point-based simulation and statistical regression approaches. In the grid-based simulation approach by Rosenzweig et al., (2014), global wheat production was aggregated from simulated multi-model ensemble (7 dynamic models) median at 0.5° by 0.5° grid cells; in the point-based simulation approach by Asseng et al., (2015), global wheat production was up-scaled from simulated multi-model ensemble (30 models consisting of 29 dynamic models and 1 statistical model) median at 30 high rainfall/irrigated global wheat locations. Two statistical regression approach have been used. In the first one temperature impacts on global and regional wheat yield was estimates with statistical regression approach (Lobell et al., 2011) and in the second one a linear mixed regression using county-level yield statistics and climate records (e.g. for USA: wheat yield datasets from 1990 to 2010, from USDA, including 1174 and 262 counties in 18 major wheat production states for winter wheat and spring wheat, respectively) was used.

In order to compare these different methods, the temperature impacts on wheat production at both global scale and regional scale were quantified as yield changes of 1°C increase in global mean temperature, which means that regional temperature changes were adjusted to global temperature change with the method used by Asseng et al., (2015). The temperature yield impact assessments were compared at different scales.

Results and Discussion

Wheat yield impacts of increasing temperature were similar across the methods and aggregations at global and regional scales. For example, with 1°C increase in global mean temperature, US wheat yields declined by 5.6 % and 7.6 % with grid-based and point-based simulations, respectively. With a statistical regression after Lobell et al., (2011), yields declined by 6.2 % for the US. Using an additional regression analysis with county-level yield statistics resulted in a 6.6 % yield reductions in the US (Figure 1).

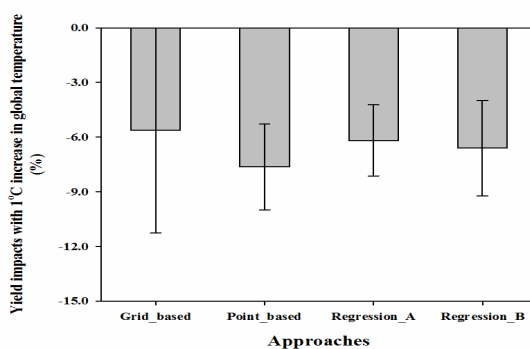

Figure 1. Estimated temperature impacts on US wheat yield with 1°C global warming using different assessment approaches. Regression_A is the statistical regression result from Lobell et al., (2011). Regression_B is a statistical regression result with county-level statistics from our own study. The error bars indicate the 95 % confidence interval.

Conclusions

Despite using very different methods and aggregation approaches, grid-based simulations, point-based simulations, and statistical regression approaches resulted in similar temperature impacts on wheat production at global (not shown here) and regional scale (shown for the US).

References

- Asseng S, Ewert F, Martre P et al., (2015). *Nature Climate Change*, 5, 143–147.
 Lobell DB, Schlenker W, Costa-Roberts J (2011). *Science*, 333, 616-620.
 Rosenzweig C, Elliott J, Deryng D et al., (2014). *Proceedings of the National Academy of Sciences*, 111, 3268-3273.

Improving CSM-IXIM maize model in DSSAT to simulate impact of elevated temperatures

*J. I. Lizaso*¹ – *L. Rodriguez*¹ – *M. Ruiz-Ramos*¹ – *C. Gabaldon-Leal*² – *J. A. Oliveira*³ –
*I. J. Lorite*²

¹ AgSystems-CEIGRAM, Technical University of Madrid, 28040 Madrid, Spain, jon.lizaso@upm.es

² IFAPA-Centro Alameda del Obispo, Junta de Andalucía, P.O. Box 3092, 14080 Córdoba, Spain

³ Technical School of Mieres, University of Oviedo, 33600 Mieres, Asturias, Spain

Introduction

Extreme weather events dramatically hurt agricultural productivity and farmers benefits. Timing of events, such as heat waves or dry spells, can disturb critical physiological processes reducing significantly the expected harvest. Boote et al., (2005) showed reduced yields caused by elevated temperatures on several annual crops associated to a decline in pollen production and viability (Boote et al., 2005; Prasad et al., 2002). Maize yield reduction in response to elevated temperatures has been associated to decreased pollen viability (Dupuis and Dumas 1990), pollen earlier desiccation (Fonseca and Westgate, 2005), disruption of the anthesis-silking synchrony and kernel abortion (Cicchino et al., 2010).

DSSAT (Decision Support System for Agrotechnology Transfer) is a suite of crop models simulating interactions among environment, genetics, and management on growth, development, and yield (Hoogenboom et al., 2010). None of the maize models in DSSAT, the traditional CERES-Maize (Jones and Kiniry, 1986) or the new and more mechanistic CSM-IXIM (Lizaso et al., 2011), explicitly considers the effects of elevated temperature on floral development, kernel set, and initial growth of grain.

We monitored the growth, development, and yield components of a short season maize hybrid, under field conditions at three contrasting thermal environments. We also examined the hybrid responses under controlled conditions, applying heat treatments at various development stages. We are currently modifying the CSM-IXIM maize model in DSSAT v4.5 to incorporate the explicit simulation of heat stress.

Materials and Methods

The maize (*Zea mays* L.) hybrid PR37N01 (FAO-300) was sown in three temperature-contrasting sites in Spain: Candás, North (43.58° N; 5.78° W; 80 m altitude), Aranjuez, Central (40.02° N; 3.6° W; 525 m), Córdoba, South (37.9° N; 4.8° W; 250 m), during 2014 and 2015. The same hybrid was grown under controlled conditions. Greenhouse day temperature was maintained around 25°C. During the 7-d heat treatments, 18 plants were moved into a hot chamber with day temperature above 35°C. At night, windows were opened in both chambers allowing temperatures inside and outside to equilibrate. Plants in the greenhouse were hand-pollinated 3-d after silking, half with pollen from the same treatment, and half with fresh pollen from a near field. Heat treatments were at V4, V9, anthesis, lag phase, early grain filling, and a non-heated

control. In 2015, an additional treatment was maintained constantly in the hot chamber. Emergence, anthesis, silking, and maturity, together with growth and yield components were monitored.

Results and Discussion

The growing season of 2014 was not especially hot in Southern Spain (S1, S2) as opposed to 2015 (processing the data). Most of the variation in measured grain yield shown in the left panel of Fig. 1 was due to changes in kernel set in apical ears (not shown). The current version of CSM-IXIM model in DSSAT v4.5 did not capture accurately the observed variation. The greenhouse experiment (Fig. 1, right panel) indicated that one week of heat stress at anthesis reduced grain yield by 65 %. The current version of the model did not simulate any major variation across treatments.

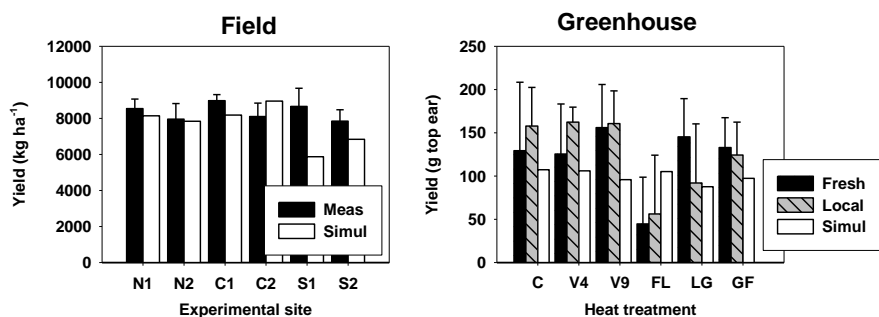

Figure 1. Left panel: Grain yield measured and simulated in two sowing dates in 2014 of field experiments in Northern (N1, N2), Central (C1, C2), and Southern Spain (S1, S2). Right panel: Grain yield in apical ears hand-pollinated with pollen from field grown plants (Fresh) or heat treated plants (Local) at V4, V9, anthesis, lag phase, early grain filling, and non-heated control. Simulations obtained with CSM-IXIM model.

Conclusions

The current CSM-IXIM maize model in DSSAT v4.5 requires incorporate the explicit simulation of heat stress. Our research group is developing these changes.

Acknowledgements

This research was funded by the project MULCLIVAR, from the Spanish Ministerio de Economía y Competitividad (MINECO) CGL2012-38923-C02-02

References

- Boote, K.J., L.H. Allen, P.V.V. Prasad et al., (2005) *J. Agric. Meteorol.* 60:469-474.
- Cicchino, M., J.I. Rattalino, M. Uribelarrea et al., (2010). *Crop Sci.* 50: 1438-1448.
- Dupuis, L. and C. Dumas (1990) *Plant Physiol* 94:665-670.
- Fonseca, A.E. and M.E. Westgate (2005). *Field Crops Res.* 94: 114-125.
- Hoogenboom G., J.W. Jones, P.W. Wilkens et al., (2010) University of Hawaii, Honolulu
- Jones C., and J. Kiniry (1986) Texas A&M University Press, College Station, TX
- Lizaso, J.I., K.J. Boote, J.W. Jones et al., (2011) *Agron J.* 103: 766-779.
- Prasad, P.V.V., K.J. Boote, L.H. Allen et al., (2002) *Global Change Biology* 8:710-721.

Model improvements reduce the uncertainty of wheat crop model ensembles under heat stress

*A. Maiorano*¹ – *P. Martre*¹ – *S. Asseng*² – *F. Ewert*³ – *C. Müller*⁴ – *R. P. Rötter*⁵ – *A. C. Ruane*⁶ – *M. A. Semenov*⁷ – *D. Wallach*⁸ – *E. Wang*⁹ – *P.D. Alderman*¹⁰ – *B. T. Kassie*² – *C. Biernath*¹¹ – *B. Basso*¹² – *D. Cammarano*¹³ – *A. J. Challinor*^{14,15} – *J. Doltra*¹⁶ – *B. Dumont*¹² – *S. Gayler*²⁴ – *K. C. Kersebaum*¹⁷ – *B.A. Kimball*¹⁸ – *A. K. Koehler*¹⁴ – *B. Liu*¹⁹ – *G. J. O’Leary*²⁰ – *J. E. Olesen*²¹ – *M. J. Ottman*²² – *E. Priesack*¹¹ – *M. P. Reynolds*²³ – *E. Eyshi Rezaei*³ – *P. Stratonovitch*⁷ – *T. Streck*²⁴ – *P. J. Thorburn*²⁵ – *K. Waha*²⁵ – *G. W. Wall*¹⁸ – *J. W. White*¹⁸ – *Z. Zhao*⁹ – *Y. Zhu*¹⁹

¹ INRA INRA, UMR759 LEPSE, 2 Place Viala, F-34 060 Montpellier, France, e-mail:

pierre.martre@supagro.inra.fr

² Agricultural and Biological Engineering Department, University of Florida, Gainesville, FL, USA

³ Institute of Crop Science and Resource Conservation (INRES), University of Bonn, Bonn, Germany

⁴ Potsdam Institute for Climate Impact Research, Potsdam, Germany

⁵ Environmental Impacts Group, Natural Resources Institute Finland (Luke), Vantaa, Finland

⁶ NASA Goddard Institute for Space Studies, New York, NY, USA

⁷ Computational and Systems Biology Department, Rothamsted Research, Harpenden, UK

⁸ INRA, UMR1248 AGIR, Castanet-Tolosan, France

⁹ CSIRO Agriculture Flagship, Black Mountain, Australia

¹⁰ Oklahoma State University, Dep. of Plant and Soil Sciences, 371 Agricultural Hall, Stillwater, OK, USA

¹¹ Institute of Biochemical Plant Pathology, Helmholtz Zentrum München, German Research Center for Environ Health, Neuherberg, Germany

¹² Department of Geological Sciences and W.K. Kellogg Biological Station, Michigan State University, MI, USA

¹³ James Hutton Institute, Invergowrie, Dundee, DD2 5DA, Scotland, UK.

¹⁴ ICAS, School of Earth and Environment, University of Leeds, Leeds, UK

¹⁵ CGIAR-ESSP Program on Climate Change, Agriculture and Food Security, CIAT, Cali, Colombia

¹⁶ Cantabrian Agricultural Research and Training Centre (CIFA), Muriedas, Spain

¹⁷ Institute of Landscape Systems Analysis, Leibniz Centre for Agricultural Landscape Research (ZALF), Müncheberg, Germany

¹⁸ USDA-ARS, US Arid-Land Agricultural Research Center, Maricopa, AZ, USA

¹⁹ College of Agriculture, Nanjing Agricultural University, Nanjing, Jiangsu, China

²⁰ Grains Innovation Park, Department of Economic Development Jobs, Transport and Resources, Horsham, Australia

²¹ Department of Agroecology, Aarhus University, Tjele, Denmark

²² The School of Plant Sciences, University of Arizona, Tucson, AZ, USA

²³ CIMMYT, D.F. Mexico, Mexico

²⁴ Institute of Soil Science and Land Evaluation, University of Hohenheim, Stuttgart, Germany

²⁵ CSIRO Agriculture Flagship, Queensland, Australia

Introduction

Wheat crop multi-model ensembles (MME) have been suggested as an effective measure to increase reliability of impact estimates (Martre et al., 2015), but they are costly to execute. Therefore, model improvements have been suggested to reduce uncertainty of climate impact assessments and reduce the number of models required for an acceptable level of simulation uncertainty (Challinor et al., 2014; Rötter et al., 2011). In this study we improved 15 wheat crop models in simulating heat stress impacts and investigated the effect on MME performances and predictive skills.

Materials and Methods

Fifteen models from the AgMIP-Wheat model ensemble (Asseng et al., 2015) were improved through re-parameterization or incorporating or modifying heat stress effects on phenology, leaf growth and senescence, biomass growth, and grain number and size. Quality-assessed data from the USDA 'Hot Serial Cereal' (HSC) experiment were used to calibrate the improved models. The CIMMYT 'International Heat Stress Genotype Experiment' (IHSGE) global experiment was used to independently evaluate the improvements. Performances and predictive skills, using a new uncertainty estimation framework (Wallach et al., unpublished), of the population of 15 unimproved and improved models were evaluated through mean squared error and its decomposition in squared bias and variance. Model improvement effects on MME and the number of models required in an ensemble were analyzed through bootstrap calculation with 1 to 15 models MME.

Results and Discussion

Improvements decreased the variation (10th to 90th ensemble percentile range) of simulated grain yields on average by 26 % in the independent evaluation dataset for crops grown in mean seasonal temperatures > 24°C. Model population grain yield mean squared error decreased by 37 % in particular for the consistent improvement of the worst skilled models. Model population prediction skills increased by 47 % due to a reduction in the model population uncertainty range by 26 %. The latter improvement was mostly due to a decrease in model variance. Considering 13.5 % coefficient of variation as a benchmark (Taylor, 2001), the number of required models for MME impact assessments was halved, from 15 to 8, with improved models.

Conclusions

We demonstrated that crop model improvements using experimental data sets can increase the simulation and predictive skills of MME and can reduce the number of models required for reliable impact assessments. Improving crop models is therefore important reducing the size of MME for practical impact assessments.

Acknowledgements

This work was supported by the AgMIP (<http://www.agmip.org/>) and MACSUR (<http://macsur.eu/>) projects. A.M. has received the support of INRA and of the EU in the framework of the Marie-Curie FP7 COFUND People Programme, through the award of an AgreeSkills fellowship under grant agreement n° PCOFUND-GA-2010-267196.

References

- Asseng, S., Ewert, F., Martre, P., et al, (2015). *Nature Climate Change* 5, 143–147
- Challinor, A., Martre, P., Asseng, S., et al., (2014). *Nature Climate Change* 4, 77–80.
- Martre, P., Wallach, D., Asseng, S., et al., (2015). *Glob. Change Biology*
- Rötter, R.P., Carter, T.R., Olesen, J.E., Porter, J.R. (2011). *Nature Climate Change* 1, 175–177
- Taylor, K.E. (2001). *Journal of Geophysical Research* 106, 7183–7192

Estimating winter wheat phenological parameters: implications for crop modeling

G. S. McMaster

USDA-ARS, Agricultural System Research Unit, Fort Collin, CO USA greg.mcmaster@ars.usda.gov

Introduction

Crop parameters, such as the timing of developmental events, are critical for accurate simulation results in crop simulation models, yet uncertainty often exists in determining the parameters. Factors contributing to the uncertainty include: a) sources of variation within a plant (i.e., within different shoots of the plant), b) spatial variation in the trait within small areas of presumably “uniform” conditions for many reasons (e.g., seed size, vigor, and planting depth; differences in microenvironment), and c) the well-recognized reality of GxExM interactions. (Note here on “management”: in most instances “M” can be viewed as altering E, and therefore won’t be mentioned again here.) The importance of these sources of variation in estimating parameters is largely dependent on the objectives of the modeling project.

Diverse approaches have been used to deal with uncertainty in parameter estimation. One common approach is to estimate the parameter from standard statistics (e.g., mean, median, variance, range), and occasionally extended to consider the distribution, with a static value used for the simulation. Experience has shown a couple of complications. The first is the existence of anomalies, or outliers, which cannot be explained by experimental error that can significantly impact the statistics or distributions. The second is that both the genotype and environment (and interaction) can influence the statistics and distributions.

While plasticity has many aspects, phenotypic plasticity describes the range of phenotypes produced by a single genotype under varying environmental conditions Bradshaw (1965). Studies have examined the heading date and yield phenotypic plasticity of 299 winter wheat (*Triticum aestivum* L.) genotypes (Grogan et al., 2016A?), and considered allelic variants known to effect flowering time in differing environments (Grogan et al., 2016B). On-going efforts are examining how environment influences phenotypic plasticity, and whether developmental parameters can be better estimated by groupings based on maturity classes, environmental classification, or other criteria.

The objectives of the presentation will be to present analyses of winter wheat phenological data for both individual genotypes and collections of genotypes grown in different environments, and provide thoughts on the implications of these analyses for crop modeling.

Materials and Methods

Results are based on many data sets collected over the past 30+ years in Colorado, with the emphasis on five primary experimental data sets. All five experiments record-

ed at least the developmental events of seedling emergence, jointing, flag leaf complete, heading, anthesis start, and physiological maturity. Additional measurements included biomass, LAI, cover, and plant height over time, yield, and yield component. Other general details of these five experiments:

- *Greeley LIRF irrigation experiment*. Three-year experiment with different irrigation treatments ranging from dryland to full irrigation, including limited irrigation applied only at specific developmental stages. Twenty-four varieties were evaluated.
- *The Triticeae Coordinated Agricultural Project* (<http://www.triticeaecap.org>). 299 hard winter wheat genotypes were evaluated in 11 environments during 2012 and 2013. More details presented in
- *Scott Field spatial landscape study*. Dryland study on a 54-ha field on a farm north-east of Fort Collins. More details can be found in McMaster et al., (2012).
- *Colorado State University Horticulture Farm study*. Pre-plant tillage and residue cover levels for 1-2 varieties over 6 years. More details presented in McMaster et al., (2002, 2013).
- *Colorado State University Variety and Irrigation study*. A 3-yr study conducted at Fort Collins and Akron examining 12 varieties response to dryland vs. fully irrigated conditions. More details presented in McMaster et al., (2003).

Acknowledgements

The data and thoughts presented in this work has been the result of work and influenced by too many scientists to mention specifically, and the author is eternally indebted to them.

References

- Bradshaw, A. (1965). Evolutionary significance of phenotypic plasticity in plants. *Advances in Genetics*, 13: 115–155.
- Grogan, S.M., J. Anderson, P.S. Baenziger, et al., (2016A?). Phenotypic plasticity of winter wheat heading date and grain yield across the U.S. Great Plains. Submitted to *Crop Science*.
- Grogan, S.M., G. Brown-Guedira, S.D. Haley, et al., (2016B?). Allelic variation in developmental genes and effects on winter wheat heading date in the U.S. Great Plains. Submitted to *PLoS One*
- McMaster, G.S., D.B. Palic, and G.H. Dunn. (2002). Soil management alters seedling emergence and subsequent autumn growth and yield in dryland winter wheat-fallow systems in the Central Great Plains on a clay loam soil. *Soil & Tillage Research*, 65:193-206.
- McMaster, G.S., J.C. Ascough II, D.C. Nielsen, P.F. Byrne, S.D. Haley, M.J. Shaffer, A.A. Andales, and G.H. Dunn. (2003). GPFARM plant model parameters: Complications of varieties and the genotype x environment interaction in wheat. *Transactions of the American Society of Agricultural Engineers*, 46(5): 1337-1346.
- McMaster, G.S., T.R. Green, R.H. Erskine, D.A. Edmunds, and J.C. Ascough II. (2012). Interrelationships between wheat phenology, thermal time, and landscape position. *Agronomy Journal*, 104:1110-1121.
- McMaster, G.S., J.C. Ascough II, D.A. Edmunds, D.C. Nielsen, P.V.V. Prasad. (2013). Simulating crop phenological responses to water stress using the PhenologyMMS software component. *Applied Engineering in Agriculture*, 29(2):233-249.

Towards workable solutions for Phenotypic Prediction within complex GxExM systems: Integrating crop growth models (CGM) with whole genome prediction (WGP)

*C. D. Messina*¹ – *F. Technow*² – *R. Totir*² – *C. Gho*³ – *M. Cooper*²

¹ Dupont Pioneer, 7200 NW 62nd Ave Johnston, Iowa, USA, charlie.messina@pioneer.com

² DuPont Pioneer, USA

³ Semillas Pioneer, Ltda. Chile

Abstract

Genotype-by-environment-by-management interactions (GxExM) are ubiquitous in crop production systems. The nature and repeatability of GxExM determine the system predictability, the expression of measurable traits and conditions the potential rate of genetic progress in crops. Crop growth and development models (CGM) organized using principles of crop physiology can be employed to understand and predict the consequence of GxExM on traits and harness this knowledge to enhance genetic improvement. Whole genome prediction enables the breeder to have a first view of many of these trait phenotypes for an individual before experimental phenotyping. But this requires phenotyping large populations utilized as training sets for traits which expression is conditional upon the state of the GxExM system. The integration of CGM with WGP can provide a path towards a workable solution for phenotyping prediction. In prior studies we introduced the linkage between CGM and WGP and demonstrated its reduction to practice. In this presentation we utilized simulation to evaluate the gains from utilizing CGM-WGP methodology relative to GBLUP to variation in the complexity of the GxExM system.

Advances in representing the role of water content in modelling nitrous oxide emissions

*H. Mielenz*¹ – *P. J. Thorburn*²

¹ CSIRO Agriculture, GPO Box 2583, Brisbane, QLD 4001, Australia, e-mail: henrike.mielenz@csiro.au

² CSIRO Ecosystem Sciences, Dutton Park, Queensland, Australia

Introduction

Understanding the processes causing nitrous oxide (N₂O) emissions is important for designing management strategies to mitigate soil N₂O emissions and help address climate change (Syakila and Kroeze, 2011). Denitrification is generally the major process responsible for N₂O emissions (Syakila and Kroeze, 2011). It occurs at high water contents. However, there is a great disparity between models on the threshold water content above which denitrification commences (Heinen, 2006). This threshold will determine the frequency of denitrification events and hence the magnitude of N₂O emissions. In some models such as DAYCENT the parameter determining this threshold is calibrated for each site, and so the model cannot be generalised. It is important to gain a better understanding of this issue. In this study, daily measurements of N₂O emissions from five field sites were used to identify a relation between the threshold parameter above which denitrification commences and a measurable soil property.

Materials and Methods

N₂O emissions and crop yields were simulated with APSIM from experiments at five field sites across the northern and southern grains regions of Australia (Mielenz et al., 2015a, 2015b). Experiments covered different soil types, crops, and the management practices of fertilisation, irrigation, and tillage. Measurements comprised crop yields, daily N₂O emissions, and soil water and mineral nitrogen contents at varying depths. The measured data were characterised by long periods of low N₂O emissions (i.e. <0.005 kg N₂O-N ha⁻¹), which we attributed to the process of nitrification. Few, relatively short periods of high N₂O emissions occurred after rainfall/irrigation and fertilisation which we attributed to denitrification. The frequency of the predicted denitrification events with the default parameterisation of the model was higher than observed. To be consistent with the measurements, the threshold soil water content (expressed as water filled pore space) above which denitrification starts (dnit_{lim}) was altered. It was changed from a constrained value (equal to the water filled pore space at drained upper limit, DUL) to a variable value that could be set for each site to match the patterns of denitrification events.

Results and Discussion

The calibration of dnit_{lim} for each site (using a subset of the treatments in the experiments) showed a direct relation to DUL across the five experimental sites (Fig. 1a): dnit_{lim} ≈ 1.1*WFPS_{DUL}. After introducing and calibrating dnit_{lim}, seasonal N₂O emissions

in 48 crop and fallow validation datasets were predicted with an $R^2 = 0.91$ (Fig. 1c). This suggests that $dnit_{lim}$ is a site-specific variable that can be predicted from DUL. Also, yields for the various crops grown in the experiments were predicted accurately (Fig. 1b).

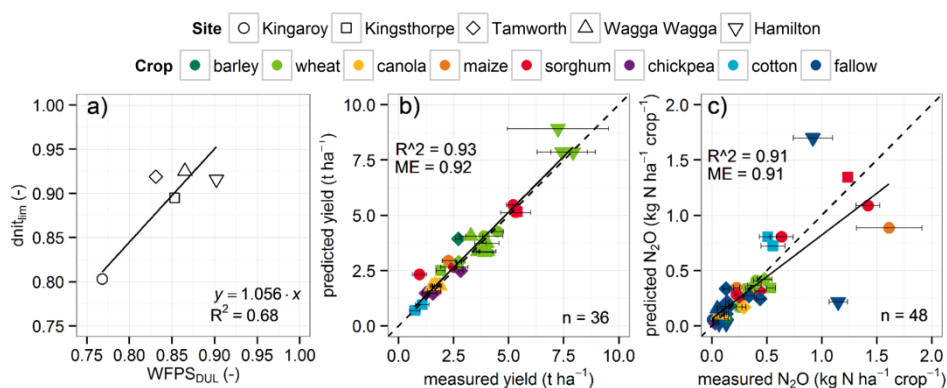

Figure 1: a) Threshold water filled pore space above which denitrification starts ($dnit_{lim}$) in relation to the water filled pore space at drained upper limit ($WFPS_{DUL}$) for the five experimental sites; b) Predicted against measured yields and c) seasonal N_2O emissions for the validation data sets from the five experimental sites. Standard deviation of the observations (horizontal bars), one-one-lines (dashed) and regression lines (solid) are shown; ME is model efficiency.

Conclusions

The advances in representing the role of water content in modelling N_2O emissions in APSIM have greatly improved prediction of N_2O emissions (Mielenz et al., 2015b). Our approach to determining the threshold water content above which denitrification commences may have applicability to other N_2O models.

Acknowledgements

This research was undertaken as part of the National Agricultural Nitrous Oxide Research Program (NANORP) funded by the Australian Grains Research and Development Corporation (GRDC) and the Australian Government Department of Agriculture. Thanks to the co-authors of the papers by Mielenz et al., (2015a, 2015b) for providing the experimental data used in this study.

References

- Heinen, M. (2006). Simplified denitrification models: Overview and properties. *Geoderma* 133, 444–463. doi:10.1016/j.geoderma.2005.06.010
- Mielenz, H., Thorburn, P., Harris, R., Officer, S., Li, G., Schwenke, G., Grace, P. (2015a). Nitrous oxide emissions from farming systems across varying environmental conditions in Australia's main grains regions. *Soil Res.* submitted.
- Mielenz, H., Thorburn, P., Scheer, C., Bell, M.J., De Antoni Migliorati, M., Grace, P.R.2(015b). Opportunities for mitigating nitrous oxide emissions in subtropical cereal and fibre cropping systems: a simulation study. *Agric. Ecosyst. Environ.* under review.
- Syakila, A., Kroeze, C. (2011). The global nitrous oxide budget revisited. *Greenh. Gas Meas. Manag.* 1, 17–26. doi:10.3763/ghgmm.2010.0007

Global gridded crop model evaluation: benchmarking, skills, deficiencies and implications

*C. Müller*¹ – *J. Elliott*^{2,3} – *J. Chryssanthacopoulos*³ – *A. Arneth*⁴ – *J. Balkovič*⁵ – *P. Ciais*⁶ – *D. Deryng*^{7,8} – *C. Folbert*^{5,9} – *S. Hoek*¹⁰ – *T. Iizumi*¹¹ – *R. C. Izaurralde*^{12,13} – *C. D. Jones*¹² – *N. Khabaro*⁵ – *P. J. Lawrence*¹⁴ – *W. Liu*¹⁵ – *S. Olin*¹⁶ – *T. A.M. Pugh*⁴ – *D. K. Ray*¹⁷ – *A. Reddy*¹² – *C. Rosenzweig*¹⁸ – *A. C. Ruane*^{18,2} – *G. Sakurai*¹⁹ – *E. Schmid*²⁰ – *X. Wang*^{6,21} – *A. de Wit*¹⁰ – *X. Wu*⁶

¹ Potsdam Institute for Climate Impact Research, Telegraphenberg A31, 14473 Potsdam, Germany; Christoph.Mueller@pik-potsdam.de; ² Columbia University, Center for Climate Systems Research, New York, NY 10025, USA; ³ University of Chicago, Computation Institute, Chicago, IL 60637, USA; ⁴ Karlsruhe Institute of Technology, IMK-IFU, 82467 Garmisch-Partenkirchen, Germany; ⁵ International Institute for Applied Systems Analysis, Ecosystem Services and Management Program, 2361 Laxenburg, Austria; ⁶ Institute Pierre Simon Laplace, Laboratoire des Sciences du Climat et l'Environnement, Orme des Merisiers, F-91191 Gif-sur-Yvette, France; ⁷ Grantham Research Institute on Climate Change & the Environment, London School of Economics and Political Sciences, London, WC2A 2AE, United Kingdom; ⁸ University of East Anglia, School of Environmental Sciences, Climatic Research Unit, Norwich, NR4 7TJ, United Kingdom; ⁹ Ludwig Maximilian University, Department of Geography, 80333 Munich, Germany; ¹⁰ Alterra Wageningen University and Research Centre, Earth Observation and Environmental Informatics, 6708PB Wageningen, Netherlands; ¹¹ National Institute for Agro-Environmental Sciences, Agro-Meteorology Division, Tsukuba, 305-8604, Japan; ¹² University of Maryland, Department of Geographical Sciences, College Park, MD 20742, USA; ¹³ Texas A&M University, Texas AgriLife Research and Extension, Temple, TX 76502, USA; ¹⁴ National Center for Atmospheric Research, Earth System Laboratory, Boulder, CO 80307, USA; ¹⁵ Swiss Federal Institute of Aquatic Science and Technology, Eawag, CH-8600 Duebendorf, Switzerland; ¹⁶ Lund University, 223 62 Lund, Sweden; ¹⁷ University of Minnesota, Institute on the Environment, Saint Paul, Minnesota 55108, USA; ¹⁸ National Aeronautics and Space Administration, Goddard Institute for Space Studies, New York, NY 10025, USA; ¹⁹ National Institute for Agro-Environmental Sciences, Ecosystem Informatics Division, Tsukuba, JPN; ²⁰ University of Natural Resources and Life Sciences, 1180 Vienna, Austria; ²¹ Peking University, Sino-French Institute of Earth System Sciences, 100871 Beijing, China

Introduction

Severe differences between Global Crop Models (Rosenzweig, et al., 2014) and also between field scale models have been recently reported, following a general call to revisit modeling skills and approaches (Rötter et al., 2011), which is also a central objective of AgMIP (Rosenzweig et al., 2013) and ISI-MIP (Warszawski, et al., 2014). The global scale is especially challenging for model application and evaluation because of the vast differences between regions but also because of the limited availability of reference data at sufficient detail. Global scale models need to be evaluated at the scale of application, which are national or regional aggregates (Nelson et al., 2014).

Materials and Methods

We here provide a broad model evaluation framework to test performance of 15 global gridded crop models (GGCMs) in the AgMIP GGCM project (Elliott, et al., 2015) and beyond and also to identify general and individual model deficiencies across different crops and regions that serve as a basis for further model development and improvement. Model skill is evaluated with respect to correct spatial patterns as well as tem-

poral dynamics at global, country and region scale. We benchmark models against yield reference data (FAOstat data and to two gridded crop yield data sets (Iizumi et al., 2014, Ray, et al., 2012)). To allow for a direct comparison of simulated and observed yields, we apply different de-trending methods and evaluate spatio-temporal correlations of aggregated time series as well as mean yield levels. Automated data processing will allow for establishing a web-based benchmark system that can serve for future global gridded crop model evaluation.

Results and Discussion

Across the ensemble of models, spatio-temporal yield patterns are often well-captured by one or more models for most countries/regions. Generally, all models have good skill in some regions and no model has good skill in all regions. This allows for an intense learning process, as model implementation and parametrization and non-climatic inputs of models with good skills in specific regions can be compared to others and can help to identify deficiencies and regional specifics. Differences in harmonization of non-climatic inputs (growing seasons, fertilizer) as well as secondary output variables spur this learning process. We show results of the overall benchmarking and discuss specific examples of cross-model learning pathways.

References

- Elliott, J., Müller, C., Deryng, D. et al., (2015). The Global Gridded Crop Model Intercomparison: data and modeling protocols for Phase 1 (v1.0). *Geosci. Model Dev.* 8, 261-277.
- Iizumi, T., Yokozawa, M., Sakurai, G. et al., (2014). Historical changes in global yields: major cereal and legume crops from 1982 to 2006. *Global Ecology and Biogeography* 23, 346–357.
- Nelson, G. C., van der Mensbrugge, D., Blanc, E. et al., (2014). Agriculture and Climate Change in Global Scenarios: Why Don't the Models Agree. *Agric. Econ.* 45, 85-101.
- Ray, D. K., Ramankutty, N., Mueller, N. D. et al., (2012). Recent patterns of crop yield growth and stagnation. *Nat. Commun.* 3, 7.
- Rosenzweig, C., Elliott, J., Deryng, D. et al., (2014). Assessing agricultural risks of climate change in the 21st century in a global gridded crop model intercomparison. *Proceedings of the National Academy of Sciences* 111, 3268-3273.
- Rosenzweig, C., Jones, J. W., Hatfield, J. L. et al., (2013). The Agricultural Model Intercomparison and Improvement Project (AgMIP): Protocols and pilot studies. *Agricultural and Forest Meteorology* 170, 166-182.
- Rötter, R. P., Carter, T. R., Olesen, J. E. et al., (2011). Crop-climate models need an overhaul. *Nature Clim. Change* 1, 175-177.
- Warszawski, L., Frieler, K., Huber, V. et al., (2014). The Inter-Sectoral Impact Model Intercomparison Project (ISI-MIP): Project framework. *Proceedings of the National Academy of Sciences of the United States of America* 111, 3228-3232.

Modelling sorghum yield response to heat stress and irrigation: A comparison of three crop growth models

J. B. Naab¹ – H. Webber² – T. Gaiser² – F. Ewert² – P. L. G. Vlek³

¹ WASCAL, BP 9507, Ouagadougou, Burkina Faso; jessenaab@gmail.com

² University of Bonn, INRES, Germany

³ Center for Development Research, University of Bonn, Germany

Introduction

Heat stress is a major cause of yield loss in sorghum and the number of heat events is projected to increase in the future (Liu et al., 2014). Quantifying the future impact of heat stress on sorghum production and developing appropriate adaptation strategies are critical for developing food security policies in West Africa. Biophysical models are essential tools for testing whether predicted increases in temperature are likely to have impact on food production. Understanding the combined effects of heat and water stress on sorghum growth and development is important to improve and test models to predict the consequences of climate change on sorghum production in West Africa. Controlled environment studies have shown that season-long high temperature stress ($\geq 35^{\circ}\text{C}$) from seedling emergence to physiological maturity cause significant reduction in biomass production, grain number, grain weight and yield in sorghum (Prasad et al., 2006a; Nguyen et al., 2013). The objectives of this paper are (i) to present the interactive effects of heat stress and irrigation on the growth, development and yield components of field grown sorghum and (ii) to use the data to test the capability of commonly used sorghum crop growth models to simulate the effects of heat stress and irrigation on growth, development, and yield of sorghum.

Materials and Methods

We conducted field experiments in which three contrasting sorghum varieties were sown on three dates in 2014 and four dates in 2015 during the dry season under full or deficit drip irrigation. Data on phenology, leaf number, biomass production, were measured each year. Canopy temperature was measured 50 cm above the crop each year with infrared sensors. Maximum and minimum air temperature, solar radiation and incidental rainfall were measured daily with a weather station located at the experimental site. At final harvest data on seed number, seed weight and grain yield were determined. Four heat stress indices were calculated centered ten days before and after anthesis and used to evaluate the impact on seed number and grain yield.

Results and Discussion

Mean maximum air temperatures around anthesis decreased from about 40°C in the first and second sowing dates to 32°C in the third and fourth sowing in 2014 and 2015 respectively. Heat stress between heading and physiological maturity significantly impacted seed numbers, seed size and grain yield to different extents depending on

sowing date, variety and irrigation amount. Seed number and grain yield decreased with all four heat stress indices but the correlation was stronger for stress thermal time calculated based on canopy temperature (Figs 1 and 2). The slopes of the regression equations for varieties were significantly different suggesting differences in sensitivity to heat stress.

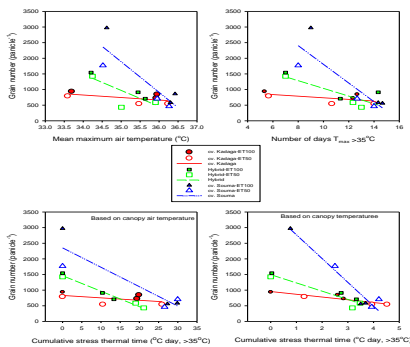

Figure 1. Relationships between grain number and four heat stress indices

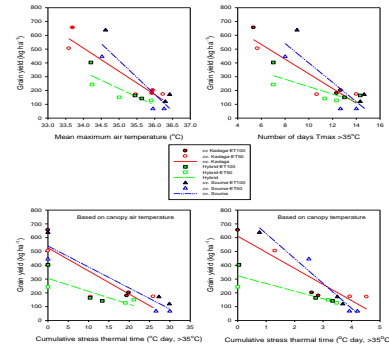

Figure 2. Relationship between grain yield and four heat stress indices

Conclusions

These results confirm controlled environment studies that sorghum yields would be reduced considerably if extreme temperatures (>35°C) become more frequent. Irrigation can help to minimize the impact of heat stress caused by high temperatures. The application of the results to assess the capability of three crop simulation models for sorghum (SIMPLACE, DSSAT, and APSIM) to simulate the impact of extreme heat stress on growth, development and grain yield will be presented.

Acknowledgements

This research was funded by the German Federal Ministry of Education and Research (BMBF) through WAS-CAL.

References

- Liu B., L Liu, L. Tian, W. Cao, Y. Zhu, and S. Asseng (2014). Post-heading heat stress and yield impact in winter wheat of China. *Global Change Biology*, 20: 372-381
- Nguyen, T.C., Singh V., van Oosterom, E.J., Chapman, S.C., Jordan, D.R., Hammer, G.L. (2013). Genetic variability in high temperature effects on seed set in sorghum. *Funct. Plant Biol.* 40, 439-448
- Prasad, P.V.V., K.J. Boote, and L.H. Allen, Jr. (2006a). Adverse high temperature effects on pollen viability, seed set, seed yield and harvest index of grain sorghum [*Sorghum bicolor* (L) Moench] are more severe at elevated carbon dioxide due to higher tissue temperatures. *Agric. For. Meteorol.* 139: 237-251

Soil nitrogen mineralisation simulated by crop models across different environments and the consequences for model improvement

*C. Nendel*¹ – *P. Thorburn*² – *D. Melzer*¹ – *C.E.P. Cerri*³ – *L. Claessens*⁴ – *P.K. Aggarwal*⁵ – *M. Adam*⁶ – *C. Angulo*⁷ – *S. Asseng*⁸ – *C. Baron*⁹ – *B. Basso*¹⁰ – *S. Bassu*¹¹ – *P. Bertuzzi*¹² – *C. Biernath*¹³ – *H. Boogaard*¹⁴ – *K. J. Boote*¹⁵ – *N. Brisson*^{12,Δ} – *D. Cammarano*¹⁶ – *S. Conijn*¹⁷ – *M. Corbeels*¹⁸ – *D. Deryng*¹⁹ – *G. De Sanctis*²⁰ – *J. Doltra*²¹ – *J. L. Durand*²² – *F. Ewert*²³ – *S. Gayler*²⁴ – *R. Goldberg*¹⁹ – *R. Grant*²⁵ – *P. Grassini*²⁶ – *L. Heng*²⁷ – *S. B. Hoek*¹⁴ – *J. Hooker*²⁸ – *L.A. Hunt*²⁹ – *J. Ingwersen*²⁴ – *C. Izaurralde*³⁰ – *R. Jongschaap*¹⁷ – *A. Kemanian*³¹ – *K. C. Kersebaum*¹ – *J. Lizaso*³² – *D. Makowski*¹¹ – *P. Martre*³³ – *C. Müller*³⁴ – *S. H. Kim*³⁵ – *S. Naresh Kumar*³⁵ – *G. O’Leary*³⁶ – *J. E. Olesen*³⁷ – *T. Osborne*³⁸ – *T. Palosuo*⁴⁰ – *M. V. Pravia*³¹ – *E. Priesack*¹² – *D. Ripoche*¹¹ – *R. P. Rötter*⁴⁰ – *F. Sau*³² – *M. A. Semenov*⁴¹ – *I. Shcherbak*⁹ – *P. Steduto*⁴² – *C. Stöckle*⁴³ – *P. Stratonovitch*⁴¹ – *T. Streck*²⁴ – *I. Supit*⁴⁴ – *F. L. Tao*⁴⁰ – *E. Teixeira*⁴⁵ – *D. Timlin*⁴⁶ – *M. Travasso*⁴⁷ – *K. Waha*² – *D. Wallach*⁴⁸ – *J. W. White*⁴⁹ – *J. Wolf*⁴³

1 Leibniz Centre for Agricultural Landscape Research, LSA, Eberswalder Straße 84, 15374 Müncheberg, Germany, nendel@zalf.de; 2 CSIRO Agriculture, Brisbane, Australia; 3 Soil Science, ESALQ, U São Paulo, Piracicaba, Brazil; 4 ICRISAT, Nairobi, Kenya; 5 CGIAR, IWMI, New Delhi, India; 6 UMR AGAP/PAM, CIRAD, Montpellier, France; 7 PITROS, U Bonn, Germany; 8 ABE Dep., U Florida, Gainesville, USA; 9 UMR TETIS, CIRAD, Montpellier, France; 10 GS and W.K. Kellogg Biol. Station, MSU East Lansing, USA; 11 Unite d’Agronomie, INRA-AgroParisTech, Thiverval-Grignon, France; 12 INRA AgroClim, Avignon, France; 13 ISE, Helmholtz Zentrum München, Neuherberg, Germany; 14 Centre for Geo-Information, Alterra, Wageningen, The Netherlands; 15 Agronomy, U Florida, Gainesville, USA; 16 Information and Computational Sci., The James Hutton Institute, Dundee, Scotland, UK; 17 Wageningen UR Agrosystems Research, The Netherlands; 18 CIRAD, C/O Embrapa-Cerrados, Planaltina, Brazil; 19 NASA Goddard Institute for Space Studies, New York, USA; 20 Institute for Environment and Sustainability, JRC, Brussels, Belgium; 21 Cantabrian Agricultural Research and Training Centre, Muriedas, Spain; 22 Dép. Environnement & Agronomie, INRA, Lusignan, France; 23 INRES, U Bonn, Germany; 24 Soil Science and Land Evaluation, U Hohenheim, Stuttgart, Germany; 25 Renewable Resources, U Alberta, Edmonton, AB, Canada; 26 Agronomy & Horticulture, U Nebraska, Lincoln, USA; 27 IAEA, Vienna, Austria; 28 Agriculture, U Reading, UK; 29 Plant Agriculture, U Guelph, Canada; 30 Geogr. Sci., U Maryland, USA; 31 Plant Sci., Pennsylvania State U, USA; 32 Dep. Producción Vegetal, Fitotecnia, U Politécnica of Madrid, Spain; 33 INRA SupAgro, UMR LEPSE, Montpellier, France; 34 Potsdam Institute for Climate Impact Research, Germany; 35 School of Environ. & Forest Sci., College of the Environment, U Washington, USA 36 Environ. Sci., Indian Agr. Res. Inst., PUSA, New Delhi, India; 37 Landscape & Water Sciences, Primary Industries, Horsham, Australia; 38 Agroecology, Climate and Bioenergy, Tjele, Denmark; 39 Meteorology, U Reading, UK; 40 Natural Resources Inst. (Luke), Vantaa, Finland; 41 Computational and Systems Biology, Rothamsted Res., Harpenden, UK; 42 FAO, Rome, Italy; 43 BSE, WSU, Pullman, USA; 44 PPS and ESS, Wageningen U, The Netherlands; 45 *Sustainable Production, The New Zealand Institute for Plant & Food Research Ltd, Lincoln, New Zealand*; 46 USDA/ARS, Crop Systems and Global Change Lab, Beltsville, MD, USA; 47 Institute for Climate and Water, INTA-CIRN, Castelar, Argentina; 48 INRA, Castanet-Tolosan, France; 49 Arid-Land Agricultural Research Center, Maricopa, AZ, USA; ΔThe authors regret Nadine Brisson passing away during the study in 2011.

Introduction

Crop models are the state-of-the-art tool to predict crop yields in the context of climate change and food security. The uncertainty associated with their use can be partly overcome by using multi-model ensembles (*mme*), though model improvement

is still an important consideration (Rötter et al., 2011). Model intercomparison identifies processes that are well represented by some models, but insufficiently simulated by others. The initial concept relies on testing against high-quality field data under the assumption that the observed crop was grown without limitations. In the case of nitrogen (N) supply to the crop, unlimited growth of the simulated crop can be easily assured if sufficient mineral N fertiliser is applied. However, in low-N systems, N supply to the virtual crop highly depends on how the model simulates soil organic matter turnover and subsequent N release.

Materials and Methods

We revisited the crop growth simulations of *mmes* for wheat (Asseng et al., 2013) and maize (Bassu et al., 2014) and analysed the simulated N mineralisation dynamics for eight different sites. The simulated N supply is discussed in the context of existing observations for N mineralisation from soils of different environments and of the consequences for model improvement.

Results and Discussion

Analysis reveals that within the *mmes* the simulated N mineralisation courses produce a range of N supply levels from 24 to 160 kg N ha⁻¹ at a site in Argentina. Here, 120 kg N ha⁻¹ additional fertiliser was given, but a considerable number of models still simulated N stress of the grown wheat crop. A subsequent crop parameter adjustment under the assumption of unlimited N supply may have failed in some of these cases due to violation of the precondition (Table 1). The simulation of N stress, when none occurred, would have contributed to the variability between models. Investigating the N-related processes seems promising to further improve the models, leading to reduced uncertainty in *mmes*.

Table 1. Preconditions for crop parameter optimisation arising from observed vs simulated soil conditions.

	Observed crop	
	N limited	Not N limited
N stress simulated	Simulation reflects the site conditions well. However, basic assumption for the simulation study violated (non-optimal conditions for plant growth).	N supply underestimated. Crop parameter adjustment probably the wrong handle. Site conditions match the basic assumption of optimal growth.
N stress not simulated	N supply overestimated. Model assumes optimal growth, which is not the case. Crop parameter adjustment may go astray.	Site conditions match the basic assumption (optimal growth). Crop parameter adjustment feasible according to the study's objective.

References

- Asseng, S., et al., (2013): Quantifying uncertainties in simulating wheat yields under climate change. *Nature Clim. Change* 3, 827–832.
- Bassu, S., (2014): How do various maize crop models vary in their responses to climate change factors? *Glob. Change Biol.* 20 (7), 2301–2320.
- Rötter, R.P., T.R. Carter, J.E. Olesen, J.R. Porter (2011). Crop-climate models need an overhaul. *Nat. Clim. Change* 1, 175–177.

Addressing uncertainty in model input and evaluation data

K. Nicklin – A. Challinor

School of Earth and Environment, University of Leeds, Leeds, UK. k.nicklin@leeds.ac.uk

Introduction

In crop modelling studies uncertainty in crop calendars and in observed yields is usually overlooked. However, in some regions errors in this data are large. Widely used crop calendar data sets such as Sacks et al., (2010) tend to have just one planting and harvesting window for each country. This is inadequate for regions where there is within-country variation in cropping seasons (e.g. East Africa, figure 1). Common issues with observed crop yield data include inconsistencies between different data sets, missing data, unrealistically high yields and identical yields in consecutive years (e.g. figure 2). In most cases there is not enough information to quantify the uncertainty from crop calendar and observed yield data sets. However, the errors in this data should not be ignored as they will affect the simulated yields and estimates of model performance (e.g. Watson and Challinor 2013). Therefore, this study presents improved methods of using the available data in order to reduce crop model error.

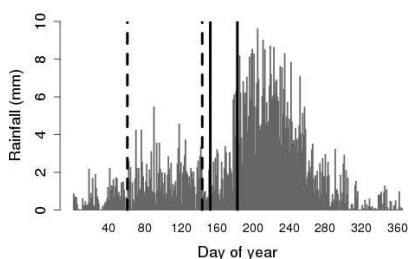

Figure 1. Average daily rainfall at the Melkassa research station in Ethiopia, the Sacks planting window (black dashed lines) and the planting window actually used (black solid lines).

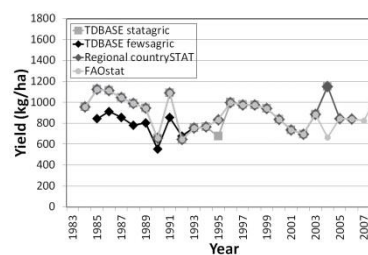

Figure 2. Sorghum yield for Mali reported by four different (but not independent) datasets.

Materials and Methods

A procedure was developed to define realistic planting windows and select suitable crop development parameters (referred to as varieties) for rain-fed cropping regions where this information is unavailable or inadequate:

1. Divide the study area into separate regions according to the rainfall regime.
2. Use available literature to define a realistic planting window for each region and divide this into a number of 10-day planting windows.
3. For each grid cell, calculate the average date on which the rainy season ends.
4. Define a set of realistic varieties spanning the range of required durations.
5. For each grid cell and 10-day planting window, select the variety that results in average maturation dates closest to the average end of the rainy season.

6. Simulate crop yield for each grid cell and 10-day planting window then average yields over 10-day planting windows, excluding the crops that fail to emerge.

This procedure was used with the GLAM crop model to simulate maize yields across East Africa. Yields were also simulated using the Sacks planting windows and the varieties that matured within the Sacks harvesting windows.

An error checked observed yield data set for groundnut and sorghum was produced for nine countries in West Africa. In order to remove unrealistically high yields, any yield above a given threshold (in this case 2000 kg/ha) was examined and removed unless yields in the surrounding regions also peaked that year.

Results and Discussion

Realistic planting windows and varieties that mature around the end of the rainy season were defined for each grid cell in East Africa (e.g. figure 3). Using the Sacks crop calendar information can result in unrealistic periods of drought during crop growth and therefore unrealistically low simulated yields (e.g. figure 4, 1999 and 2000). The new procedure avoids this and improves the crop model performance.

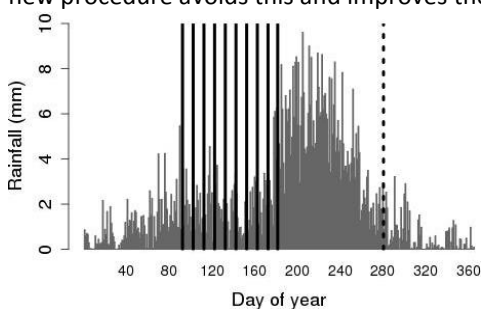

Figure 3. Average daily rainfall at the Melkassa research station, the realistic planting window divided into 10-day planting windows (black solid lines) and the mean end of rainfall season (black dotted line).

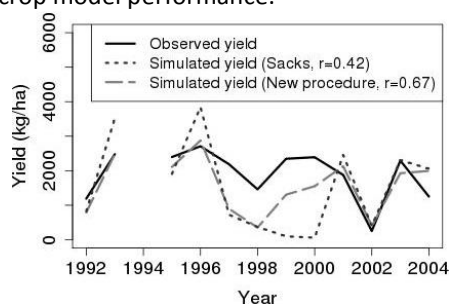

Figure 4. Maize yields at the Melkassa research station. Observed yields courtesy of Helen Greatrex, Andualem Shimeles, Fikadu Getachew (Ethiopian Institute of Agricultural Research).

Conclusions

It is important to recognize the hidden uncertainty due to crop calendar and observed yield data sets. This study presents methods to reduce this uncertainty and improve yield simulations. However, improvement of these data sets should be a top priority.

Acknowledgements

The research leading to these results has received funding from the European Union Seventh Framework Programme under the SPECS project (grant agreement n° 308378) and the EUPORIAS project (grant agreement n° 308291)

References

- Sacks, W.J., D. Deryng, J.A. Foley, N. Ramankutty (2010). *Global Ecology and Biogeography*, 19: 607-620
 Watson, J. and A.J. Challinor (2013) *Agricultural and Forest Meteorology*, 170: 47-57

Comparison of wheat models and their sensitivity towards tillage and N fertilization with different calibration approaches

J. E. Olesen^{1*} – *B. Sharif*¹ – *F. Plauborg*¹ – *X. Yin*¹ – *M. Bindi*² – *L. Doro*³ – *F. Ewert*⁴ – *R. Ferrise*² – *T. Gaiser*⁴ – *L. Giglio*⁵ – *H. Hoffmann*⁴ – *M. Hoffmann*⁶ – *K. C. Kersebaum*⁷ – *I. Iocola*³ – *M. Moriondo*⁸ – *L. Mula*³ – *P. P. Roggero*^{3,9} – *D. Ventrella*⁵

¹ Department of Agroecology, Aarhus University, Blichers Allé 20, Tjele, Denmark, jeo@agro.au.dk

² Department of Agri-food Production and Environmental Sciences – University of Florence, Italy

³ Nucleo di Ricerca sulla Desertificazione-NRD, University of Sassari, Italy

⁴ Crop Science Group, Institute of Crop Science and Resource Conservation (INRES), University of Bonn, Germany

⁵ Consiglio per la ricerca in agricoltura e l'analisi dell'economia agraria (CREA) - Unità di ricerca per i sistemi colturali degli ambienti caldo-aridi (CREA-SCA), Bari, Italy

⁶ Crop Production Systems in the Tropics; Georg-August-Universität Göttingen, Germany

⁷ Institute of Landscape Systems Analysis, Leibniz Centre for Agricultural Landscape Research (ZALF), Müncheberg, Germany

⁸ CNR IBIMET, Florence, Italy

⁹ Dipartimento di Agraria, University of Sassari, Italy

Introduction

Comparison of crop models can help to identify those modules of models that produce systematic errors and require improvements (Porter et al., 1993). There are several studies comparing different mechanistic wheat models with respect to their performance in predicting yield and yield variability in response to climate and other environment factors since 1980s (Porter et al., 1993; Wolf et al., 1996; Semenov et al., 1996; Jamieson et al., 1998; Landau et al., 1998). Most inter-model comparison studies were based on one offset of model calibrations; however, different calibration methods and different sets of data for calibration can reduce the uncertainty of model output in different ways (Asseng et al., 2013). There are few studies that have considered responses of different wheat models against different management and rotations. Therefore, we use data from a detailed winter wheat experiment data in Foulum, Denmark in 2013 and 2014 under different tillage and fertilization practices to calibrate and validate different wheat models with different calibration methods.

Materials and Methods

The experiment was a long-term randomized split-split-plot design with four replications and three factors: two crop rotations (namely R2 and R4) in the main plots, two tillage practices (direct drilling and ploughing) as sub-plots, and nitrogen (N) fertilization rates as sub-sub-plots. Fertilization treatments were applied in 2013 and 2014 with low, normal and high rates of N. In 2013, rates were 50, 150 and 250 kg N ha⁻¹, while in 2014 they were 65, 165 and 265 kg N ha⁻¹. In total, as described, nine management practices were considered in this study. Table 1 shows the design of the modelling experiment. Table 2 shows the applied calibration steps. Seven crop models

(APSIM, CROPSYST, DAISY, DSSAT, EPIC, HERMES, SIMPLACE<LINTUL>) by nine modelling teams were applied in this study.

Table 1. The design of the modelling experiment and the corresponding treatment codes

Rotation	Tillage\Fertilization	Low N	Normal N	High N
Rotation 4	Ploughed	PL4	PN4	PH4
	Direct drilling (No tillage)	DL4	DN4	DH4
Rotation 2	Ploughed	PL2	PN2	PH2

Table 2. Calibration steps and their corresponding observation data

	Calibration data	Frequency
Step 1	Phenology (growth stage)	3 times a week
Step 2a (low N)	Final yield and grain N	Once at harvest
Step 2b (same sub-plots as step 2a)	- Soil water content	3 times a week
	- Above ground biomass, Area index, Soil mineral N, Plant total N	Once a fortnight
	- Root biomass and N	Once around flowering
Step 3a	Same type of data in step 2a, but for Normal N subplots	
Step 3b	Same type of data in step 2b, but for Normal N subplots	

Results

Figure 1 shows that crop models respond quite differently to increased nitrogen rates. Calibration improved the prediction power of the models, but in many cases it did not change the responses to management factors.

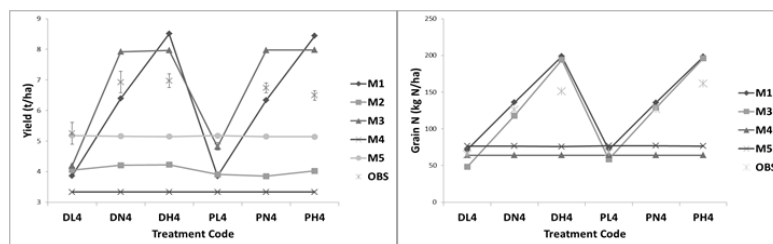

Figure 1. Response of 5 models to different tillage and N fertilization treatments at step 1 in 2013 (final dry matter yield and grain N for different treatments). Model M2 could not output Grain N.

References

- Porter J.R., P.D. Jamieson, D.R. Wilson (1993). Field Crops Research, 33, 131-157.
- Wolf J., L. Evans, M. Semenov et al., (1996). Climate Research, 7: 253-270.
- Semenov M., J. Wolf, L. Evans et al., (1996). Climate Research, 7: 271-281.
- Jamieson P., M. Semenov, I. Brooking, G. Francis (1998). European Journal of Agronomy, 8: 161-179.
- Landau S., R. Mitchell, V. Barnett et al., (1998) Agricultural and Forest Meteorology, 89: 85-99.
- Asseng S., F. Ewert, C. Rosenzweig et al., (2013). Nature Climate Change, 3: 827-832.

Analyzing the effect of catch crops on nitrate leaching in a maize cropping system under climate change using response surface approach

I. Öztürk – I. K. Sillebæk – S. Baby – J. E. Olesen

Department of Agroecology, Aarhus University, Blichers Alle 20 DK-8830, Tjele, DENMARK

Introduction

In Denmark, the traditional fodder crops are being substituted by maize due to both climatic and non-climatic conditions. However, there is insufficient knowledge on nitrogen (N) use of maize and related agro-ecological consequences considering the climate change. In this study, we examined the nitrate leaching from a maize production system using the impact response surface method across ten thousand sensitivity tests covering an uncertainty space in temperature, precipitation, and CO₂.

Materials and Methods

The changes of climate variables extend within the climate extremes projected by CMIP5. The tests were generated using a Latin Hypercube sampling method (Ruane et al., 2014) and the changes were applied to a baseline (1999 - 2011). A soil-crop model (FASSET) was used to simulate the maize growth in response the climate change. FASSET was calibrated and validated using data that were collected from field experiments conducted in 2009 – 2011 in Denmark at two sites with different soil characteristics under rotations without any catch crops (denoted by A), and two different catch crops (denoted by B - C), as well as using different fertilization rates at 1N, (recommended level of N to be applied denoted by 1), ½N (denoted by 2), and 1½N (denoted by 3). The experiments included 10-year cropping history of either maize for silage, or grass-clover.

Results and Discussion

The results indicated that temperature during growing season was the most important variable affecting nitrate leaching. The availability of mineral N decreased with increased temperature while the amount of nitrate leached increased. Denitrification has also increased with the increased temperature and the amount of N applied to the cropping system, suggesting the increased N supply will not increase available N in the soil but simply get emitted into the atmosphere.

Increased N fertilization did not increase yield either, but increased N leaching. Catch crops were found to be beneficial in reducing nitrate leaching. The type of catch crop has also affected leaching at a different rate. For example, rygrass at 1½N application was found to be more effective in reducing the leaching than red fescue at the same N rate.

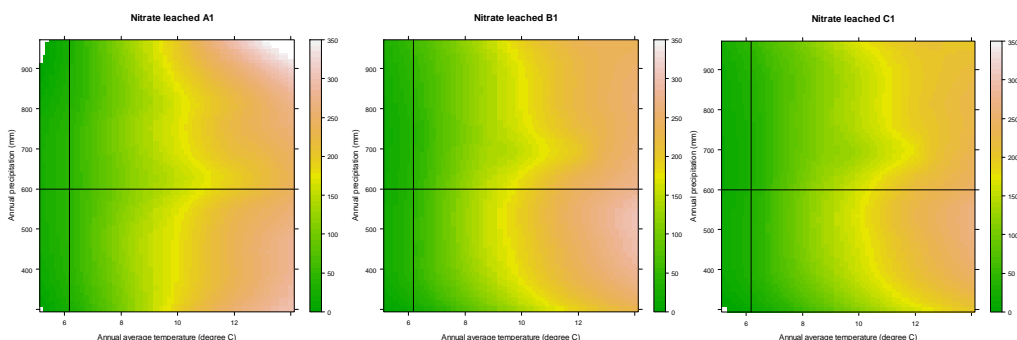

Figure 1. A sample figure of Nitrate leaching response in relation to temperature and precipitation changes at $\frac{1}{2}$ N using no catch crops (A), Red fescue (B), and Ryegrass (C). The color key indicates the amount of nitrate leached in kg ha^{-1} . The vertical and horizontal black lines indicate the annual average of temperature and annual sum of precipitation of the baseline during which the field experiments carried out.

Conclusions

This study emphasized that that croplands in Denmark will likely experience more N losses in the future unless adaptation measures are developed and implemented. In addition, the grain quality will likely fall due to diluted organic N content in the plants as indicated by increased N losses. In this respect, mono cropping systems based solely on mineral fertilization will not be a sustainable crop production method under a warmer and wetter climate. Greater reliance on ammonium fertilizers and nitrification inhibitors might counteract the projected increase in nitrate leaching in the future.

Acknowledgements

This work was carried out within the project EfterMajs funded by SEGES organization under the Danish Agriculture and Food Council, and the "INTERREG 4A South Denmark-Schleswig-K.E.R.N. program" supported by European Regional Development Fund

Reference

Ruane AC, McDermid S, Rosenzweig C, Baigorría GA, Jones JW, Romero CC, Cecil L (2014) Carbon-Temperature-Water change analysis for peanut production under climate change: a prototype for the AgMIP Coordinated Climate-Crop Modeling Project (C3MP). *Global Change Biology* 20, 394-407.

Optimal photosynthetic nitrogen partitioning in cucumber leaves for maximizing canopy photosynthesis

Y.-C. Pao¹ – T.-W. Chen^{1,2} – H. Stützel¹

¹ Institute of Horticultural Production Systems, Faculty of Natural Sciences, Leibniz University Hanover, Herrenhäuser Str. 2, D-30419 Hanover, Germany, e-mail: pao@gem.uni-hannover.de

² INRA, UMR759 Laboratoire d'Ecophysiologie des Plantes sous Stress Environnementaux, Place Viala, F-34060 Montpellier, France

Introduction

In response to considerable variation in light intensity within the canopy, the partitioning of nitrogen (N) to various photosynthetic functions should vary to achieve efficient utilization of light. Here, photosynthetic N partitioning (PNP) is defined as optimum when the whole canopy photosynthesis is maximized. The objective of this work is to identify the optimal PNP in cucumber leaves as dependent on light conditions, and to determine the discrepancy between actual and optimum at both leaf and canopy level.

Materials and Methods

Cucumber cv. 'Aramon' was grown hydroponically in a growth chamber to determine the empirical PNP (ENP). Twenty-four leaves, which had been positioned perpendicularly to constant light intensities ranging from 5-40 mol m⁻² d⁻¹ daily photon irradiance (DPI). The PNP of these leaves was determined based on Niinemets and Tenhunen (1997) and Buckley et al., (2013). PNP fractions for carboxylation (f_v) and electron transport (f_j) were calculated from their maximum rates, V_{cmax} and J_{max} , respectively. The fraction in light harvesting (f_c) was calculated from leaf chlorophyll content. f_v and f_j were described depending on DPI using monomolecular functions with three parameters, $f_{x,max}$, d_x and a_x :

$$f_x = f_{x,max} [1 - d_x \times \exp(-a_x \times I_d)] \quad (1)$$

f_c was calculated as:

$$f_c = 1 - f_v - f_j \quad (2)$$

To test the optimal PNP, a multi-layer model representing a canopy with 25 layers was constructed to simulate daily canopy CO₂ assimilation (DCA) depending on PNP in each layer and DPI above the canopy. Each layer was different in leaf area, specific leaf area, N content, local light intensity (I_d) and PNP, which is used to determine the photosynthetic variables, V_{cmax} , J_{max} and chlorophyll content, in the layer. Layer structural characteristics and total N content were determined by a greenhouse experiment. PNP was calculated by Eqn 1 and 2 depending on I_d , which was simulated for each layer in the canopy using Lambert-Beer law. The diurnal irradiance above the canopy was simulated by a simple cosine bell function (Kimball and Bellamy, 1986).

Using this model, the dependency of DCA on DPI above the canopy (5-50 mol m⁻² d⁻¹) was simulated and compared between ENP, the theoretically optimal PNP (TNP) pro-

posed by Buckley et al., (2013), and several different optimal PNP patterns. These optimal PNP patterns were derived from ENP by changing the three parameters in Eqn 1 by which maximum DCA was obtained under a given DPI above the canopy. The variation of the parameters were constrained between 0 and two-fold of the original values in ENP functions.

Results and Discussion

DCA simulated with TNP is up to 16 % higher than ENP under various DPI above the canopy. This suggests that developmental acclimation of PNP to light intensity in cucumber cv. 'Aramon' is not optimal. f_v of ENP is higher and f_j of ENP is lower than those of TNP throughout the whole range of I_d , suggesting that N might be over-invested in carboxylation and under-invested in electron transport .

With the optimal PNP patterns derived from ENP, up to 20 % DCA can be theoretically increased over the typical light regimes in the greenhouse. To improve PNP in cucumber leaves, a higher proportion of photosynthetic N should be invested into electron transport instead of into carboxylation under low I_d , while under high I_d , more photosynthetic N should be partitioned into electron transport instead of into light harvesting function. In the actual canopy, chlorophyll content is higher than optimum throughout the canopy. V_{cmax} exceeds optimum below middle layers, while V_{cmax} and J_{max} are both considerably lower than optimum in the upper layer.

Conclusions

20 % higher DCA could be obtained with optimal PNP. At leaf level, a higher proportion of photosynthetic N should be partitioned into electron transport from carboxylation and light harvesting functions. At canopy level, photosynthetic variables are not optimal. In the upper canopy, a higher proportion of photosynthetic N should be partitioned from light harvesting to carboxylation and electron transport. Below middle canopy, a higher proportion of photosynthetic N should be partitioned from light harvesting and carboxylation to electron transport.

Acknowledgements

Many thanks to Ilona Napp, Marlies Lehmann, and Dr. Dany Pascal Moualeu.

References

- Buckley, T.N., A. Cescatti A. and G.D. Farquhar (2013). *Plant, Cell & Environment*, 36: 1547–1563.
- Niinemets, Ü. and J.D. Tenhunen (1997). *Plant, Cell & Environment*, 20: 845–866.
- Kimball, B.A. and Bellamy L.A. (1986). *Energy in Agriculture*, 5: 185–197.

Framework to Advance Climate, Economic, and Impact Investigations with Information Technology (FACE-IT)

C. Porter¹ – J. Elliott² – W. Xiong¹ – M. Zhang¹ – D. Kelly² – A. Brizius² – R. Montella³ – R. Madduri² – I. Foster² – J. W. Jones¹

¹ Agricultural & Biological Engineering Department, University of Florida, PO Box 110570, Gainesville, FL, USA 32611, (corresponding author: Cheryl Porter, cporter@ufl.edu)

² Computation Institute, Argonne National Laboratory and University of Chicago,

³ Department of Science and Technologies, University of Naples Parthenope

Introduction

One challenge facing AgMIP (Agricultural Model Intercomparison and Improvement Project, Rosenzweig et al., 2013) modelers in Regional Research Teams (RRTs) is the computationally intensive analyses of Regional Integrated Assessments (RIAs), given the limited capacity of desktop computers. Researchers must create and manage complex data sets, and master tools for data pre-processing, ensemble model simulations, post-processing, and model intercomparison. To address these challenges, we developed the Framework to Advance Climate, Economic, and Impact Investigations with Information Technology (FACE-IT, Montella et al., 2015) for climate impact assessments. FACE-IT provides an IT infrastructure that extends the capabilities of biophysical model-based research activities, using the AgMIP RIA workflow as the primary use case.

Materials and Methods

This integrated data processing and simulation framework leverages high-performance and cloud computing to produce aggregated yields and ensemble variables needed for statistics, for model intercomparison, and to connect biophysical models to global and regional economic models. FACE-IT was built on the Globus Galaxies platform (Madduri et al., 2015), developed primarily for genetics data processing and analysis, to enable the capture of workflows and outputs in well-defined, reusable, and comparable forms (see Fig 1). By providing ready access to not only data but also the software tools used to process data for specific uses (e.g., generation of weather data for future climate scenarios, translation of management data to multiple model formats (Porter et al., 2014), running crop models for various climate and socioeconomic scenarios), FACE-IT allows researchers to concentrate their efforts on analysis.

Results and Discussion

With development still ongoing, FACE-IT has entered an operational phase, with AgMIP RRTs in South Asia and Sub-Saharan Africa using apps and workflows designed for RIAs. FACE-IT apps now allow much of the data translation, model simulation, and post processing analysis and visualization activities to be performed remotely on the Amazon EC2 cloud, controlled through a Web browser interface. FACE-IT accomplishes these

goals by building and integrating a number of web-based software tools to enable researchers to easily develop data manipulation and analysis applications, apply those apps to their own data and to data provided by others, link multiple apps into data analysis pipelines, and share such pipelines with their collaborators and the community. Monthly “help-desk” webinars allow researchers to interact with the development team to troubleshoot problems and provide feedback on bugs and future enhancements. Researchers at the Crops for the Future (www.cropsforthefuture.org) research organization are developing additional apps for use in their research on an instance of FACE-IT set up on a private server.

Conclusions

The FACE-IT platform is already proving to be a useful tool for AgMIP RRTs, allowing many millions of simulations to be done using cloud services, but fully controlled in an intuitive web-based visual interface.

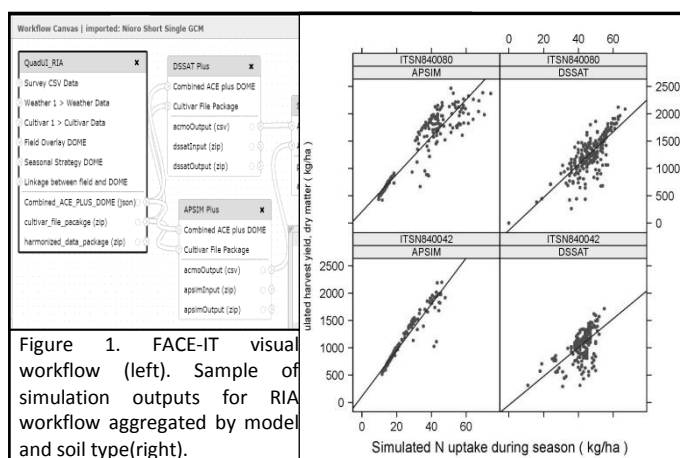

Figure 1. FACE-IT visual workflow (left). Sample of simulation outputs for RIA workflow aggregated by model and soil type(right).

Acknowledgements

We thank the Globus Galaxies, Globus, and Galaxy teams for their outstanding work on those systems and for their assistance with this project. This work was supported by the NSF cyberSEES program award ACI-1331782, the NSF Decision Making Under Uncertainty program award 0951576, and the DOE under contract DE-AC02-06CH11357. EC2 resources have been generously provided by Amazon.

References

Madduri R, Chard K, Chard R, Kelly D, Dave U, Foster I. (2015). The Globus Galaxies platform: delivering science gateways as a service. *Concurrency and Computation – Practice and Experience*. DOI: 10.1002/cpe.3486.

Montella, R., Kelly, D., Xiong, W., Brizius, A., Elliott, J., Madduri, R., Maheshwari, K., Porter, C., Vilter, P., Wilde, M., Zhang, M., and Foster, I. (2015) FACE-IT: A science gateway for food security research. *Concurrency Computat.: Pract. Exper.*, doi: 10.1002/cpe.3540.

Porter, C.H., C. Villalobos, D. Holzworth, R. Nelson, J.W. White, I.N. Athanasiadis, S. Janssen, D. Ripoche, J. Cufi, D. Raes, M. Zhang, R. Knapen, R. Sahajpal, K.J. Boote, J.W. Jones. (2014). Harmonization and translation of crop modeling data to ensure interoperability. *Environmental Modelling and Software*. 62:495-508.

Rosenzweig C, Jones J, Hatfield J, Ruane A, Boote K, Thorburn P, Antle J, Nelson G, Porter C, Janssen S, et al., (2013). The agricultural model intercomparison and improvement project (AgMIP): protocols and pilot studies. *Agricultural and Forest Meteorology*; 170:166–182.

Widespread vulnerability of current crop production to climate change demonstrated using a data-driven approach

T. A. M. Pugh^{1,} – C. Müller² – J. Elliott³ – A. Arneth¹*

¹ Institute of Meteorology and Climate Research, Atmospheric Environmental Research, Karlsruhe Institute of Technology, 82467 Garmisch-Partenkirchen, Germany. thomas.pugh@kit.edu

² Potsdam Institute for Climate Impact Research, 14473 Potsdam, Germany.

³ University of Chicago and Argonne National Laboratory Computation Institute, Chicago, IL, 60637

Introduction

The projected increase in global population suggests that, among a range of measures, a large increase in food production will likely be necessary to achieve food security (Alexandratos and Bruinsma 2012). A great deal of effort has been focused on the so-called “yield gap”, the difference between actual and maximum-attainable yields (Mueller et al., 2012). The closing of this yield gap would bring about massive increases in production. Intensification actions such as irrigation, fertilisation, and better farming practices can bring the actual yield closer to the potential yield, although such actions may not be practical everywhere. Yet climate change greatly complicates this picture; crops are sensitive to their growing environment, and it is therefore inevitable that climate change will impact upon potential crop yields, changing the target for which intensification measures are aiming, and meaning that significant intensification may be required just to hold actual yields constant. Global crop models give some insight into such changes, but huge uncertainties in their process representations currently means that even the direction of future change remains uncertain (Rosenzweig et al., 2014).

Materials and Methods

We demonstrate a complementary data-driven approach, based on observations of current maximum-attainable yield and climate analogues (Williams et al., 2007; Koven 2013), to assess the vulnerability of yields of the three major cereal crops, wheat, maize and rice, to climate change. Present-day analogues of future climate are defined based on outputs from five CMIP5 GCMs (Hempel et al., 2013), and combined with information on current maximum-attainable yield (Mueller et al., 2012) to derive global, spatially-explicit, changes in crop yield potential over the 21st century. The results are compared and contrasted against output from an ensemble of global gridded crop models (Rosenzweig et al., 2014).

Results and Discussion

We find that huge swathes of current cropland show strong reductions in their potential yields of major cereal crops by the mid 21st century (Table 1), indicating a large vulnerability of crop production in these areas to climate change, and greatly reducing the capacity for intensification of yields. These reductions are predominately

in tropical or arid areas, and include current high-productivity areas like the North American corn-belt. Conversely, however, we also find large areas where potential yields increase substantially under climate change. These areas are most prominent in the northern temperate zone, and include areas not currently under cropland. Analogues for mid.-latitude croplands are typically drawn from regions 1000km or more closer to the equator, and even from tropical regions, suggesting that present-day investment in more southerly, or even tropical, climates may pay dividends in temperate regions in the future. Our approach is independent of the crop modelling methodologies previously used for future yield projections, however we find our results to be consistent with those from an ensemble of process-based global crop models, providing an important additional constraint on projections of future yield under climate change.

Table 1. Percentage of current global harvested area in areas showing reductions in attainable yield for at least 4 out of 5 GCM climates.

Crop	2041-2060	2081-2099
Maize	47	64
Wheat	27	33
Rice	25	26

Conclusions

We provide clear, independent evidence, that climate change is likely to decrease production from staple food crops across the tropics and much mid-latitude cropland already by the middle of the 21st century. Attempts to intensify crop production in these regions are likely to provide much more limited benefits when climate change is considered. Our results suggest that large shifts in land-use patterns, taking advantage of increased yield potential in regions which are currently lightly-cropped, will likely be necessary to sustain production growth rates and keep pace with demand.

Acknowledgements

The authors thank members of the AgGRID global gridded crop model intercomparison project are thanked for making available their crop modelling data, and in particular Stefan Olin, Delphine Deryng and Christian Folberth for useful comments on an early version of the analysis. This work was funded by the European Commission's 7th Framework Programme, under Grant Agreement number 603542 (LUC4C).

References

- Alexandratos, N., Bruinsma, J. (2012) World Agriculture towards 2030/2050: The 2012 Revision. ESA Working Paper No. 12-13.
- Hempel, S. et al., (2013) *Earth System Dynamics*, 4: 219–236.
- Koven, C.D. (2013) *Nature Geoscience*, 6: 452–456.
- Mueller, N.D. et al., (2012) *Nature*, 490: 254–257.
- Rosenzweig, C. et al., (2014) *Proceedings of the National Academy of Sciences of the United States of America*, 111: 3268–3273.
- Williams, J.W., Jackson, S.T., Kutzbach, J.E. (2007) *Proceedings of the National Academy of Sciences of the United States of America*, 104: 5738–5742.

Modelling adaptive traits to screen for salinity tolerance in rice

A. M. Radanielson¹ – D. S. Gaydon^{2,3} – O. Angeles¹ – T. Li¹ – A. M. Ismail¹

¹ International Rice Research Institute, Philippines, a.radanielson@irri.org, o.angeles@irri.org, t.li@irri.org, a.ismail@irri.org

² CSIRO Agriculture Flagship, Brisbane, Australia, ³ School of Agriculture and Food Sciences, University of Queensland, St Lucia, Brisbane, Australia, don.gaydon@csiro.au

Introduction

Climate change is expected to increase the severity and occurrence of salinity in irrigated rice systems, leading to reduction of cultivated areas and productivity. The use of salt-tolerant varieties is among potential adaptive strategies to maintain productivity in this condition (Ismail et al., 2007; Deryng et al., 2011). The conventional selection strategy to develop salt tolerant varieties is limited by time and site specific management, particularly with the temporal and spatial variability of salinity dynamics in the field. Simulation modelling has been useful to explore possible combinations of crop traits in a time-effective manner, and to assess variety performance in real environments (Cooper et al., 2005; Chenu et al., 2011). By integrating advances in crop physiology, crop modelling can be used to assist breeding programs by accelerating selection and delivery. In this work we define traits characterizing salinity tolerance in rice and provide orientation for breeding a new generation of salt tolerant cultivars.

Materials and Methods

The rice model ORYZA v3 was modified to account for salinity on rice growth and yield (Radanielson et al., in press). Salt stress factors applied to water extraction, plant transpiration and assimilation rate were determined by parameters related to plant tolerance (Tol_coeff) and resilience (Res_coeff) to salinity and by soil electrical conductivity. The model was calibrated and validated with field experimental data using 3 contrasting rice varieties: BRRIDhan 47 (salt-tolerant), IR64 (moderately-tolerant) and IR29 (sensitive). Long-term scenario simulations were performed for Satkhira, Bangladesh using historical weather data (1980-2014) and virtual varieties characterized by different combinations of values, for Tol_coeff and Res_coeff, within the range of variation observed for the 3 varieties. Variance analyses of the model outputs were performed and general linear regression was used to estimate the contribution of Tol_coeff and Res_coeff to variation in yield.

Results and Discussion

ORYZA v3 model simulated rice yield variability under saline conditions with acceptable accuracy. This suggested that Tol_coeff and Res_coeff were able to represent the difference in tolerance among the studied genotypes and they were genotype specific. Yield responses to variations in Tol_coeff presented an increasing linear phase

followed by a plateau phase (Figure 1). The breaking point between these two phases corresponded to an optimum value of tolerance suitable to the prevailing salinity conditions. From this framework, an increase of 1 % in the salinity tolerance of IR64 would result in 0.3-0.4 % yield gain ($R^2=0.85-0.88$, $p<0.001$). A similar trend was observed with the resilience parameter (Res_coeff). The gain was about 0.07 % with an improvement of Res_coeff to a decrease of 1 % ($R^2= 0.85$, $p<0.001$, Figure 1). BRR1 Dhan47 presented a tolerance level suitable for saline conditions below 12 dS m^{-1} , as reported for its release (Islam et al., 2008). Improvement in BRR1-Dhan47 tolerance and resilience is likely an opportunity to develop newly cultivar adapted to conditions with higher salinity.

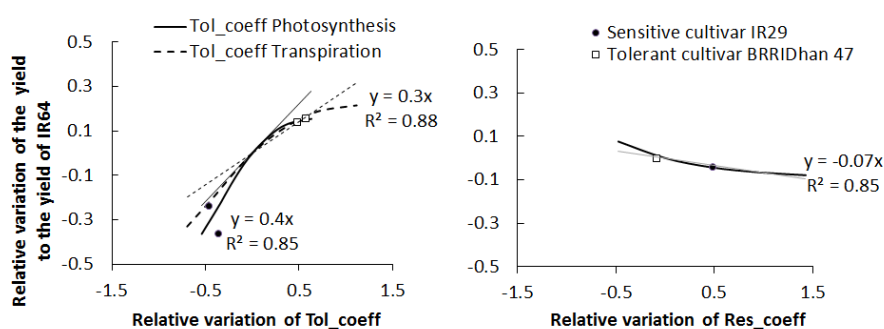

Figure 1. Change in yield relatively to the genotype of reference IR64 with variation of model parameter related to salinity trait (Tol_coeff & Res_coeff).

Conclusions

A trait-based modelling approach was used to represent the effect of salinity on rice crop performance. The salinity tolerance traits represented by the model parameters had genotypic variability and contributed significantly to the yield variability. A novel linear framework developed to quantify the effect of their variability on yield suggested new opportunities and directions to increase rice productivity in saline environments. Further studies in genetic variability of these model parameters would be of interest for breeding purposes and application.

Acknowledgements

The authors thank their collaborators from Bangladesh Agricultural Research Institute (BARI) helping in the data collection and the financial support from Global Rice Science Partnership (GRISP), Stress Tolerant Rice Varieties for Africa and South Asia (STRASA), and the Australian Centre for International Agricultural Research (ACIAR).

References

- Chenu, K., Cooper, M., Hammer G, et al., (2011). *Journal of Experimental Botany* 62, 1743-1755.
- Cooper, M., Podlich, D. W., and Smith, O. S. (2005). *Australian Journal of Agricultural Research* 56, 895-918.
- Deryng, D., W. J. Sacks, C.C. Barford et al., (2011). *Global Biogeochemistry Cycles* doi:10.1029/2009GB003765
- Islam, M.R., M.A. Salam, M.A.R. Bhuiyan et al., (2008). *Journal of Biological Research* 5, 1: 1-6
- Ismail, A.M., Heuer S., Thomson M.J. et al., (2007). *Plant Molecular Biology*. 65:547-70

Towards a genotypic adaptation strategy for Indian groundnut cultivation using model ensembles

J. Ramirez-Villegas^{1,2,3} – *A. J. Challinor*¹

¹ Institute for Climate and Atmospheric Science, School of Earth and Environment, University of Leeds, Leeds LS2 9JT, UK, E-mail: J.Ramirez-Villegas@leeds.ac.uk (JR-V); a.j.challinor@leeds.ac.uk (AJC)

² CGIAR Research Program on Climate Change, Agriculture and Food Security (CCAFS), Km 17 recta Cali-Palmira, Cali, Colombia

³ International Center for Tropical Agriculture, Km 17 Recta Cali-Palmira, Cali-Colombia

Introduction

Climate change has been projected to significantly affect agricultural productivity and hence food availability during the 21st century, with particularly negative effects across the global tropics (Challinor et al., 2014). Model-based projections of climate change impacts on crop productivity are critical for understanding cropping system responses under climate change scenarios so as to plan adaptation. In this study, the future productivity and potential benefits of genotypic adaptation were investigated for the groundnut crop in India using an ensemble of simulations. Specifically, we first assess the potential benefit from crop improvement by quantifying changes in mean and interannual variability of crop yields in hypothetical crop improvement scenarios with respect to no-adaptation scenarios; and secondly, we investigate robustness of future yield projections and quantify the relative importance of crop and climate uncertainties.

Materials and Methods

A crop model ensemble using the model GLAM (General Large Area Model for annual crops) was developed using observed yield data at the district-level and gridded observed weather data for areas with significant groundnut cropping in India (Challinor et al., 2004). The CMIP5 climate model ensemble was then bias corrected and used to simulate groundnut growth and development under present-day and future (2030s, RCP 4.5) conditions the parameter ensemble, without adaptation. Ensemble simulations were then used to quantify yield gains from crop improvement. Crop improvement scenarios focused on photosynthesis, water-use, partitioning and changes to phasic and whole-cycle durations. Using the ensemble of runs we finally assessed robustness (R) (Knutti and Sedláček, 2012), i.e. how large is the mean signal of change in comparison to the noise (i.e. uncertainty).

Results and Discussion

Improving partitioning to seeds (harvest index) was overall the most geographically consistent trait in its impact (Fig. 1). Mean yield gains of 20-40 % were observed in southern India, of 40-60 % in central, eastern and western India, and of up to 80 % in northern India. Improving photosynthetic rates (transpiration efficiency, maximum transpiration efficiency) proved to be less effective than improving partitioning; how-

ever, significant gains in southern and northern areas were achieved from improving this trait. The impact of enhanced maximum transpiration rate was large in northern and eastern India (generally above 60 %), but was less significant in the drier areas of the west and the warmer areas of the south. Changes in yield variability were much more geographically variable than those of mean yields, indicating that achieving temporal yield stability is a more challenging task. Importantly, we find that despite uncertainty, no-regret strategies are possible (high robustness in ~70 % growing area).

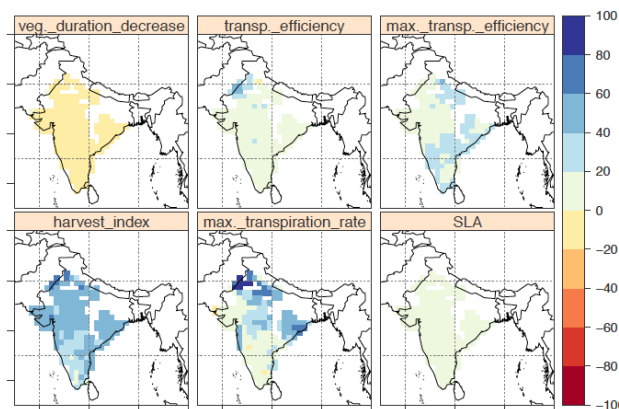

Figure 1. Projected mean yield changes by 2030s as a result of crop improvement related to drought scape and water use efficiency. Shown are the ensemble mean results for each of the genotypic properties. SLA=specific leaf area.

Conclusions

Uncertainty in actual values of yield was large, with almost equal contributions from climate and crop uncertainty, but in no case these uncertainties precluded a consistent and coherent simulation of genotypic adaptation. Our results suggest that partitioning to seeds should be a high priority trait in any breeding effort now so as to develop resilient germplasm that can be tested sufficiently early so as to be prepared for 2030 climates.

Acknowledgements

This study was funded by the CGIAR Research Program on Climate Change, Agriculture and Food Security (CCAFS).

References

- Challinor AJ, Wheeler TR, Craufurd PQ, Slingo JM, Grimes DIF (2004) Design and optimisation of a large-area process-based model for annual crops. *Agricultural and Forest Meteorology*, 124, 99–120.
- Challinor AJ, Watson J, Lobell DB, Howden SM, Smith DR, Chhetri N (2014) A meta-analysis of crop yield under climate change and adaptation. *Nature Climate Change*, 4, 287–291.
- Knutti R, Sedláček J (2012) Robustness and uncertainties in the new CMIP5 climate model projections. *Nature Climate Change*, 3, 369–373.

Field data based derivation of process descriptions in crop growth models. Is there still room for improvement?

A. M. Ratjen – H. Kage

Department of Agronomy and Crop Science, Institute of Crop Science and Plant Breeding, Faculty of Agricultural and Nutritional Sciences, Christian-Albrechts-Universität zu Kiel, Hermann-Rodewald-Str. 9; D-24118 Kiel Germany, ratjen@pflanzenbau.uni-kiel.de

Introduction

Mechanistic crop models aim to give a mathematical description of processes on the field, crop and organ scale. They include knowledge about causative relationships between important state variables of the crop-soil-environment system. This offers a potential advantage over statistical models, when it comes to extrapolations beyond the observed conditions. However, if the calibration process is based on yield observations only, underlying mechanisms of yield formation can become unrealistic and incoherent (Palosuo et al., 2011). At the crop and organs scale, functional relationships can often be derived directly or indirectly from experimental data. Here we discuss the value of field measurements for deriving crop specific process descriptions, using the example of specific leaf area (SLA). The SLA concept is often employed for simulation of leaf growth as a function of leaf dry matter accumulation. However, SLA simulation is still controversial: it is often assumed to be constant or a function of phenological development (e.g. Asseng et al., 2003). We investigated the explanatory power of phenological stages (BBCH) and leaf area index (LAI) on SLA of wheat and maize under varying N supply.

Materials and Methods

Previously published data of winter wheat and maize (wheat: Ratjen and Kage, 2013, maize: Wienforth, 2011) with different cultivars (maize: Ronaldinio, Salgado; wheat: Cubus, Ritmo, Tommi, Dekan), containing observations on BBCH, destructive leaf area measurements, shoot dry matter and shoot nitrogen (N) concentrations of different N treatments were used. The N nutrition status is indicated by the N nutrition index (NNI). For maize we used a negative power function with two plateaus, in order to describe the relation between SLA and explanatory variables (BBCH, LAI). For wheat linear relationships were used for the time before and after stem elongation phase. The used terms depend on the observed pattern.

Results and Discussion

All coefficients of the regression models were found to be significant ($P < 0.05$), but relationships differ between crops. This clearly shows that the assumptions of a constant SLA seems to be not appropriate for maize and wheat. LAI tends to have a greater explanatory power compared to BBCH (RMSE values of Figure 1). The often assumed decrease of SLA (e.g. Asseng, 2003) is only true for maize, while for wheat SLA is posi-

tively correlated with BBCH and LAI (at least after one node stage). This is probably caused by shading effects within the canopy (Ratjen and Kage, 2013). The example also illustrates the limits of template models: a uniform term for both crops would not fit well with observations and can be seen as a structural deficit.

Conclusion

If models with such structural deficits are fitted to yield observations, this inevitably causes compensating errors at other important processes. This in turn reduces the model accuracy for situations beyond the observed conditions. In order to enhance the predictive performance of crop models, mechanistic descriptions of processes on different hierarchy levels have to be improved (Ratjen and Kage 2015).

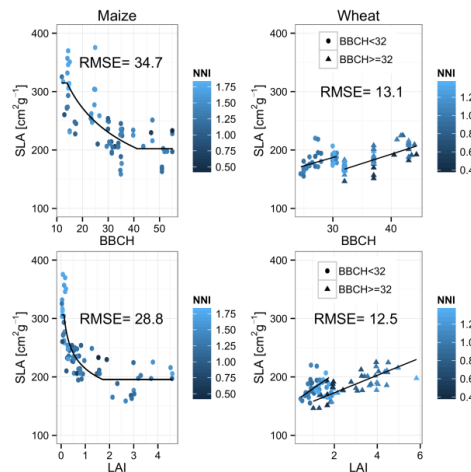

Figure 1: Impact of BBCH and LAI on SLA of maize and wheat.

The results also illustrate that experimental field data can help to detect relevant discrepancy concerning key processes of crop simulators. Thus, model development and calibration of important functional relationships should be as close as possible to the observed pattern.

References

- Angulo, C., Rötter, R., et al., (2013). Implication of crop model calibration strategies for assessing regional impacts of climate change in Europe. *Agric. For. Meteorol.* 170, 32 – 46.
- Asseng, S., Turner, N.C., Botwright, T., Condon, A.G. (2003). Evaluating the Impact of a Trait for Increased Specific Leaf Area on Wheat Yields Using a Crop Simulation Model. *Agron J* 95, 10–19.
- Palosuo, T. et al., (2011). Simulation of winter wheat yield and its variability in different climates of Europe: A comparison of eight crop growth models. *Eur. J. Agron.* 35, 103–114.
- Ratjen, A.M., Kage, H. 2015. Forecasting yield via reference- and scenario calculations. *Comput. Electron. Agric.* 114, 212 – 220.
- Ratjen, A.M., Kage, H. 2013. Is mutual shading a decisive factor for differences in overall canopy specific leaf area of winter wheat crops? *Field Crops Res.* 149, 338–346.
- Wienforth B. (2011): Cropping systems for biomethaneproduction: a simulation based analysis of yield, yield potential and resource use efficiency. Dissertation. CAU-Kiel.

Assessing uncertainty in bio-economic farm models: the importance of simulated crop yield and price changes on farm plans and gross margins

P. Reidsma¹ – Y. Tsutsumi¹ – A. Kanellopoulos²

¹ Plant Production Systems, Wageningen University, P.O.Box 430, 6700 AK Wageningen, The Netherlands, Pytrik.reidsma@wur.nl

² Operation Research and Logistics, Wageningen University

Introduction

Bio-economic farm models (BEFMs) can be used to assess the impact of climate change and associated socio-economic scenarios on farming systems. While model comparisons have been performed for uncertainty analyses of crop models (Asseng et al., 2013) and market models (Nelson et al., 2014), this has not been done so far for BEFMs. In this study, we compared two applications of the Farm System SIMulator (FSSIM), a BEFM, that assessed the impact of climate change and associated socio-economic scenarios on arable farming in Flevoland in the Netherlands in 2050 (Kanellopoulos et al., 2014; Wolf et al., 2015). Although both studies used FSSIM for the same research aim, many factors were different: climate and socio-economic scenarios, crop and market models that simulated the yield and price changes based on these scenarios, and factors related to the 'modelling framework': objective function, activities, farm types, data sources, and constraints. The relative influence of all these factors on farm plans and farm performance has been analysed.

Materials and Methods

To understand the sources of uncertainty, we first compared the FSSIM input and output between Kanellopoulos et al., (2014) and Wolf et al., (2015). Second, the yield and price changes of Kanellopoulos et al., (2014; by WOFOST and CAPRI) were applied to the modelling framework of Wolf et al., (2015; by SIMPLACE and adapted CAPRI version) and vice versa. Third, the resource constraints of FSSIM were altered to evaluate the influence of farm resources on FSSIM output.

Results and Discussion

In order to distinguish the effects of crop yield changes due to climate and technology changes (CT) and additional price changes (P), scatter plots were drawn for Percentage Absolute Deviation (PAD) of farm plans (Fig. 1a) and for the relative change in gross margin (Fig. 1b). In the Kanellopoulos et al., (2014) modelling framework, the effects of CT were smaller than that of P (Fig. 1a). On the other hand, in the Wolf et al., (2015) modelling framework, the effects of CT were larger than that of P except for B2G(+). Because the yield and price changes of B2G(+) were from Kanellopoulos et al., (2014), using different crop and market models had effects on FSSIM outputs. This can also be seen in the Kanellopoulos et al., (2014) simulations, where results for A1 and B2 sce-

narios were closer together when based on Wolf et al., (2015) changes (B2, A1-b1). In general, the effect of the modelling framework was larger however. Regarding the gross margin, the effects of CT were larger than P for all cases in the Wolf et al., (2015) modelling framework and A1W(+) in the Kanellopoulos et al., (2014) framework (Fig. 1b). This was opposite for the other scenarios by the Kanellopoulos et al., (2014) modelling framework. For gross margin changes, the input of yield and price changes was at least as important as the modelling framework.

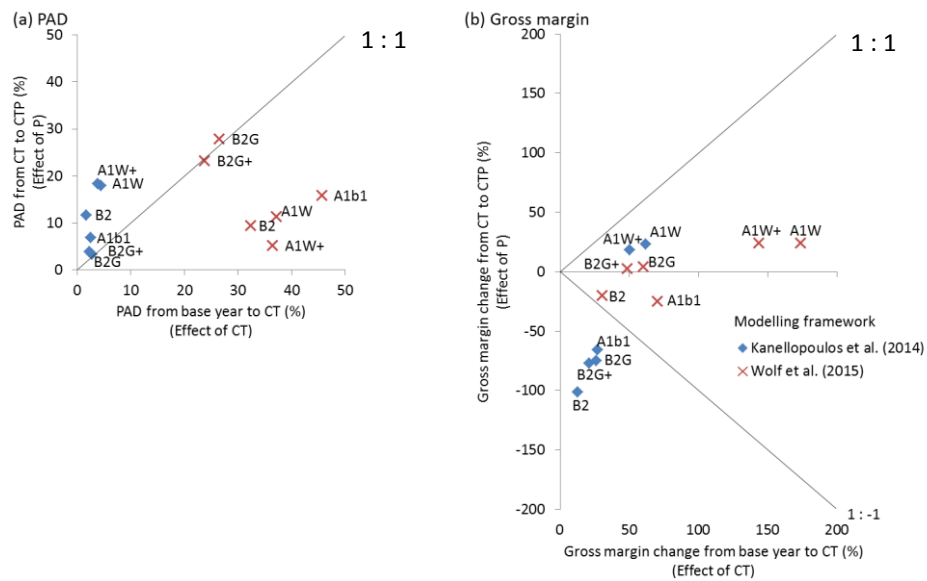

Figure 1. The effects of crop yield changes (CT) and additional price changes (P) on farm plans (a) and gross margin (b) in 2050. The x-axis shows the changes from the base year to CT and y-axis shows the changes from CT to CTP. The diamonds relate to the modelling framework of Kanellopoulos et al., (2014), the crosses of Wolf et al., (2015) respectively. B2G(+) and A1W(+) indicate yield and price changes of Kanellopoulos et al., (2014), B2 and A1b1 indicate the yield and price changes of Wolf et al., (2015) respectively.

Conclusions

In general, we can conclude that for farm plans, the impact of modelling framework was larger than the impact of yield and price changes. For gross margin changes, the impact of yield and price changes is at least as important.

References

- Asseng, S., et al., (2013). Nature Climate Change, 3: 827-832.
 Kanellopoulos, A., et al., (2014). European Journal of Agronomy, 52: 69-80.
 Nelson, G.C. et al., (2014). Proceedings of the National Academy of Sciences of the United States of America, 111: 3274-3279.
 Wolf, J., et al., (2015). Agricultural Systems, 140: 56-73.

The AgMIP coordinated climate crop modeling project (C3MP) – uncertainty in climate response across 1100+ crop modeling sets

A. C. Ruane^{1,2} – *S. P. Mcdermid*³ – *T. Mavromatis*⁴

¹ Climate Impacts Group, Research Scientist, NASA Goddard Institute for Space Studies, 2880 Broadway, New York, NY 10025, USA, alexander.c.ruane@nasa.gov

² Center for Climate Systems Research, Earth Institute, Columbia University, USA

³ Environmental Studies, Assistant Professor, New York University, USA

⁴ Department of Geology, Faculty Member, Aristotle University of Thessaloniki, Greece

Introduction

The ways in which crops respond to fundamental changes in carbon dioxide concentration ($[CO_2]$), temperature (ΔT), and precipitation (ΔP) hold the key to first order impacts of climate change on agricultural systems. Field and chamber experiments have allowed agronomists to observe the mechanisms by which crops are sensitive to these factors, however conducting these experiments across the tremendous diversity of worldwide farming systems is a daunting task despite the likelihood of non-linear interactions. A key aim of the Agricultural Model Intercomparison and Improvement Project (AgMIP; Rosenzweig et al., 2015) is to understand agricultural responses to climate changes, but it is also well understood that this response may vary across locations, crop models, crop species, cultivars, and management systems.

Materials and Methods

The AgMIP Coordinated Climate-Crop Modeling Project (C3MP; Ruane et al., 2014) enlisted crop modelers around the world to run a set of standardized carbon dioxide ($[CO_2]$), temperature, and rainfall change experiments their crop model configurations. More than 100 crop modelers participated, examining over 15 species and 20 crop models, with simulation sets in more than 50 countries (McDermid et al., 2015). Results from these simulation sets are now allowing for a large-scale examination of fundamental responses to climate change across the world's crop modeling sites, including ensemble mean responses formed via statistical crop model emulators as well differences in major response across the diverse agricultural systems simulated.

Results and Discussion

C3MP sites for maize, spring wheat, winter wheat, rice, soybeans, and peanuts provide the largest number of simulation sets and allow the most extensive evaluation. Ensemble mean responses reveal well-known features such as the lower response to elevated $[CO_2]$ in C4 crops as compared to C3, but also show fundamental differences in temperature response due in part to the geographical locations where certain crops are most prevalent (e.g., wheat tends to be grown in cooler climates than maize). The network of C3MP sites was not designed to be statistically representative of the world's agricultural production, however the voluntary network of C3MP sites is a

decent proxy for major production regions where crop models have been employed (and thus generally covers major agricultural areas). Uncertainty across simulation sets reveals heightened differences between simulation sets at extreme climate changes, particularly the high temperature conditions in which heat and water stress can be particularly damaging. Maize uncertainty is currently larger than that of the other crops, although this may be in part due to its large diversity of models and sites. C3MP results also reveal demonstrate a strong interaction between mean climate change and climate variability, resulting in larger extremes under future climate conditions.

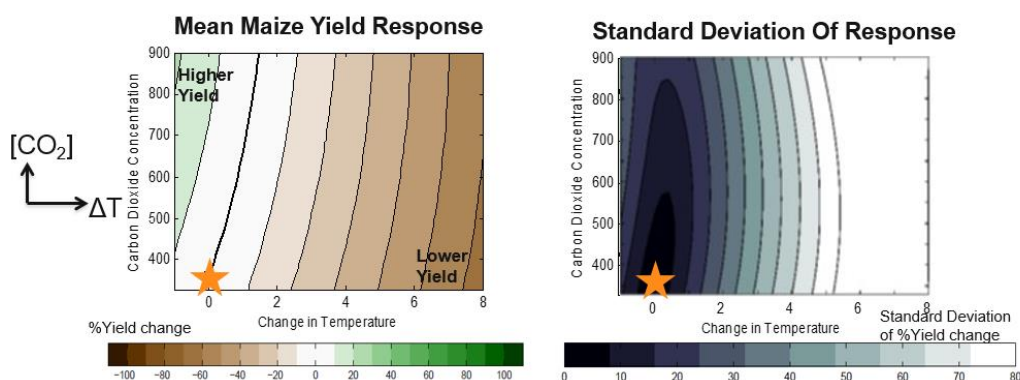

Figure 1. $[CO_2]$ and ΔT response of rainfed maize yield from 135 simulation sets contributed to C3MP. (left) mean yield response (as % of current climate mean yield); (right) standard deviation of mean yield response (as % of current climate mean yield) across all simulation sets. Star=current conditions.

Conclusions

C3MP results are shedding new light on diverse climate sensitivities and form a nice basis on which to compare across sites and modeling approaches.

Acknowledgements

This work is co-authored by the 100+ C3MP contributors around the world that made this study possible.

References

- McDermid, S.P., and co-authors (2015): The AgMIP Coordinated Climate-Crop Modeling Project (C3MP): Methods and protocols. In Handbook of Climate Change and Agroecosystems: The Agricultural Model Intercomparison and Improvement Project (AgMIP). C. Rosenzweig, and D. Hillel, Eds., ICP Series on Climate Change Impacts, Adaptation, and Mitigation Vol. 3. Imperial College Press, 191-220, doi:10.1142/9781783265640_0008.
- Rosenzweig, C., and co-authors (2013): The Agricultural Model Intercomparison and Improvement Project (AgMIP): Protocols and pilot studies. *Agr. Forest Meteorol.*, 170, 166-182, doi:10.1016/j.agrfor-met.2012.09.011.
- Ruane, A.C., an co-authors (2014): Carbon-temperature-water change analysis for peanut production under climate change: A prototype for the AgMIP Coordinated Climate-Crop Modeling Project (C3MP). *Global Change Biol.*, 20, no. 2, 394-407, doi:10.1111/gcb.12412.

An ensemble of projections of wheat adaptation to climate change in europe analyzed with impact response surfaces

*M. Ruiz-Ramos*¹ – *R. Ferrise*² – *A. Rodríguez*¹ – *I. J. Lorite*³ – *F. Tao*⁴ – *N. Pirttioja*⁵ – *S. Fronzek*⁵ – *T. Palosuo*⁴ – *T. R. Carter*⁵ – *M. Bindl*² – *J. G Höhn*⁴ – *K. C. Kersebaum*⁶ – *M. Trnka*^{7,8} – *H. Hoffmann*⁹ – *P. Baranowski*¹⁰ – *S. Buis*¹¹ – *D. Cammarano*¹² – *P. Deligios*¹³ – *P. Havlinka*^{7,8} – *J. Minet*¹⁴ – *M. Montesino*¹⁵ – *J. Porter*¹⁵ – *J. Recio*¹ – *F. Ruget*¹¹ – *A. Sanz*¹ – *Z. Steinmetz*¹⁶ – *P. Stratonovitch*¹⁷ – *I. Supit*¹⁸ – *D. Ventrella*¹⁹, *A. de Wit*¹⁶, *R. P. Rötter*⁴.

¹ Universidad Politecnica de Madrid, ETSIAgrónomos, 28040 Madrid, Spain, margarita.ruiz.ramos@upm.es

² University of Florence, 50144 Florence, Italy

³ IFAPA - Junta de Andalucía, 14004 Córdoba, Spain

⁴ Environmental Impacts Group, Natural Resources Institute (Luke), 01301 Vantaa, Finland

⁵ Finnish Environment Institute (SYKE), 00250 Helsinki, Finland

⁶ Leibniz Centre for Agricultural Landscape Research (ZALF), 15374 Müncheberg, Germany

⁷ Institute of Agrosystems and Bioclimatology, Mendel University in Brno, Brno 613 00, Czech Republic

⁸ Global Change Research Centre AS CR, 603 00 Brno, Czech Republic

⁹ INRES, University of Bonn, 53115 Bonn, Germany

¹⁰ Institute of Agrophysics Polish Academy of Sciences, Lublin, Poland

¹¹ INRA, UMR 1114 EMMAH, F-84914 Avignon, France

¹² James Hutton Institute, Invergowrie, Dundee, DD2 5DA, Scotland

¹³ University of Sassari, 07100 Sassari, Italy

¹⁴ Université de Liège, 4000 Liège, Belgium

¹⁵ University of Copenhagen, 2630 Taastrup, Denmark

¹⁶ RIFCON GmbH, 69493 Hirschberg, Germany

¹⁷ Rothamsted Research, Harpenden, Herts, AL5 2JQ, UK

¹⁸ Wageningen University, 6700AA Wageningen, The Netherlands

¹⁹ Consiglio per la ricerca in agricoltura e l'analisi dell'economia agraria (CREA-SCA), 70125 Bari, Italy

Introduction

Adaptation of crops to climate change (CC) requires reliable climate projections with low uncertainty at regional level. When these are not available, approaches can be used to manage the uncertainties involved, e.g. by exploring the potential changes in climate and their impacts. Here we use an ensemble of crop models applied to rainfed winter wheat at Lleida (NE Spain) and analyze the results by constructing impact response surfaces (IRSs).

Materials and Methods

The methodology is adapted from Pirttioja et al., (2015). The modelling experiment is a sensitivity analysis of an ensemble of crop models to changes in baseline (1981-2010) temperature (T) and precipitation (P), perturbed with a delta change approach and with changes in the seasonal patterns. Three levels of CO₂ are simulated, representing conditions until 2050. Two actual soil profiles of the Lleida site are considered. Crop models were calibrated with field data (Abeledo et al., 2008; Gabrielle et al., 2006). A pilot simulation stage conducted with the models DSSAT4.5 and SiriusQuality v.2

served as basis for selecting the adaptation options to be simulated by the whole ensemble of crop models (18 members and 11 models).

Results and Discussion

The specific adaptation options (Table 1) were identified based on the outcome from preliminary simulations. A total of 54 adaptation combinations were defined resulting in more than 450.000 runs per crop model.

Table 1. Adaptation options to be simulated by the ensemble of crop models.

Options	Vernalisation	Cycle length*	Sowing date	Irrigation
	Yes	+10 %	15 days earlier	40 mm at flowering
	No	-10 %	30 days later	Full irrigation
Number of options	1+baseline= 2	2+ baseline= 3	2+ baseline= 3	2+baseline= 3

*Maintaining pre-post-anthesis ratio

Maximum RMSE for calibrated variables was set at 20 %. The models were then considered trustworthy for reproducing crop development and growth and were used for constructing IRs. One example of preliminary results are presented in Figure 1, that shows how yield is affected by changes in T, P and CO₂ and that adaptation strategies may help to reduce detrimental effects of CC.

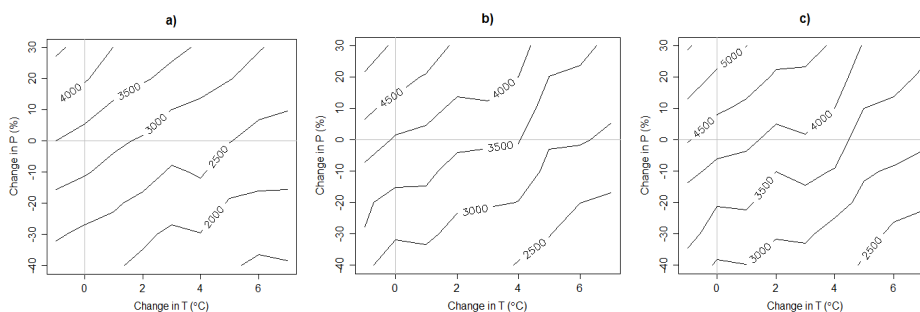

Figure 1. IRs for wheat yield in Lleida (kg/ha) built with SiriusQuality v.2 for a) baseline CO₂, cultivar and management, b) 447 ppm of CO₂ and 1-month delay in sowing date, and c) as b) but for 522 ppm of CO₂

Conclusions

Our study exemplifies the challenge of conducting adaptation under highly uncertain future conditions, attributable here to the high natural climate variability, the complex topography, the water-limited environment and the limited set of available field data.

Acknowledgements

Work was supported by MACSUR-, FACCE JPI, and by MULCLIVAR, from MINECO (CGL2012-38923-C02-02).

References

- Abeledo, L.G., R. Savin and G.A. Slafer (2008). European Journal of Agronomy 28:541-550.
- Cartelle, J., A. Pedró, R. Savin, G.A. Slafer (2006) European Journal of Agronomy 25:365-371.
- Pirttioja, N., T.R. Carter, S. Fronzek, et al., (2015). Climate Research, in press.

Use of remote sensing data to determine stress factors for the SALLUS model

U. Schulthess¹ – Z. U. Ahmed² – J. T. Ritchie³

¹ CIMMYT Bangladesh, House 10/B, Road 53, Gulshan 2, Dhaka 1212, e-mail: u.schulthess@cgiar.org

² CIMMYT Bangladesh, House 10/B, Road 53, Gulshan 2, Dhaka 1212, e-mail: z.ahmed@cgiar.org

³ Professor Emeritus, Homer Nowlin Chair, Michigan State University, East Lansing, MI 48823, e-mail: ritche@msu.edu

Introduction

Remote sensing has the potential to greatly enhance the capabilities of models to accurately simulate processes at the landscape level. Data acquired with optical sensors can be used to estimate the amount of light that is being intercepted by a crop. However, when it comes to quantifying stress levels, the potential of remote sensing data still has not been fully exploited. So far, water stress detection with thermal data is probably the most advanced solution. But its limitation is that it requires clear skies and needs to be measured in the early afternoon. Several other stress indices have been developed, such as the red-edge band based chlorophyll indices, fluorescence, as well as the photochemical reflection index (PRI). But so far, they are not absolute and have therefore not been directly linked to the models. In this work, we are proposing a new method to absolutely quantify the effects of stress on growth of maize with the use of the SALUS crop simulation model.

Materials and Methods

We planted the maize hybrid MK40 at three locations in the delta region of Bangladesh during the winter 2014/15. Elevation is around 3 m.a.s.l. Moderate soil and irrigation water salinity levels of around 5 dS/m were observed at one site, while salinity levels were low at the other 2 sites. The experiments were conducted on farmer's fields and plot sizes measured up to 25 by 30 m. We observed canopy development at a 2-3 week interval with an unmanned aerial vehicle, on which we could alternatively mount a RGB, multi-spectral or a thermal camera. During each flight day, we took simultaneous measurements of canopy temperature, and measured light absorption and leaf area index (LAI) with a SunScan and we also took RGB photos with a smart phone in order to calculate ground cover with the CanEye software. Shortly after silking, we also measured the length and width of each leaf of 20 plants from 2 sampling areas from each plot. That allowed us to calculate leaf size distribution. Together with monitored data on leaf appearance, we could determine when exactly each leaf appeared. With the combined use of the SALUS crop simulation model, which allowed us to calculate the amount of light that was intercepted during the expansion phase of each leaf, we could then back-calculate the amount of stress each leaf was exposed to during that phase. This information was then related to stress indices mentioned in the introduction.

Results and Discussion

The use of remote sensing data allowed us to precisely determine the spatial variability of crop growth within the plots. We observed stress due to lack of water as well as elevated salinity. Moreover, the plants suffered from phosphorus deficiencies in the early growth stages, presumably due to immobilization in the surface soil layer due to low pH levels of around 5. This data set allowed us to test the suitability of the various stress factors mentioned in the introduction and test how to best integrate them into the model. The method is still being refined, but initial results are very promising.

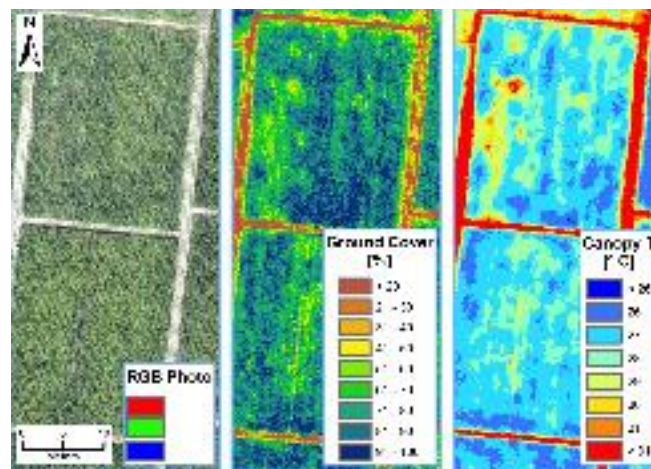

Figure 1. Example of the spatial variability within plots due to differences in stress levels.

Conclusions

This proposed method of the simultaneous use of a crop simulation model in conjunction with remote sensing derived stress indices shows big promise to absolutely quantify stress levels with remote sensing.

Acknowledgements

This study was supported by a grant from the Bill & Melinda Gates Foundation.

References

- Basso B. and Ritchie J. T. (2015). Simulating crop growth and biogeochemical fluxes in response to land management using the SALUS model *The Ecology of Agricultural Landscapes: Long-term Research on the Path to Sustainability* ed S K Hamilton et al (New York: Oxford University Press) pp 252–74 .

Designing wheat ideotypes for a changing climate

M. A. Semenov – P. Stratonovitch

Computational and Systems Biology Department, Rothamsted Research, Harpenden, Herts, AL5 2JQ, UK
e-mail: mikhail.semenov@rothamsted.ac.uk

Introduction

Increasing yield potential for major cereals is needed to meet the projected increased demand for world food supply of about 70 % by 2050. Considering the limitations on expanding crop-growing areas in Europe, a significant increase in crop productivity will be needed. Climate change is characterised by shifts in weather patterns, increases in climatic variability and extremes and, therefore, represents a considerable challenge to achieving the 70 % increase target. New wheat cultivars with an optimal combination of traits for future climatic conditions will be required. However, the inherent uncertainty of climate predictions presents a challenge to breeders who have limited time and resources and must select the most appropriate traits for improvement. Modelling provides a rational framework to design and test *in silico* new wheat ideotypes optimised for target environments and future climatic conditions (Hammer et al., 2006).

Materials and Methods

We used Sirius, a crop simulation model, to design wheat ideotypes optimised for future climate projections for two global climate models (GSMs) with contrasting climate sensitivity, HadGEM and GISS, and two emission scenarios, RCP4.5 and RCP8.5. This allowed us to optimise wheat ideotypes for four future scenarios that captured the uncertainty within the CMIP5 ensemble. We selected two contrasting sites in Europe, Rothamsted, UK (RR) and Seville, Spain (SL). A wheat ideotype was described by nine cultivar parameters of Sirius identified as most promising for improvement of yield potential under climate change (Semenov and Stratonovitch 2015). We used an evolutionary algorithm with self-adaptation to optimise these parameters for future climatic conditions. One hundred years of local-scale CMIP5-based climate scenarios, used in ideotype optimization, were generated by the LARS-WG weather generator.

Results and Discussion

Our analysis showed that wheat yield can be substantially increased for ideotypes compared with current wheat cultivars by selecting an optimal combination of wheat traits (Semenov et al., 2014). The main factors contributing to yield increase were improvement in light conversion efficiency, extended duration of grain filling and optimal phenology. Fig 1 shows simulated mean yields for ideotypes optimised for 2050 climate scenarios and the uncertainty in predictions related to the choice of GCMs (1A), or the use of different RCPs (1B).

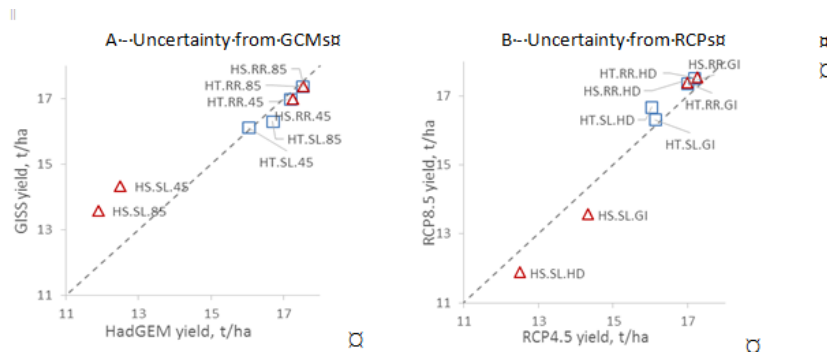

Figure 1. Mean yields for ideotypes, heat-tolerant (HT) or heat-sensitive (HS), optimised for future 2050 climates at two sites, RR and SL: (A) HadGEM vs GISS yields; (B) RCP4.5 vs RCP8.5 yields (Stratonovitch and Semenov 2015).

Wheat phenology must be tailored to specific climate scenarios to achieve maximum yield potentials; however, optimal phenological parameters for the 2050s cannot be specified at present. A prudent breeding strategy would be to keep sufficient genetic diversity to be able to adapt wheat development to a changing climate. There are some wheat traits which can improve yield potential regardless of a climate scenario selected. One of them is extended duration of grain filling, which results in an increased harvest index. This is only possible if both “sink” and “source” capacities are increased by improving the floret survival rate and maintaining healthy leaf area until the end of grain filling. In water-limited environments, improvement in drought tolerance, which delays leaf senescence, could be essential. Our simulation showed that with global warming the lack of heat tolerance around flowering could impose serious limitations on wheat yields in Southern Europe (Fig. 1) (Stratonovitch and Semenov 2015).

Conclusions

We described a computational framework based on a crop model for rational design of wheat ideotypes optimised for future climates in Europe. Despite large uncertainty in climate projections from GCMs and emission scenarios in the CMIP5 ensemble, we were able to identify target traits which may assist breeding for high-yielding cultivars.

Acknowledgements

We acknowledge support from an international research project “FACCE MACSUR”. Rothamsted Research is supported via the 20:20 Wheat by BBSRC, UK

References

- Hammer G, Cooper M, Tardieu F, et al (2006) Trends in Plant Science 11:587-593
- Semenov MA, Stratonovitch P (2015) Climate Research, 10.3354/cr01297
- Semenov MA, Stratonovitch P, Alghabari F, Gooding MJ (2014) J Cereal Science 59:245-256
- Stratonovitch P, Semenov MA (2015) J Exp Botany 66:3599-3609

Sugarcane yield gap in Brazil: Magnitude, causes and strategies to its mitigation

P. C. Sentelhas^{1,2} – *L. A. Monteiro*¹

¹ Department of Biosystems Engineering, ESALQ, University of São Paulo, Piracicaba, SP, Brazil.

² E-mail: pcsentel.esalq@usp.br

Introduction

The current sugarcane yields are still far from the country's potentiality, which has compromised the sustainability of the entire production chain of this crop. Such scenario is requiring the use of suitable methods for improving the efficiency of this crop, by identifying the main causes of yield gaps (YG). YG is the difference between potential (Y_p) and actual (Y_{avg}) yields (Lobell et al., 2009; Sentelhas et al., 2015). Thus, the objectives of this study were to identify the main causes of yield gap in Brazilian sugarcane and suggest management actions to its mitigation.

Materials and Methods

The potential (Y_p) and best farmer's (Y_{bf}) yields were determined by a properly yield model based on the Doorenbos & Kassam (1979) approach, considering 12 sugarcane fields conducted under high technology in Brazil. The weather inputs were taken by NASA/POWER system, but rainfall was replaced by the locally stations. The actual (Y_{avg}) sugarcane records were taken from IBGE (2014). The total yield gap ($Y_{G_{total}}$) was determined by the difference between Y_p and actual (Y_{avg}) yields. The $Y_{G_{total}}$ fraction caused by water deficit was calculated by the difference between Y_p and Y_{bf} , while the YG caused by deficiencies in crop management ($Y_{G_{CM}}$) was calculated by the difference between Y_{bf} and Y_{avg} .

Results and Discussion

The yield gap in Brazil varied substantially among regions and in each region. In the majority of the states the water deficit is the main cause of YG. The total sugarcane yield gap ($Y_{G_{total}}$) was, on average, 133.2 Mg ha^{-1} , in which 75.6 % ($\sim 101 \text{ Mg ha}^{-1}$) of yield losses is due to water deficit, while 24.4 % ($\sim 32 \text{ Mg ha}^{-1}$) is due to sub-optimal crop management practices, such as soil fertilization, pests, diseases and weeds control, planting failure, soil compaction, among others. In traditional sugarcane regions (Southeast), the $Y_{G_{total}}$ is 103 Mg ha^{-1} , being 78 % due water deficit and only 22 % by crop management. On the other hand, expanding regions as Northeast, the $Y_{G_{total}}$ was $\sim 167 \text{ Mg ha}^{-1}$, in which the water deficit was responsible by 86 % (143 Mg ha^{-1}) while crop management corresponded by only 14 % of yield losses. Below are presented the sugarcane yield gap maps due to water deficit ($Y_{G_{WD}}$, Figure 1a), to crop management ($Y_{G_{CM}}$, Figure 1b) and the total yield gap ($Y_{G_{total}}$, Figure 1c).

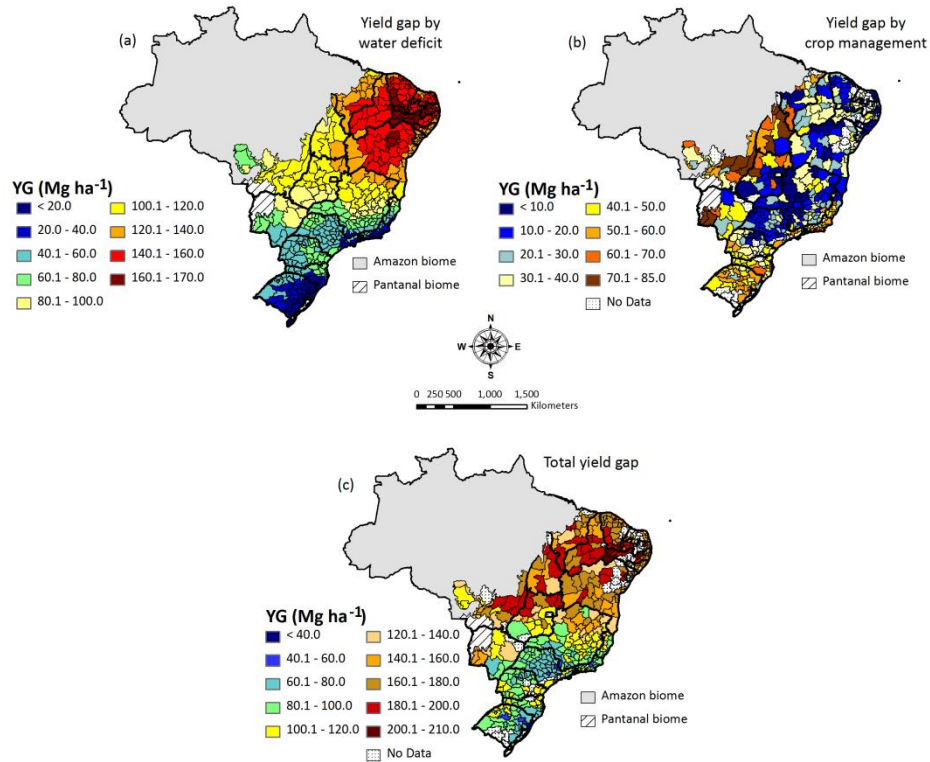

Figure 1. Spatial variability of sugarcane average (a) potential, (b) best farmer's and (c) actual yield.

Conclusions

The sugarcane yield gaps obtained in this study were properly determined in all regions evaluated. It allows to define better strategies to improve the sugarcane yield levels in Brazil, such as irrigation, use of drought tolerant cultivars and soil decompaction caused by extensive machinery traffic in the fields.

References

- Doorenbos, K. and A.M. Kassam (1979). Irrigation and Drainage Paper n° 33, 300 pp.
- David B. Lobell, D.B., K.G. Cassman and C.B. Field (2009). Annual Review of Environmental Resources. 34:179-204
- Sentelhas, P.C., R.Battisti, G.M.S. Câmara et al., (2015). Journal of Agriculture Science, Online, <http://dx.doi.org/10.1017/S0021859615000313>.

Sugarcane genetic trait parameter estimation

A. Singels – N. Hoffman – A. Paraskevopoulos – S. Ramburan

South African Sugarcane Research Institute, Private Bag X02, Mont Edgecombe 4300, South Africa.
e-mail: abraham.singels@sugar.org.za

Introduction

Crop models have the potential to enhance breeding programs but require accurate quantification of appropriately defined genetic trait parameters. Parameter values can be determined through direct measurement or indirectly from experimental data and observations. The objective of this study was to assess whether genetic trait parameter values derived from experimental data and subjective observations can predict genotype performance in different environments in South Africa.

Methods

Eight varieties were selected for this study (Table 1). The traits investigated were canopy development rate (quantified by TT50 – the thermal time required to reach 50 % canopy cover), onset of stalk growth (quantified by TTsg – the thermal time required from shoot emergence to onset of stalk growth) and maximum photosynthetic efficiency (RUEo, defined as gross photosynthate produced per unit of shortwave radiation intercepted under ideal conditions) and drought sensitivity (quantified as Estress - the relative available soil water threshold at the reference atmospheric demand of 5 mm/d, below which transpiration is reduced below the potential rate).

Parameter values for the reference variety NCo376 was determined by obtaining good fits of simulated to observed data of canopy cover, aerial dry mass ($R^2=0.93^{**}$, $n=40$) and stalk mass ($R^2=0.88^{**}$, $n=133$) (dataset described by Singels and Bezuidenhout, 2002). Parameter values for other varieties were estimated from experimental data and/or subjective expert ratings (SASRI variety information sheets) relative to that of NCo376. TT50 was determined from expert ratings of canopy formation. TTsg was calculated by assuming that stalks started growing when primary tillers carried ten fully expanded leaves, and was estimated from reference leaf appearance rate (LARo, defined as leaf appearance rate per unit thermal time) measured in a pot experiment at Mount Edgecombe. RUEo values were derived from leaf photosynthesis measurements (Licor 6400) in the same pot experiment. Pup5 values were derived from expert ratings of drought sensitivity.

The same eight varieties were grown under irrigation in Pongola (Nov 2011 to Nov 2012) and in rainfed conditions at Gingindlovu (Sep 2011 to Oct 2012) (Ngobese, 2015). Stalk dry mass (SDM) was determined from cane yield and stalk dry matter content measured at harvest.

Results and discussion

Parameter values and simulated and observed SDM are given in Table 1. Although the model systematically underestimated SDM (on average by 7 %) for Pongola, the simulated ranking of varieties correlated excellently with the observed ranking ($r=0.74^*$). The simulated range in SDM of 14 t/ha also compared well with the observed range of 10 t/ha ($LSD_{0.05}$ of observed SDM 6.0 t/ha). Observed and simulated SDM were best correlated with parameter RUEo (0.81^* and 0.99^*), followed by TTsg (-0.60 and -0.84^*).

The model also underestimated yields for Gingindlovu (on average by 22 %) and the simulated variety ranking was not correlated to the observed ranking. However, it should be noted these crops experienced severe drought conditions for eight out of 12 months and that observed yield differences were statistically insignificant ($LSD_{0.05}=4.9$ t/ha). Simulated yields for Gingindlovu was strongly correlated with RUEo (-0.99^*) and TTsg (-0.79^*), while observed yields were best correlated with TT50 (-0.73^*).

Table 1. Estimated parameter values and simulated and observed stalk dry mass (SDM) for eight sugarcane varieties grown at Pongola and Gingindlovu.

Variety	NCo376	N12	N19	N25	N31	N36	N41	N52
TT50 ($^{\circ}$ Cd)	250	340	220	250	220	220	280	220
TTsg ($^{\circ}$ Cd)	1000	1230	1050	950	1100	1050	950	1000
RUEo (g/MJ)	2.25	1.63	1.74	2.20	1.97	1.85	1.97	2.20
-Estress	0.45	0.45	0.55	0.5	0.35	0.5	0.35	0.5
Pongola (27 $^{\circ}$ 24'0"S; 31 $^{\circ}$ 35'0"E; 308 m)								
SDMsim (t/ha)	43.1	28.7	32.9	42.7	37.0	35.5	37.9	43.2
SDMobs (t/ha)	46.4	36.5	39.5	42.1	39.3	39.7	39.5	40.6
Gingindlovu (29 $^{\circ}$ 1'0"S; 31 $^{\circ}$ 36'0"E; 93 m)								
SDMsim (t/ha)	15.7	11.6	12.0	15.3	13.6	12.8	14.2	15.3
SDMobs (t/ha)	16.9	15.8	18.1	16.9	16.3	18.9	16.7	20.1

Conclusions

These preliminary results suggest that the model was able to simulate differences in variety performance in irrigated field trials through trait parameter estimations from independent experimental data and expert ratings. The validity of drought coping traits could not be assessed reliably. The approach followed here holds promise for determining trait parameter values for other genotypes with adequate data and information. Results also suggest that canopy development and photosynthetic efficiency hold the best promise for screening genotypes for irrigated environments in sugarcane breeding programs.

Acknowledgements

Model execution and data processing by Sanele Khambule is gratefully acknowledged.

References

- Singels, A. and Bezuidenhout, C.N. (2002). A new method of simulating dry matter partitioning in the Canegro sugarcane model. *Field Crops Research* 78: 151 – 164.
- Ngebese, I. (2015). Genetic coefficients of sugarcane phenology traits for crop model refinement. M.Sc. dissertation. University of the Free State, Bloemfontein.

Using crop model ensembles to design future climate-resilient barley cultivars

F. Tao^{1*} – *R. P. Rötter*¹ – *T. Palosuo*¹ – *C. G. Hernández*² – *M. I. Mínguez*² – *M. Semenov*³ – *K. C. Kersebaum*⁴ – *C. Nendel*⁴ – *D. Cammarano*⁵ – *H. Hoffmann*⁶ – *F. Ewert*⁶ – *A. Dambreville*^{7,8} – *P. Martre*^{7,8} – *L. Rodríguez*² – *M. Ruiz-Ramos*² – *T. Gaiser*⁶ – *J. G. Höhn*¹ – *R. Ferrise*⁹ – *M. Bindi*⁹ – *A. Schulman*¹⁰

¹ Environmental Impacts Group, Natural Resources Institute Finland (Luke), FIN-01301 Vantaa, Finland

² AgSystems–CEIGRAM Research Centre for Agricultural and Environmental Risk Management (CEIGRAM)- Technical University of Madrid, Spain

³ Computational and Systems Biology Department, Rothamsted Research, Harpenden, Herts AL5 2JQ, UK

⁴ Institute of Landscape Systems Analysis, Leibniz Centre for Agricultural Landscape Research, 15374 Müncheberg, DE

⁵ The James Hutton Institute, Invergowrie Dundee DD2 5DA, Scotland, UK

⁶ Crop Science Group, INRES, University of Bonn, Katzenburgweg 5, 53115 Bonn, DE

⁷ INRA, UMR795 Laboratoire des Plantes sous Stress Environnementaux, F-34 060 Montpellier, France

⁸ Montpellier SupAgro, UMR795 Laboratoire des Plantes sous Stress Environnementaux, F-34 060 Montpellier, France

⁹ Department of Agri-food Production and Environmental Sciences - University of Florence, Piazzale delle Cascine 18, 50144 Firenze, IT

¹⁰ Green Technology, Natural Resources Institute Finland (Luke), and University of Helsinki, FIN-0014 Helsinki, Finland

* Correspondence: Email: fulu.tao@luke.fi

Introduction

The global demand for agricultural crop production is expected to roughly double by 2050. However, yields for important crops are stagnating in several important agricultural regions around the world due to changes in climate and agronomic management. Cultivar development and improved agronomic practices are a center piece of climate change adaptation in agriculture. Process-based crop models developed for simulating interactions between genotype, environment and management are widely applied to assess impacts of environmental change on crop development and growth, grain yield formation and resources. During recent decades, crop simulation has become an important tool for supporting plant breeding, in particular in the design of ideotypes, i.e. “model plants”, for different crops and cultivation environments (Rötter et al., 2015). Our study aims to: (i) examine the main limitations of crop simulation modelling for ideotype breeding, (ii) present a new approach developed in MACSUR (<http://macsur.eu/>) Barley Cultivar Design (BCD) study, and (iii) present results on model-aided ideotyping of climate-resilient barley cultivars for Boreal and Mediterranean climatic zones.

Material and Methods

In the BCD study, an ensemble of eight crop models (i.e. APSIM 7.5, CropSyst 3.02, HERMES 4.26, MCWLA 2.0, MONICA 1.2.5, SIMPLACE, SiriusQuality 2.0 and WOFOST 7.1)-representing different degrees of complexity and different strengths - was used for identifying promising ideotypes and address model uncertainties. These models were driven by three climate projections of the emission scenario RCP 8.5 for the period of 2050s

obtained using the HadGEM, GISS and ACCESS global circulation models of the CMIP5 ensemble. The projections served as an example of a future with high greenhouse gas emissions. An orthogonal sampling approach was used in crop model genetic parameters perturbations to ensure good representation of parameters variability. Crop models simulations were conducted for baseline climate (1981-2010) and for three different projected climates for 2050s using perturbed parameter sets. The simulations producing high grain yields and low variability were identified and the corresponding crop cultivars genetic parameters sets were further investigated to identify desirable traits.

Results and Discussion

The results showed that some genotype (represented by a set of genotypic parameters in crop model) are promising under future climate change conditions, resulting in high yielding and low variability, however some could lose yields substantially (Fig.1). Furthermore, traits such as long reproductive growing period, 'staying green', high light use efficiency or photosynthesis rate, drought- and heatresistance are desirable under future climate conditions, which can produce substantially positive impacts on yields under contrasting conditions. However, some traits such as crop development rate during vegetative growth stage and maximum leaf area index had different impacts on crop yields under different climate conditions. The favorable ideotype was further proposed with combinations of several key genetic traits.

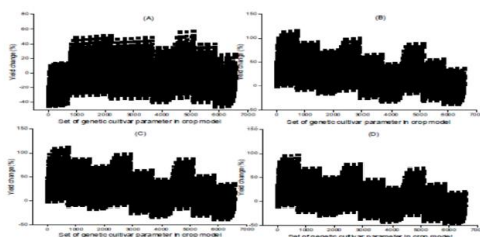

Figure 1. Simulated yield change during 1981 - 2010 (A), and during 2050s under ACCESS (B), GISS (C) and HadGEM (D) climate change scenario using perturbed crop genetic cultivar parameter sets, relative to the simulations using one representative cultivar during 1981 - 2010, talking MCWLA model as an example.

Conclusions

The study suggests that process-based crop models should be an important tool for supporting crop breeding. Combining conventional crop simulation with genetic modelling promises to accelerate delivery of future cereal cultivars for different environments. Robustness of model-aided ideotype design can further be enhanced through continuously improving simulation models to better capture effects of climate extremes and the use of multi-model ensembles.

Acknowledgements

This work received support and was jointly conducted by projects FACCE-MACSUR and AgMIP.

References

Rötter, RP, Tao F., Höhn JG, Palosuo, T. 2015. Use of crop simulation modelling to aid ideotype design of future cereal cultivars. Journal of Experimental Botany, doi:10.1093/jxb/erv098.

Uncertainty due to GENOTYPE and Management in wide-area maize simulations

*E. Teixeira*¹ – *G. Zhao*² – *J. de Ruiter*¹ – *H. Brown*¹ – *A.-G. Ausseil*³ – *E. Meenken*¹ – *F. Ewert*²

¹ Systems Modelling, Field Crops, The New Zealand Institute for Plant and Food Research Limited, Lincoln, Canterbury, New Zealand, e-mail: Edmar.teixeira@plantandfood.co.nz

² Crop Science Group, Institute of Crop Science and Resource Conservation (INRES), University of Bonn, Katzenburgweg 5, 53115 Bonn, Germany

³ Landcare Research, Private Bag 11052, Palmerston North, New Zealand

Introduction

When performing regional crop yield assessments, the knowledge about spatial variability of genotype (G) and management (M) practices is often unavailable or imperfect (Ewert et al., 2015). For example, wide-area maize simulations require information on the genotype maturity characteristics (i.e. G component) and sowing dates (i.e. M component). The extent by which this translates into uncertainty for biomass productivity estimates, under different environments (E), is unclear.

Materials and Methods

A modeling experiment was set up considering a factorial combination of 25 scenarios with 5 sowing dates (1-Sep to 1-Jan) and 5 hybrid types (short to long cycle duration maize hybrids) at 5 min spatial resolution across the arable lands in New Zealand. Total biomass for irrigated silage maize was simulated with the APSIM model (Holzworth et al., 2014) for 30 years (1971–2000). Averages and the coefficient of variation (CV) among the 25 scenarios were used to assess the sensitivity of results to G and M parameterization within 9 climate zones created by clustering analysis.

Results and Discussion

Total biomass estimates declined and the CV increased in climate zones (Figure 1) with less favorable growth conditions (Table 1). This is because early sowing dates and short-cycle hybrid combinations concentrated crop growth in early-spring, while late sowings and long-cycle hybrids delayed the grain filling period to late-autumn, when low temperatures and low radiation limit maize canopy expansion and carbon assimilation, particularly in the more southern regions of New Zealand.

Conclusions

The sensitivity of silage maize biomass to hybrids and sowing dates differed largely across climate zones. Uncertainty was greater when climatic conditions were marginal for crop growth. These results highlight the importance of methodological procedures to enhance spatially explicit knowledge on G and M parameterization in order to reduce uncertainty in wide-area crop simulations.

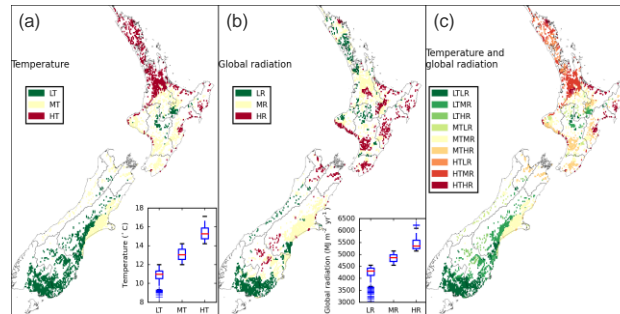

Figure 1. Clusters of temperature (T, σT) and global radiation (R, b) into 9 climate zones (c) considering high (H), medium (M) and low (L) 30-year values per grid-cell.

Table 1. Grid-cell count, average, coefficient of variation (CV) and percentile range (25th and 75th percentile) for total biomass pooled within each climate zone across 25 scenarios of 5 hybrid maturities and 5 sowing dates.

Climate Zone	Grid-cells (n)	Average (Mg DM/ha)	CV (%)
LTLR	480	15(13–18)	30(28–31)
LTMR	95	18(15–21)	26(23–27)
LTHR	122	20(18–24)	23(20–25)
MTLR	532	17(15–20)	21(20–23)
MTMR	354	20(18–23)	20(19–22)
MTHR	132	21(19–25)	18(17–19)
HTLR	305	17(15–19)	18(18–18)
HTMR	151	18(16–21)	17(17–17)
HTHR	480	21(19–24)	16(15–17)

Acknowledgements

This work was partially funded by the Climate Change Impacts and Implications for New Zealand project (CCII) financed by the Ministry of Business, Innovation and Employment (MBIE) of New Zealand. Gang Zhao was supported by the German Federal Ministry of Education and Research (BMBF) through the SPACES project “Living Landscapes Limpopo” and WASCAL (West African Science Service Center on Climate Change and Adapted Land Use) project.

References

- Ewert F., Rötter R.P., Bindi M., Webber H., Trnka M., Kersebaum K.C., ..., Asseng S. (2015) Crop modelling for integrated assessment of risk to food production from climate change. *Environmental Modelling & Software*, published online doi:10.1016/j.envsoft.2014.1012.1003.
- Holzworth D.P., Huth N.I., deVoil P.G., Zurcher E.J., Herrmann N.I., McLean G., ..., Keating B.A. (2014) APSIM – Evolution towards a new generation of agricultural systems simulation. *Environmental Modelling & Software* 62, 327-350.

**Balance the Trade-off between Food Security and GHG emission for
paddy field in China based on the coupling of DNDC,
DSSAT and AEZ models**

Z. Tian¹ – Y. Niu¹ – L. Sun^{2,3} – G. Fischer² – C. Li⁴

¹ Shanghai Climate Center, Shanghai Meteorological Bureau, Shanghai 200030, China

² International Institute for Applied System Analysis, Laxenburg A-2361, Austria

³ Department of Geographical Sciences, University of Maryland, College Park 20742, USA

⁴ Institute for the Study of Earth, Oceans, and Space, University of New Hampshire, Durham, NH 03824, USA

Introduction

China has promised to peak CO₂ emission by 2030 or earlier, which was announced in the China-U.S. Joint Statement on Climate Change on November 12, 2014. In China, agriculture is the second major source of GHG emission which includes CO₂, CH₄ and N₂O. The rising rate of CH₄ and N₂O emission is mainly driven by increased rice cultivation area and climate warming. On the other hand, paddy rice is one of the most important food crops to ensure food security in China. This indicates a tension between climate change mitigation and food security. How to balance the trade-off between food security and agricultural GHG emission reduction is an important issue to be addressed by scientists and decision-makers. Hence, it is necessary to find a scientific-based field-management approach to mitigate the GHG emission in paddy field without decreasing rice yield.

Materials and Methods

In this research, we employ three models to quantify the GHG emission in paddy field in China. We first use Denitrification-Decomposition(DNDC) model (Li, 2001) to simulate rice growing in China and to evaluate the non-CO₂ GHG emission. DNDC is a site-level biogeochemistry processed model and is capable of simulating C and N circulations in agricultural system, However, default cultivar parameters in DNDC cannot represent richness and regional diversity of cultivar parameters in the research area. To improve the ability of DNDC for regional scale GHG emission simulation, we further employ the Decision Support System for Agro-technology Transfer(DSSAT) model (Jones and Hoogenboom et al., 2003) and the Agro-Ecological Zone(AEZ) model (Fischer and van Velthuis et al., 2002) to generate several detailed cultivar parameters based on site-level observation data and establish more reliable upscaling method.

Results and Discussion

At the site level, fertilizer application in all nine stations is higher than actual crop requirement by a scale of 5 % to 35 %. If reducing the fertilizer application to the requirement level, the average N₂O emission could reduce by a scale of 9.76 % to 76.6 % in nine stations. At regional level, if reducing the fertilizer application to the

requirement level, N₂O emission will reduce significantly without decreasing yield. The average rice yield during 1981 to 2010 could hold well in most areas of China, with a range of decreasing ratio between 0 % and 4 %. By contrast, the range of N₂O emission decreasing ratio is between 4 % and 98 %, and the ratio is higher than 20 % in most areas. However, in some areas, such as northeast of China, rice yield will decrease by a larger margin, with the highest decreasing ratio of 13.5 %, although decreasing ratio of N₂O is higher than that.

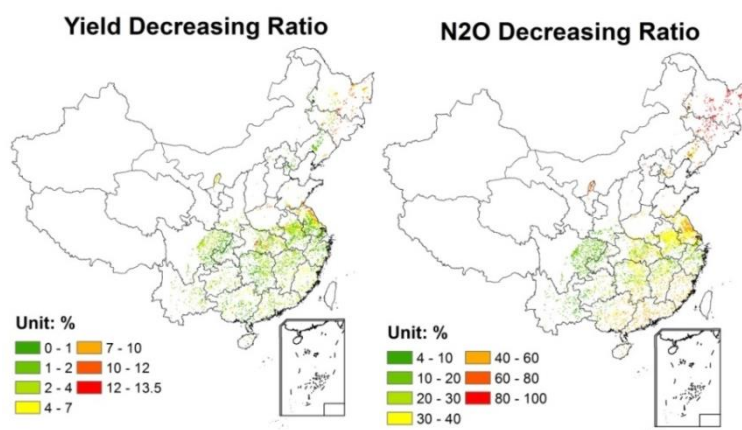

Figure 1. Simulation result at regional-level in 2000s. Left: yield. Right: N₂O emission.

Conclusions

- (1) The rice cultivar parameters in DNDC have been successfully improved via the site-level simulations of DSSAT based on field observations. Updated DNDC with the help of AEZ model can simulate rice growth accurately and properly in all nine stations and at the cropping-system-zone level.
- (2) Fertilizer application is excessive in all stations. Reduction of the application of nitrogenous fertilizer to the balanced level will significantly reduce N₂O emission without negative consequences on yield.
- (3) Reduction of the application of nitrogenous fertilizer to the balanced level is also a good approach to reduce regional N₂O emission without the cost of yield reduction except in the northeast region of China.

Acknowledgements

This research was jointly supported NSFC funding (NO. 41371110) and IIASA YSSP Program.

References

- Fischer G., van V et al., (2002). Global agro-ecological assessment for agriculture in the 21st century: Methodology and results. IIASA RR-02-02, Laxenburg, Austria.
- Jones, J. W., G. Hoogenboom, et al., (2003). The DSSAT cropping system model. *European Journal of Agronomy* 18(3-4): 235-265.
- Li C. (2001). Biogeochemical concepts and methodologies: development of the DNDC model. *Quaternary Sciences* 21(2): 89-99.

Assessment and comparison of leaf area modeling approaches for Maize

*D. Timlin*¹ – *S.-H. Kim*² – *K. Dzotsi*³ – *M. Tollenaar*⁴ – *S. Kumudin*⁴ – *H. Yang*⁵ –
*G. Maddonni*⁶ – *J. Lizaso*⁷ – *D. Fleisher*¹ – *F. Tardieu*⁸ – *A. Kemanian*⁹ – *B. Quebedeaux*¹⁰ –
*K. Boote*³ – *C. Stockle*¹¹

¹ USDA-ARS, Beltsville, MD, Dennis.Timlin@ars.usda.gov,

² University of Washington, Seattle, WA

³ Univ. of Florida, Gainesville, FL 32611.

⁴ Monsanto Corporation, Research Triangle Park, NC

⁵ Univ. of Nebraska, Lincoln, NE

⁶ Cátedra de Cerealicultura Fac. Agronomía. UBA

⁷ Fitotecnia, Technical Univ. Madrid, Spain.

⁸ INRA, Montpellier, France

⁹ Penn State Univ. State College, PA

¹⁰ Univ. of Maryland, College Park, MD

¹¹ Washington State Univ., Pullman, WA

Introduction

Crop models are being increasingly relied on to provide assessments of climate change impacts on future yields, primarily through temperature and water stress effects. It is therefore important to accurately estimate leaf area expansion and senescence, and their linkage to leaf ontogeny and phenology particularly when average temperatures are above the optimum. The purpose of this study is to compare different approaches to modeling leaf area in maize to assess their strengths and weaknesses, and identify areas where knowledge gaps exist

Materials and Methods

Here we investigated several maize models including, AgMaize (Dzotsi et al., 2015), Hybrid Maize (Haishun Yang, 2004), and MAZSIM (Kim et al., 2012) to assess leaf growth response to temperature and carbon. The model simulation results were compared to observed leaf area data from three locations, two having a range of plant densities. In addition, the models' responses to temperature and water were compared using 30 years of daily weather data generated by CLIM-Gen with average temperatures adjusted upwards by +3 and +6 C and precipitation adjusted downward by 20 %. The three models use similar approaches to model leaf addition rate and leaf expansion. However the methods of quantifying temperature are different.

In AgMaize and MAZSIM, a non-linear beta function is used to quantify the temperature responses of single leaf addition and expansion rates. Hybrid Maize uses growing degree days and simulates LAI as a function of temperature.

Results and Discussion

Generally there were not large differences in LAI among the models. Leaf area simulations for Hybrid Maize were higher than for the other two models. The individual leaf area calculations in AgMaize and Maizsim resulted in leaf areas closer to the measured values. Hybrid Maize, however was not calibrated for this data set.

AgMaize and MAIZSIM responded similarly to temperature where the LAI of both models decreased with increasing temperature (Table 1). This was partially due the shorter period of leaf growth resulting from shortened lifecycle (more rapid senescence) at increasing temperatures. Leaf addition and elongation rates were also slower at high temperatures in AgMaize and MAIZSIM. Hybrid Maize uses a GDD approach that does not decrease leaf addition and expansion processes at super-optimal temperatures. Hence for the Hybrid Maize simulations maximum LAIs were not decreased at temperatures above the normal records.

Table 1. Leaf area index simulated at normal and temperatures 3 and 6 °C higher than normal.

Treatment	LAI		
	Model		
	AgMaize	HybridMaize	MaizSim
Normal	3.9	5.1	3.9
Normal Avg +3	3.8	5.0	3.7
Normal Avg +6	3.4	5.0	3.4

Conclusions

Some calibration/fitting may be necessary to obtain optimal parameters for leaf area expansion for a particular variety. Size of largest leaf and location on the stem is one of the most critical variables. Non-linear temperature dependencies for leaf processes appear useful to simulate the effects of elevated temperatures on leaf addition and expansion. Suggestions for improvement of the models including potential dependency of leaf expansion on hydraulic processes in the leaf will be discussed.

Reference

- Dzotsi, K., T. Tollenaar, S. Kumudini, J.Lizaso. (2015). personal communication.
 Kim S-H, Yang Y, Timlin D, Fleisher D, Dathe A, Reddy VR, Staver K (2012) Modeling temperature responses of leaf growth, development, and biomass in maize with MAIZSIM. *Agronomy Journal* 104(6): 1523-1537.
 Yang HS, Dobermann A, Lindquist JL, Walters DT, Arkebauer TJ, Cassman KG. (2004). Hybrid maize—a maize simulation model that combines two crop modeling approaches. *Field Crops Res.* 87:131–54

Integrated crop-systems research: A trait-based breeding pipeline

Vadez¹ – Kholová¹ – Sivasakthi¹ – Thudi¹ – Hammer²

¹ International Crops Research Institute for the Semi-Arid Tropics, Patancheru, Telangana 502 324, India,

² The University of Queensland, QAAFI, Brisbane, Qld 4072, Australia

Introduction

Crop ideotypes achieving higher yield maximize plant water extraction and ensure water availability for the reproductive period (Vadez et al., 2013; Borrell et al., 2014). This depends on traits / trait response to environment controlling the plant water budget - canopy (Vadez et al., 2011; van Oosterom et al., 2011) and conductance (Kholova et al., 2010; Zaman-Allah et al., 2011).

Drought varies with time and geographical scales. Testing traits or trait/agronomic management combinations on crop performance across environments is needed but impractical, though it can be done with crop simulation tools (Sinclair et al., 2010; Kholova et al., 2014; Hammer et al., 2006; Vadez et al., 2012) to guide and justify the most promising breeding/management targets (Hammer et al., 2014).

The talk highlights case studies linking trait dissection, genetic analysis, and crop simulation prediction of value and risk probability in target environments.

Materials and Methods

Plant material

- Chickpea recombinant inbred lines (RILs) (232) segregating for water use traits
- Sorghum lines introgressed with staygreen QTLs
- Sorghum germplasm and parents of BCNAM populations

Trait dissection

- Transpiration rate (Tr) response to increasing vapor pressure deficit (VPD)
- Water transport pathways in roots – Aquaporin gene expression
- Canopy development dynamics either with destructive harvest from field trial, or 3D-laser scanning in the LeasyScan platform (Vadez et al., 2015)
- Timing of plant water extraction / transpiration efficiency (TE) (Vadez et al., 2014)

High throughput phenotyping and trait genetics

- Lysimeter setup (LysiField) for water budget, TE, and timing of water extraction
- LeasyScan laser scanning platform for leaf canopy development and transpiration
- QTL analysis using both QTL cartographer and GMM for analysis of loci interaction
- Assessment of genetic panels and populations

Analysis of trait/management effect with crop simulation

- APSIM and SSM (Simple Simulation Model) used as mechanistic models for C4 cereals and legume species, using daily weather observations, soil characteristics, genotype coefficients. They allow to classify the drought scenarios and predict the value of genetic trait or agronomic management alterations on crop productivity

Results and Discussion

Trait dissection - From water use traits to genes and gene expression

- Staygreen QTL altered the Tr response to high VPD and the canopy development, in a genetic background-dependent manner
- High TE related to transpiration (Tr) restriction under high VPD in sorghum
- Genotypes with Tr sensitivity to VPD had lower aquaporin gene expression
- Tr response to VPD reflected differences in water transport pathways in the root

Trait phenotyping and genetics - From water use traits to QTLs

- Genomic regions regulating Tr on LG4 and LG7 and canopy traits on LG4 were found
- Staygreen QTL sorghum introgression lines and germplasm showed large variation in the Tr response to VPD, with specific QTL contributing to specific traits
- BCNAM population parents varied for the Tr response to VPD

Trait simulation - From water use traits to yield assessment in target regions

- Both crop models reliably reproduced the observed water use dynamics and consequent yield gains of sorghum crop with limited Tr under terminal drought
- Simulations revealed potential sorghum production benefits/risks of altered Tr in target regions, and then highlighted promising breeding / agronomic packages
- Tr restriction led to major grain / stover yield benefit in water limited environment
- Increase sowing density led to major groundnut yield increases in West Africa

Conclusions

A pipeline of interdisciplinary capacities/tools/techniques to guide breeding and agronomic decisions was developed. Genetic regions underlying variation for traits controlling plant water use were identified. Tr restriction under high VPD showed an involvement of aquaporin genes. Model prediction of effect of the observed variability in Tr allowed mapping of potential production benefit *in silico*.

Acknowledgements

CGIAR Research Program (CRP) on Grain Legume, CRP-Dryland Cereals, ACIAR, B&MGF, USAID FTF Innovation lab on Resilient Sorghum

References

- Vadez, V., J. Kholova et al., (2013) – PLO DOI 10.1007/s11104-013-1706-0
- Borrell, A.K., E.J. van Oosterom, J.E. Mullet et al., (2014) – New Phytol. doi: 10.1111/nph.12869
- Vadez, V., S.P. Deshpande, J. Kholova et al., (2011) – Funct. Pl. Biol. 38, 553-566
- Van Oosterom, E.J., A.K. Borrell et al., (2011) - Crop Science 51: 2728–2740
- Kholova, J., C.T. Hash, P. Lava Kumar et al., (2010) - - J Exp Bot 61: 1431-1440
- Zaman-Allah, M., D. Jenkinson, V.Vadez (2011) – Funct. Pl. Biol. 38: 270-281
- Sinclair, T.R., C.D. Messina et al., (2010) – Ag. J. Agron. J. 102: 475–482
- Kholova, J., M. Tharanya, K. Sivasakhti et al., (2014) – FPB 41: 1019–1034
- Hammer, G.L., M. Cooper, F. Tardieu et al., (2006) - Trends Plant Science 11: 587–593
- Vadez, V. A. Soltani, T.R. Sinclair (2012) – Field Crop Res 137: 108-115
- Hammer, G.L., G. McLean, S. Chapman et al., (2014) – Crop Past. Sci. 65: 614-626
- Vadez, V., J. Kholova, G. Hummel et al., (2015) - J Exp Bot doi: 10.1093/jxb/erv251
- Vadez, V., J. Kholova, S. Medina et al., (2014) – J Exp Bot doi:10.1093/jxb/eru040

Crop responses to atmospheric CO₂ concentrations: diversity, parameterization and validation in crop models

*E. Vanuytrecht*¹ – *P. Thorburn*²

¹ Department Earth & Environmental Sciences, KU Leuven, Celestijnenlaan 200E, 3001 Heverlee, Belgium, eline.vanuytrecht@ees.kuleuven.be

² CSIRO Agriculture, Queensland BioScience Precinct, 306 Carmody Road, St Lucia Q 4067, Australia

Introduction

Crop models are extensively used to assess climate change impacts on crop production and food security. Nevertheless, there is no consensus on essential responses to CO₂ concentration ([CO₂]) among modellers. These response differences have recently been quantified in model intercomparison studies (Asseng et al., 2013; Bassu et al., 2014; Li et al., 2015). Next to that, lack of well-documented and centralized information and model validation (Rötter et al., 2011; White et al., 2011; Boote et al., 2013) obscures the legitimate use of the models. This study presents approaches and magnitudes of modelled CO₂ responses in various crop models, as well as their level of validation and application, and gives suggestions for a coordinated way-forward.

Materials and Methods

Modelling approaches, response magnitudes, parameterization and validation of crop responses to [CO₂] in different crop models are evaluated. To facilitate the evaluation, we used a modelling framework that combines different individual plant models with a reasonably uniform interface and source code, i.e. APSIM (Holzworth et al., 2014) for easy comparison of CO₂ responses among models. Still, there is substantial heterogeneity among the APSIM plant models, which differ in modelling approach and complexity. We see many parallels between individual APSIM models and the broader community of crop models. Thus we posit, and support this argument by a comparison of CO₂ responses among a broader range of models, that APSIM is a good case study for the potential diversity in crop models more generally.

Results and Discussion

The study highlights two important facts. Firstly, there is no consensus about assumed crop responses to [CO₂] to warrant universal inclusion and proper parameterization in crop models. The situation within a single modelling framework like APSIM mirrors that across many other models. It is not clear to which degree the response variation reflects true uncertainty in our understanding of the response of crops to elevated [CO₂], compared to arbitrary choices made by model developers. Secondly, the study reveals the limited degree of model validation against field data. Nevertheless, crop models are widely applied in climate change impact studies.

Modelled crop responses could be classified in four categories, responses of (i) photosynthesis and production, (ii) stomata and transpiration, (iii) nitrogen (N) dynamics,

and (iv) secondary processes. (i) Supported by bio-physiological evidence, photosynthesis and production responses for C3 crops are generally captured in crop models, but response magnitudes differ among models. For C4 crops, there is less consensus although observed C4 responses are probably an indirect effect of water savings (Leakey et al., 2009) and should be modeled alike. (ii) Stomatal and (up-scaled) transpiration responses are present in most but not all models, notwithstanding the experimental evidence for it. (iii) N dynamics responses (which result from improved photosynthetic N use efficiency and are related to increased photosynthetic efficiency and an observed decline in photosynthetic enzymes (e.g. Rubisco; Leakey et al., 2009)), are not widely simulated. In a few APSIM models, N responses are mimicked by reduced critical N concentration or plant N demand. In the DAISY model, the minimum, maximum and critical N concentration of plant parts are reduced with increasing [CO₂] (Olesen et al., 2004). Evidence from FACE and other experiments (e.g. Taub et al., 2008) on decreased tissue N concentration may be ignored in simulation models due to their relatively small magnitude or to the existing uncertainty about physiological mechanisms. Yet, consideration of N dynamic responses would enable to better simulate source-sink relationships, C-N dynamics and photosynthetic acclimation (i.e., a reduced response) to elevated [CO₂] (Boote et al., 2013), a phenomenon that is not well captured in most crop models (Yin, 2013). (iv) Secondary effects of elevated [CO₂], including shifts in root:shoot ratio, phenology or specific leaf area, are not universally captured in crop models, probably because experimental evidence is ambiguous.

Conclusions

This study revealed numerous differences in CO₂ responses among bio-physical crop models and a limited degree of validation against field data. Recommendations are made for proper documentation, harmonization and decent validation. Also incorporation of N dynamics responses to better represent source-sink relationships, C-N allocation, and photosynthetic acclimation, should be thoroughly evaluated.

Acknowledgements

EV receives post-doctoral research funding from the Research Foundation Flanders (FWO).

References

- Asseng, S., F. Ewert, C. Rosenzweig et al., (2013). *Nature Climate Change*, 3: 827–832.
 Bassu, S., N. Brisson, J.-L. Durand et al., (2014). *Global Change Biology*, 20: 2301–2320.
 Boote, K.J., J.W. Jones, J.W. White et al., (2013). *Plant, Cell & Environment*, 36: 1658–1672.
 Holzworth, D.P., N.I. Huth, P.G. deVoil et al., (2014). *Environmental Modelling & Software*, 62: 327–350.
 Leakey, A.D.B., E.A. Ainsworth, C.J. Bernacchi et al., (2009). *Journal of Experimental Botany*, 60: 2859–2876.
 Li, T., T. Hasegawa, X. Yin et al., (2015). *Global Change Biology*, 21: 1328–1341.
 Olesen, J.E., G.H. Rubæk, T. Heidmann et al., (2004). *Nutrient Cycling in Agroecosystems*, 70: 147–160.
 Rötter, R.P., T.R. Carter, J.E. Olesen et al., (2011). *Nature Climate Change*, 1: 175–177.
 Taub, D.R., B. Miller, and H. Allen. (2008). *Global Change Biology*, 14: 565–575.
 White, J.W., G. Hoogenboom, B.A. Kimball et al., (2011). *Field Crops Research*, 124: 357–368.
 Yin, X. (2013). *Annals of Botany*, 112: 465–475.

Assessing agroecosystems' Vulnerability and risk regarding extreme weather events

*F. M. Vanwindekens*¹ – *A. Gobin*² – *V. Planchon*¹

¹ Agriculture and natural environment Department, Walloon agricultural Research Centre (CRA-W), 9 Rue de Liroux B-5030 Gembloux, Belgium, f.vanwindekens@cra.wallonie.be, v. planchon@cra.wallonie.be

² Agri-environment & Climate change, Vlaamse Instelling voor Technologisch Onderzoek (VITO), 2400 Mol, Belgium

Introduction

Meteorological factors have a major influence on practices in agro-ecosystems. It has now been shown that human activities themselves (industrial, commercial and domestic) have an influence on the climate and extreme weather events (heavy rainfall, storms, hail, etc.) (IPCC, 2012). In order to support goods and services provided by agroecosystems, stakeholders are interested in decreasing their vulnerability to these events. Highly dependent on various factors, vulnerability is hardly assessed (Preston et al., 2011). The vulnerability of a system is the propensity or predisposition to be adversely affected by a hazard (IPCC, 2012).

We present an original method to assess the vulnerability of agro-ecosystems to extreme weather events at territorial scale. We present results from an early application of our method to the case of erosion in row crops.

Materials and Methods

Our method is divided in five steps. The first step is the identification of susceptible farming systems and extreme weather events in the study area. The second step consists of (i) reviewing major factors influencing vulnerability; (ii) formulating rules based on experts' knowledge to qualify these influences and (iii) evaluating the vulnerability using a Fuzzy Inference Systems (Meyer and Hornik, 2009). This second step is repeated for each aspect of vulnerability: economic, social and ecologic. The third step is the aggregation of the three aspects of vulnerability in a global vulnerability index. The fourth step is the evaluation of the risk based on the vulnerability of the farming systems and the probability of occurrence of the extreme weather event. Steps two to four are repeated for each of the susceptible farming systems and extreme weather events identified in step 1. The fifth step consists of evaluating a global indicator of risk at the territorial level.

Our method has been applied to the study of the ecological vulnerability of row crops (potatoes, maize, sugar beets) in Belgian agroecosystems to erosion due to heavy rain. Two factors have been selected: soil erodibility (Panagos et al., 2014) and percentage of row crops in the Utilised Agricultural Area (UAA) based on federal agricultural statistics. The ecological vulnerability of such agroecosystems was evaluated using a first basic set of rules (table 1) and 5-classes cones memberships functions ($r=0.2$, universe = from 0 to 1 by 0.01).

Table 1. Fuzzy rules used for evaluating the ecological vulnerability of row crops to heavy rain.
 UAA = Utilized Agricultural Area (municipalities)

	K-Factor	OPERATOR	Row crops in UAA	Ecological vulnerability
Rule 1	Very high	OR	Very high	Very high
Rule 2	High	AND	High	Very high
Rule 3	High	OR	High	High
Rule 4	Moderate	OR	Moderate	Moderate
Rule 5	Low	OR	Low	Low
Rule 6	Very low	OR	Very low	Very Low

Results and Discussion

The ecological vulnerability assessed by our method is shown at Figure 1. The highest vulnerability indices occur in the western part of the country and, to a lesser extent, in the centre and the north. Lowest vulnerability indices to soil losses occur in the southern part of the country. These early results are confirmed by mud flood data obtained from the Ministry of Environment. This first application is promising for analysing the various aspects of vulnerability by combining various kinds of information. Further development will include an extension of factors taken into account and the assessment of other aspects of vulnerability (economic, social) in various agricultural contexts (grassland, orchards).

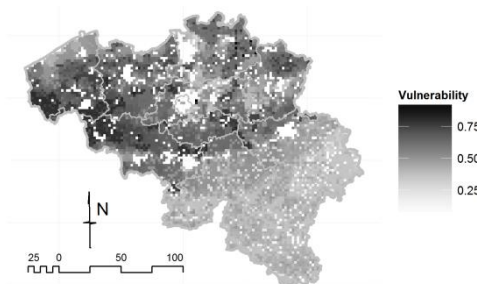

Figure 1. Ecological vulnerability of row crops to heavy rain in Belgium

Conclusions

A fuzzy rule based approach is relevant for assessing the multi-factorial and multi-aspects concept of vulnerability in agroecosystems. The approach will be further developed for obtaining a global assessment of agroecosystems vulnerability to extreme weather events.

References

IPCC (2012). Cambridge University Press, Cambridge, 594 pp.
 Meyer, D. and K. Hornik (2009). Journal of Statistical Software 31(2): 1–27.
 Panagos, P., K. Meusburger, C. Ballabio et al., (2014). Science of Total Environment, 479-480: 189–200.
 Preston, B. L., E. J. Yuen and R. M. Westaway (2011). Sustainability Science, 6(2): 177–202.

Model-based functional uncertainty analyses to inform required accuracy of PAWC estimation methods.

*K. Verburg*¹ – *H. Horan*² – *J. Hunt*³ – *N. Dalgliesh*⁴ – *B. Cocks*⁴ – *T. Swan*³ – *S. Henry*⁵ – *M. Glover*⁶

¹ CSIRO Agriculture, GPO Box 1666, Canberra ACT 2601, kirsten.verburg@csiro.au

² CSIRO Agriculture, Brisbane Qld 4001

³ CSIRO Agriculture, Canberra ACT 2601

⁴ CSIRO Agriculture, Toowoomba Qld 4350

⁵ CSIRO Health and Biosecurity, Canberra ACT 2601

⁶ CSIRO Land and Water, Canberra ACT 2601

Introduction

In dryland agriculture knowledge of the plant available water capacity (PAWC) and the amount of water stored (PAW) at sowing are important inputs for yield forecasting and informing management decisions. In Australia a simple, yet time-consuming field based methodology (Burk and Dalgliesh, 2013) has been used to characterize more than 1000 soils for their PAWC. The data is geo-referenced and freely available to farmers and advisors (<https://www.apsim.info/Products/APSsoil.aspx>) and in a format that can be used directly by the APSIM model (Holzworth et al., 2014) and its yield forecasting tool Yield Prophet® (<http://www.yieldprophet.com.au>).

Extrapolating from the point-based dataset to predict PAWC at other locations of interest or even choosing a suitable soil from the database is, however, often a challenge, especially in highly variable landscapes. The use of soil-landscape associations and pedotransfer functions (separately or combined) are methods under investigation to assist with this process.

Developing methods to predict or estimate PAWC prompts the question ‘How accurate does the PAWC estimate need to be?’ This paper explores different approaches that may be applied to shed a light on this question and provide farmers and advisors with some guidance. A variety of model based functional uncertainty analyses are used to explore the issue of uncertainty in PAWC estimates and its impact.

Materials and Methods

A number of different approaches were trialed to consider uncertainty contained in PAWC measurements or estimates, spatial variability in PAWC and PAW and to what extent these uncertainties may affect yield forecasts and management decisions in particular. Most of the methods were opportunistic, linked to availability of a dataset or discussions with groups of farmers and advisors that prompted us to set-up modelling scenarios to answer their questions.

All modelling analyses were performed with the APSIM model (Holzworth et al., 2014) configured with a tipping bucket soil water module (SoilWat) and wheat as a model crop. Historical climate data were obtained from the SILO database (Jeffrey et al., 2001; <https://www.longpaddock.qld.gov.au/silo/>).

Results and Discussion

1. Three soil characterisations in a single field trial in southern NSW, Australia resulted in PAWC ranging from 196 to 224 mm. The range in PAW calculated for 42-48 individual soil cores taken from the same area for gravimetric, pre-sowing soil water (2 seasons) and using these three PAWC profiles varied widely in both years (10 tou > 100 mm). The effects of variability in PAWC and PAW were both considered in an APSIM modelling analysis mimicking a farmer choosing a soil characterisation, 'bulking' six random soil cores for PAW calculation, and using the information to forecast yield with Yield Prophet® and consider the yield benefit of topdressing with nitrogen. Running this scenario 100 times for each PAWC characterisation and each season demonstrated that the range in calculated PAW was considerably reduced through 'bulking' 6 cores and that in one of the seasons the decision to top-dress or not was hardly affected.
2. The ranges of PAWC values measured on soils in the Central Darling Downs in Queensland, Australia compared well and fell within the 50-mm interval estimates contained in a land resource assessment of the area. As in the previous analysis, considering the impact of uncertainty in PAWC on management decisions rather than yield alone provides a better link to the reality for farmers and advisors.
3. A hill transect of PAWC profiles in southern NSW, Australia, highlighted the need to develop methods for extrapolation of both PAWC and accompanying fertility data.
4. Simulations across the Australian wheat belt mimicking the measurement of crop lower limit (CLL) in the field drew attention to possible year-to-year variability in measured CLL values that may not be captured if the PAWC is only measured once. Seasonal variability was site (climate x soil) specific.

Conclusions

Through a series of loosely linked analyses, this paper suggests that uncertainty needs to be considered for both measured and estimated PAWC values. Assessment of acceptable uncertainty needs to be determined through functional analysis mimicking the intended use of the data. Results need to be compared with the impact of other uncertainties, like PAW which may vary considerably and have similar or greater effect.

Acknowledgements

Funding from Grains Research and Development Corporation is acknowledged as well as the efforts of many CSIRO staff and collaborators characterizing soils for PAWC and helpful discussions with Harm van Rees.

References

- Burk L, Dalgliesh N (2013) Estimating plant available water capacity. GRDC Kingston ACT. <http://www.grdc.com.au/GRDC-Booklet-PlantAvailableWater>.
- Harris, P.S., Biggs, A.J.W. and Stone, B.J. (eds). (1999). Central Darling Downs Land Management Manual. Department of Natural Resources, Queensland. DNRQ990102
- Holzworth, D.P., N.I. Huth, P.G. deVoil, et al., (2014). APSIM—evolution towards a new generation of agricultural systems simulation. *Environmental Modelling & Software*, 62, 327-350.
- Jeffrey, S.J., Carter, J.O., Moodie, K.B et al., (2001). Using spatial interpolation to construct a comprehensive archive of Australian climate data External link icon, *Environmental Modelling & Software*, 16: 309-330.

A promising tool to model heterogeneity in crop systems: functional-structural plant modelling

J. de Vries^{1,2} – *J. B. Evers*²

¹ Laboratory of Entomology, Wageningen University, Droevendaalsesteeg 1, Wageningen, the Netherlands
jorad.devries@wur.nl

² Centre for Crop Systems Analysis, Wageningen University, Droevendaalsesteeg 1, Wageningen, the Netherlands

Introduction

Ecophysiological processes related to the interaction between neighboring plants and micro-environmental factors drive plant growth and functioning in response to local conditions. They act on a scale that is often small and complex but can have a significant impact on crop performance. Processes such as phenotypic plasticity, compensatory growth due to herbivory, and root-soil interactions play a key role in understanding and predicting crop performance, yet they are underrepresented or overly simplified in conventional crop models. Here lies a challenge that can be met by a class of plant models termed functional structural plant (FSP) models (Vos et al., 2010). These models simulate plant form and function in three dimensions over time and provide the opportunity to simulate the interaction between plants and the heterogeneity in their environment. In FSP models, simulation of the feedback between the local environment and plant growth and development allows us to simulate plant architecture as it changes over time. This introduces heterogeneity in light climate that determines leaf-level photosynthesis rate (e.g. Sarlikioti et al., 2011) as well as shade avoidance growth (Bongers et al., 2014), both key determinants of crop performance. Here, we outline some of the recent advances in crop science using FSP models and we propose their use to improve conventional crop models.

FSP model applications

Intercropping, the practice of growing more than one crop species simultaneously on the same field, is a crop system in which heterogeneity in the light environment caused by the planting pattern, differences in plant architecture and in sowing time of the intercropped species can lead to significant increases in crop production and disease suppression (Brooker et al., 2015). In Zhu et al., (2015) FSP models have been used to demonstrate that much of the yield increase of an intercrop compared to the monocrop could be attributed to the plastic responses of the plants to the heterogeneity in light environment caused by the intercrop field design. To this end, FSPM was used to selectively switch on and off particular plastic traits of the component species in the intercrop setting, something which is impossible to do experimentally. The heterogeneity in aboveground conditions caused by intercropping is also introduced belowground: in a mixed species design, the root systems of the component species interact and compete for resources. Interaction between root architecture and soil heteroge-

neity is a field that is notoriously hard to study and that has been a focus of FSP models for decades (Dunbabin et al., 2013). Here too FSP models provide a valuable tool to simulate the effects of heterogeneity caused by clustering different root architectures in an mixed crop on plant performance (e.g. Postma and Lynch, 2012). Finally, we propose that FSP models can be applied in the field of plant-insect interactions: insect herbivory inherently introduces heterogeneity in the canopy by removing leaf area, thereby not only hampering their host but benefitting its neighbors who will experience higher light capture. This potentially has significant effects on crop productivity depending on the timing and the intensity of the herbivory, as well as the response of the plants.

Outlook

FSP models fill an interesting niche in the world plant-plant and plant-environment interactions and we see its role as being complementary to conventional crop models. For example, interactions between plant growth and insect herbivory or planting pattern can be quantified using FSP models, and subsequently incorporated in crop models as descriptive relationships, thereby potentially improving crop model predictions. The high spatial detail of FSP models is invaluable to test assumptions and generate hypothesis that could help to improve conventional crop models. FSP models can also play an important role in developing management strategies (e.g. optimization of cotton management, Gu et al., 2014) and help plant breeding by ideotyping plant architectural as well as physiological traits (Lynch, 2013).

References

- Bongers, F.J., J.B. Evers, N.P.R. Anten, R. Pierik (2014). From shade avoidance responses to plant performance at vegetation level: using virtual plant modelling as a tool. *New Phytologist* 204: 268-272.
- Brooker, R.W., A.E. Bennett, W.F. Cong et al., (2015). Improving intercropping: a synthesis of research in agronomy, plant physiology and ecology. *New Phytologist* 206: 107-117.
- Dunbabin, V.M., J.A. Postma, A. Schnepf et al., (2013). Modelling root-soil interactions using three-dimensional models of root growth, architecture and function. *Plant and Soil* 372: 93-124.
- Gu S, J.B. Evers, L. Zhang et al., (2014). Modelling the structural response of cotton plants to mepiquat chloride and population density. *Annals of Botany* 114: 877-887.
- Lynch, J.P.. 2013. Steep, cheap and deep: an ideotype to optimize water and N acquisition by maize root systems. *Annals of Botany* 112: 347-357.
- Postma, J.A., J.P. Lynch (2012). Complementarity in root architecture for nutrient uptake in ancient maize/bean and maize/bean/squash polycultures. *Annals of Botany* 110: 521-534.
- Sarikioti V, P.H.B. de Visser, L.F.M. Marcelis LFM (2011) Exploring the spatial distribution of light interception and photosynthesis of canopies by means of a functional-structural plant model. *Annals of Botany* 107: 875-883.
- Vos J, J.B. Evers, G. Buck-Sorlin et al., (2010). Functional-structural plant modelling: a new versatile tool in crop science. *Journal of Experimental Botany* 61: 2102-2115.
- Zhu J, W. van der Werf, N.P.R. Anten et al., 2015. The contribution of phenotypic plasticity to complementary light capture in plant mixtures. *New Phytologist* 207: 1213-1222.

A framework for evaluating uncertainty in crop model predictions

*D. Wallach*¹–*P. Thorburn*²–*S. Asseng*³–*A. J. Challinor*^{4,5}–*F. Ewert*⁶–*J. W. Jones*³–*R. P. Rötter*⁷–*A. Ruane*⁸

¹ UMR 1248 Agrosystèmes et développement territorial (AGIR), INRA, 31326 Castanet-Tolosan Cedex, France, email: daniel.wallach@toulouse.inra.fr.

² CSIRO Agriculture

³ Agricultural & Biological Engineering Department, University of Florida

⁴ Institute for Climate and Atmospheric Science, School of Earth and Environment, University of Leeds

⁵ CGIAR-ESSP Program on Climate Change, Agriculture and Food Security, International Centre for Tropical Agriculture (CIAT)

⁶ Institute of Crop Science and Resource Conservation INRES, University of Bonn

⁷ Environmental Impacts Group, Natural Resources Institute Finland (Luke)

⁸ NASA Goddard Institute for Space Studies

Introduction

It is essential to associate uncertainty estimates with process-based crop simulation model results, in order to know how much confidence to place in those model results. The most common approach has been to base uncertainty on comparisons of simulated values with observations, and to summarize the results as a mean squared error or similar distance measure (Basso et al., 2016). The implicit assumption is that application of models to new situations will use exactly the same model as used for hindcasts and that predictions will have errors similar to those of the past. However, there have also been alternative approaches to uncertainty. One type of study evaluates the uncertainty in predictions engendered by uncertainty in model inputs and/or parameters (Wallach et al., 2014). Another, more recent type of study involves ensembles of crop models and uses the variability among models as an indication of uncertainty (Asseng et al., 2013). It seems important then to develop an overall framework for considering uncertainty, which can help clarify the relationships between these approaches and which can help orient future estimations of uncertainty.

Materials and Methods

Model uncertainty measures the distribution of $Y-f(X;\Theta)$, where Y is the true value of the predicted quantity and $f(X;\Theta)$ is the corresponding simulated value, with f being the model structure, X the model inputs and Θ the model parameters. To summarize this distribution, we can use mean squared error of prediction (MSEP), defined as $MSEP=E\{[Y-f(X;\Theta)]^2\}$. If the model is considered as fixed, then the expectation is only over Y and X . This can be estimated as the mean of hindcast squared errors. This has been the common approach in the past. The alternative is to treat the predictor as a random variable, as a result of treating one or more of model structure, model inputs and model parameters as random variables. This is in line with the standard approach in statistics, where the estimator of model parameters is treated as a random variable. The main advantage of this approach is that one can estimate $MSEP(X)$, which is mean squared error of prediction for a specific set of inputs, i.e. for a specific prediction

situation. For example, the random approach can be used to explore specifically how model structure uncertainty or parameter uncertainty will affect prediction uncertainty under climate change. We show that $MSEP(X)$ is the sum of two terms; a variance term, which can be estimated based on a simulation experiment, and a squared bias term, which must be estimated using hindcasts. We also show how the separate contributions to the variance term, due to uncertainty in structure, inputs and parameters, can be estimated.

Results and Discussion

$MSEP(X)$, treating the predictor as a random variable, was calculated based on results from a wheat model ensemble study (Asseng et al., 2013) using 27 models applied at four locations. The uncertainty picture based on $MSEP(X)$ is quite different than that based on MSEP. Most flagrantly, MSEP is the same for all prediction situations, whereas $MSEP(X)$ varies depending on the quantity being predicted. Importantly, it was found that the squared bias contribution to $MSEP(X)$ is small compared to the model variance term.

Conclusions

The different approaches to crop model uncertainty, namely using hindcasts, based on uncertainty in parameters and/or inputs and based on model ensembles, can all be related to MSEP. The first refers to a fixed model, and can only be estimated on the average over prediction situations. The other approach is to treat model structure, parameters and estimated inputs as random variables, and to take expectations over their distributions. In this case MSEP can be evaluated for each prediction situation, giving $MSEP(X)$. This is a major advantage, since it allows us to judge in each case whether crop models are fit-for-purpose (for example, for predicting the effect of climate change). We suggest therefore that this should be a major approach in the evaluation toolkit for crop models. However, the advantage of $MSEP(X)$ depends on the fact that the squared bias term is small, since that term is estimated on average over predictions. This should be tested more thoroughly.

Acknowledgements

The role of AgMIP in making possible the collaboration underlying this study is gratefully acknowledged.

References

- Asseng S, Ewert F, Rosenzweig C et al., (2013) Uncertainty in simulating wheat yields under climate change. *Nature Climate Change*, 3, 827–832.
- Basso B, Liu L, Ritchie JR (2016) A comprehensive review of the CERES-Wheat, -Maize and -Rice models' performances. *Advances in Agronomy*, 136.
- Wallach D, Makowski D, Jones JW, Brun F (2014) *Working with Dynamic Crop Models*, 2nd Edition. Academic Press, London.

**Inter-comparison of wheat models to identify knowledge gaps
and improve process modeling**

*E. Wang*¹ – *P. Martre*² – *S. Asseng*³ – *F. Ewert*⁴ – *Z. Zhao*¹ – *A. Maiorano*² –
*R. P. Rötter*⁵ – *B. A. Kimball*⁶ – *M. J. Ottman*⁷ – *G. W. Wall*⁶ – *J. W. White*⁶ –
*P. K. Aggarwal*⁸ – *P. D. Alderman*⁹ – *J. Anothai*¹⁰ – *B. Basso*¹¹ – *C. Biernath*¹² –
*D. Cammarano*³ – *A. J. Challinor*^{13,14} – *G. De Sanctis*¹⁵ – *J. Doltra*¹⁶ – *E. Fereres*^{17,18} –
M. Garcia-Vila^{17,18} – *S. Gayler*¹⁹ – *G. Hoogenboom*¹⁰ – *L. A. Hunt*²⁰ –
R. C. Izaurralde^{21,22} – *M. Jabloun*²³ – *C. D. Jones*²¹ – *K. C. Kersebaum*²⁴ – *A.-K. Koehler*¹³
– *C. Müller*²⁵ – *L. Liu*²⁶ – *S. Naresh Kumar*²⁷ – *C. Nendel*²⁴ – *G. O’Leary*²⁸ – *J.E. Olesen*²³
– *T. Palosuo*⁵ – *E. Priesack*¹² – *M. P. Reynolds*⁹ – *E. Eyshi Rezaei*⁴ – *D. Ripoche*¹⁵ –
*A. C. Ruane*²⁹ – *M. A. Semenov*³⁰ – *I. Shcherbak*¹¹ – *C. Stöckle*³¹ – *P. Stratonovitch*³⁰ –
*T. Streck*³² – *I. Supit*³³ – *F. Tao*^{5,34} – *P. Thorburn*³⁵ – *K. Waha*²⁵ – *D. Wallach*^{35,36} –
*J. Wolf*³³ – *Y. Zhu*²⁶

¹ CSIRO Agriculture, Black Mountain ACT 2601, Australia, e-mail: enli.wang@csiro.au

² INRA, UMR0759 LEPSE, F-34 060 Montpellier, France, e-mail: pierre.martre@supagro.inra.fr

³ ABE Department, University of Florida, Gainesville, FL 32611, USA.

⁴ INRES, University of Bonn, D-53115, Germany.

⁵ Luke, FI-00790 Helsinki, Finland ⁶ ARS-USDA, ALARC, Maricopa, AZ 85138, USA.

⁷ The School of Plant Sciences, University of Arizona, Tucson, AZ 85721, USA

⁸ CGIAR Research Program on Climate Change, Agriculture and Food Security, IWMI, New Delhi 110012, India

⁹ CIMMYT, 06600 Mexico, D.F., Mexico

¹⁰ AgWeatherNet Program, Washington State University, Prosser, Washington 99350, USA

¹¹ GS and W.K. Kellogg Biological Station, Michigan State University East Lansing, MI 48823, USA

¹² ISE, Helmholtz Zentrum München, Neuherberg, D-85764, Germany

¹³ ICAS, School of Earth and Environment, University of Leeds, Leeds LS29JT, UK

¹⁴ CGIAR-ESSP Program on Climate Change, Agriculture and Food Security, CIAT, A.A. 6713, Cali, Colombia

¹⁵ INRA, US1116 AgroClim, F- 84 914 Avignon, France

¹⁶ CIFA, 39600 Muriedas, Spain

¹⁷ Departement of Agronomia, University of Cordoba, Apartado 3048, 14080 Cordoba, Spain

¹⁸ IAS CSIC, Cordoba 14080, Spain

¹⁹ WESS Competence Cluster, University of Tübingen, D-727074 Tübingen, Germany

²⁰ Department of Plant Agriculture, University of Guelph, Guelph, ON N1G 2W1, Canada

²¹ Department of Geographical Sciences, University of Maryland, College Park, MD 20742, USA

²² Texas A&M AgriLife Research and Extension Center, Texas A&M University, Temple, TX 76502, USA

²³ Department of Agroecology, Aarhus University, 8830 Tjele, Denmark

²⁴ Institute of Landscape Systems Analysis, ZALF, D-15374 Müncheberg, Germany

²⁵ Potsdam Institute for Climate Impact Research, D-14473 Potsdam, Germany

²⁶ College of Agriculture, Nanjing Agricultural University, Nanjing, Jiangsu, 210095, China

²⁷ Centre for Environment Science and Climate Resilient Agriculture, IARI PUSA, New Delhi 110 012, India

²⁸ Landscape & Water Sciences, Department of Environment and Primary Industries, Horsham 3400, Australia

²⁹ NASA Goddard Institute for Space Studies, New York, NY 10025, USA

³⁰ Computational and Systems Biology Department, Rothamsted Research, Harpenden, Herts, AL5 2JQ, UK

³¹ BSE Departement, Washington State University, Pullman, WA 99164-6120, USA

³² Institute of Soil Science and Land Evaluation, University of Hohenheim, D-70599 Stuttgart

³³ PPS and ESS, Wageningen University, 6700AA Wageningen, The Netherlands

³⁴ Institute of Geographical Sciences and Natural Resources Research, CAS, Beijing 100101, China

³⁵ CSIRO Agriculture, Brisbane, Queensland 4102, Australia

³⁶ INRA, UMR 1248 AGIR, F-31 326 Castanet-Tolosan, France

Introduction

An intercomparison of wheat models revealed that the uncertainty in simulated yield increases with rising temperature (Asseng et al., 2013) and the mean of the multi-model ensemble (MME) simulations best matched the observations (Martre et al., 2015). These findings highlight the need for MME approach to better address yield projection uncertainty. However, the MME approach itself does not lead to improvement in process understanding. Here we extend the model intercomparison to investigate how the uncertainties in simulation results arise from process-level algorithms and parameterization in the models and to identify knowledge gaps.

Materials and Methods

We systematically compared 29 wheat models (Asseng et al., 2015) in terms of how key temperature-responsive physiological processes are simulated. We extracted the algorithms used in these models and categorized the temperature response equations into four types based on how the cardinal temperatures are defined. To demonstrate the impact of the different temperature equations on simulated phenology, total above ground biomass and grain yield, we implemented the four types of temperature responses in the APSIM and *SiriusQuality* models and tested the modified models against the Hot Serial Cereal field experiment (Wall et al., 2011).

Results and Discussion

Our analysis revealed contrasting temperature response functions used for the same physiological process among different models. These differences impacted directly on the sensitivity of simulated yield to temperature changes, particularly at high temperature range. The range of simulated yield caused by variations of temperature response functions in APSIM and *SiriusQuality* was on average 52 % and 64 % of the uncertainty of the MME, respectively. These results demonstrate that the contrasting temperature response functions implemented in the models is a major cause of the uncertainty in the simulated yield. Finally, we developed improved temperature response functions for key processes. Their implementation into APSIM and *SiriusQuality* led to improved yield simulations.

Conclusions

The contrasting temperature response functions for simulating key physiological processes in current wheat models are a major cause of the uncertainty in simulated yield. Inter-comparison of modeling approaches enabled to identify knowledge gaps and improvement in process modeling.

References

- Asseng, S., Ewert, F., Martre, P. et al., (2015) *Nature Climate Change*, 5: 143-147
Asseng, S., Ewert, F., Rosenzweig, C. et al., (2013) *Nature Climate Change* 3: 827-832.
Martre, P., Wallach, D., Asseng, S. et al (2015) *Global Change Biology* 21: 911-925.
Wall, G.W., Kimball, B.A., White, J.W., Ottman, M.J. (2011) *Global Change Biology* 17: 2113-2133.

Canopy temperature for simulation of heat stress in irrigated wheat in a semi-arid environment: a multi-model comparison

*H. Webber*¹ – *P. Martre*² – *S. Asseng*³ – *B. Kimball*⁴ – *J. White*⁴ – *M. Ottman*⁵ – *G.W. Wall*⁴ – *G. de Sanctis*⁶ – *J. Doltra*⁷ – *R. Grant*⁸ – *B. Kassie*³ – *A. Maiorano*² – *J. E. Olesen*⁹ – *D. Ripoche*¹⁰ – *E. E. Rezaei*¹ – *M. A. Semenov*¹¹ – *P. Stratonovitch*¹¹ – *F. Ewert*¹

¹ Crop Science, INRES, University of Bonn, Katzenburgweg 5, Bonn, D-53115, hwebber@uni-bonn.de

² UMR759 LEPSE, INRA

³ Agricultural & Biological Engineering Department, University of Florida

⁴ U.S. Arid-Land Agricultural Research Center, Agricultural Research Service, USDA

⁵ School of Plant Sciences, University of Arizona

⁶ Joint Research Centre, European Commission

⁷ Cantabrian Agricultural Research and Training Centre, CIFA

⁸ Renewable Resources, Faculty of Agriculture, University of Alberta

⁹ Department of Agroecology, Aarhus University

¹⁰ AgroClim, INRA

¹¹ Computational and Systems Biology Department, Rothamsted Research

Introduction

Evidence suggests that brief periods of high temperatures are already causing large reductions in cereal yield (Schlenker and Roberts, 2009). While most crop models account for temperature effects on growth and development rates, it is only recently that crop modellers have attempted to explicitly simulate heat stress effects such as accelerated senescence or the failure of reproductive processes. Most attempts to model heat stress have used air temperature (T_{air}), rather than crop canopy temperature (T_c) which has been shown to be a better predictor of stress thermal time than T_{air} (Siebert et al., 2014). Models of canopy temperature also differ ranging from empirical (EMP) to complex iterative models that solve an energy balance at the crop canopy surface correcting for atmospheric stability conditions (EBSC). A greatly simplified variation of the energy balance models assumes neutral stability conditions (EBN), avoiding iteration. The objectives of this study are: (1) to compare EMP, EBN, and EBSC approaches to simulate T_c and grain yield, and (2) to assess if simulation of T_c improves the ability of crop models to capture heat stress impacts on wheat under irrigated conditions as compared to using T_{air} only.

Materials and Methods

Nine crop models simulated crop growth and development for irrigated spring wheat in Arizona for a series of planting dates. The range of planting dates resulted in different temperature regimes during crop development. The simulations were conducted twice: (1) using T_c on processes sensitive to heat stress and (2) using T_{air} on processes sensitive to heat stress. Three models could not complete step (2): two for technical and one for conceptual reasons. The processes sensitive to heat stress (i.e. grain number, harvest index, final grain yield and/or leaf senescence) differed between

models. Models normally using T_c for simulation of growth or development continued to use T_c on these processes in both simulation steps. Modellers were asked to set anthesis and maturity dates to within ± 1 day of observations. Observed crop growth and T_c data from all sowing dates were available for calibration as modellers has used the data in a previous modelling exercise (Asseng et al., 2015).

Results and Discussion

The ability of the models to reproduce the observed difference between daily maximum values of T_c and T_{air} ($\Delta T = T_c - T_{air}$) differed between the approaches considered. The three EBSC models had the lowest root mean square error, (RMSE; 2.9°C) while the three EBN exhibited the highest RMSE (6.7°C). The correlations with observations were similar for the three EMP models and the three EBN models, with R^2 values of 0.10 and 0.02 respectively. The RMSE of the EMP models (3.9°C) was close to that of the EBSC models, in both cases better than the EBN models. All three groups exhibited bias towards over-estimation of T_c , the bias of the EBN models was greatest. Surprisingly, the EMP models performed much better than the EBN models. However, the EMP approaches may not be appropriate in other environments or climates as they largely rely on empirical relationships. The poor performance of the EBN methods is expected, given that the assumption of neutral stability implies that ΔT should be close to 0. Despite their relatively poor simulation of T_c , the models which used EBN simulated grain yields with a RMSE value of 1.7 t ha⁻¹, slightly better than EMP or EBSC models, which had RMSE values of 1.8 and 2.3 t ha⁻¹, respectively. For the six models that were used with both T_c and T_{air} on processes driving heat stress responses, the use of T_c lead to lower values of RMSE for grain yield for five of the models, though the improvements were very small for two models despite the large values of observed ΔT . This result suggests that approaches, and respective parameterizations, to simulate heat stress should be more thoroughly evaluated. Most models used in this study report using high temperature thresholds for their various heat stress responses considerably higher than values reported in the literature (Porter and Gawith, 1999).

Conclusions

The approaches to simulate T_c varied widely in their ability to reproduce the observed T_c with the commonly used EBN approaches performing much worse than either EMP or EBSC. The improvement in grain yield simulation with T_c compared to T_{air} was substantial for two models, and limited for the others. Poor performance in simulating T_c did not result in poor simulation of grain yield, highlighting that more systematic evaluation of approaches to model heat stress in wheat is needed.

References

- Asseng, S., Ewert, F., Martre, P., et al., (2015). *Nature Climate Change* 5 143–147.
 Porter, J., Gawith, M. (1999). *European Journal of Agronomy*, 10: 23-36.
 Schlenker, W., Roberts, M.J. (2009). *Proceedings of the National Academy of Sciences*, 106: 15594-15598.
 Siebert, S., Ewert, F., Rezaei, E.E., Kage, H., Graß, R. (2014). *Environmental Research Letters*, 9: 044012.

Uncertainty in future European irrigation water demand

*H. Webber*¹ – *R. Oomen*¹ – *T. Gaiser*¹ – *E. Teixeira*² – *G. Zhao*¹ – *A. Srivastava*¹ –
*A. Zimmermann*³ – *D. Wallach*⁴ – *F. Ewert*¹

¹ Crop Science, Institute of Crop Science and Resource Conservation, University of Bonn, Katzenburgweg 5, D-53115 Bonn, tgaiser@uni-bonn.de

² The New Zealand Institute for Plant & Food Research Limited

³ Economic and Agricultural Policy, Institute for Food and Resource Economics, University of Bonn

⁴ Agrosystemes et developpement territorial, INRA

Introduction

While crop models are widely used to assess the change in crop productivity with climate change, their skill in assessing future irrigation water demand in large area impact assessments is relatively unknown. Elliott et al., (2014) found that the relative change in global potential irrigation demand to 2050 differed from median values by -5 to +15 % for global hydrology and gridded crop models, each using different approaches for various aspects of crop water use. The objectives of this study are to: (1) determine which aspects of the models contribute most to the variability in estimations of crop water use; and (2) assess the uncertainty in future European irrigation water demand arising from choice of ET₀ method.

Materials and Methods

To address the first objective, the SIMPLACE crop modelling framework is used, combining the LINTUL5 crop model with different approaches for simulating 5 aspects of crop water use (water balance, ET₀ method, crop soil water extraction method, soil evaporation estimate and root growth) resulting in 51 modelling approaches. The modelling approaches for simulating maize growth and water use are calibrated and evaluated with datasets of different irrigation experiments in France and New Zealand. The contribution of each component to the total variability in crop water use are quantified using total sensitivity indices (TS) for 5 levels of water availability (from full irrigation to completely rainfed). For the second objective, maize growth and water use are simulated across the EU27 at a spatial resolution of 25 km² using SIMPLACE with four of the modeling solutions. The solutions each use LINTUL5, but differ in their ET₀ method: Hargreaves, Penman, FAO-Penman Monteith and Priestley-Taylor. Simulations are conducted with full irrigation all soils currently used for agriculture. Periods considered are a historical baseline and two scenarios (2050 and 2080) using three global circulation models (GCMs) and representative concentration pathways (RCPs). Calibration in each simulation unit ensures anthesis and maturity dates correspond to observations.

Results and Discussion

Under high levels of irrigation, the ET₀ method explains more variability in seasonal crop water use than any other factor for both the New Zealand and French

experiments. When soil water is limited, other factors explain crop water use, though most variability in grain yield under drought is explained by ET_0 method (results not shown). Results for the European assessment of crop water demand under irrigation indicate that averaged across Europe, the Hargreaves, FAO Penman-Monteith and Priestley-Taylor methods estimate similar values, while the Penman estimate is more than 15 % lower (Fig. 1). This difference is largely similar in the historical and scenario periods. However the average values hide spatial variability. The Penman ET_0 estimate is as much as 50 % lower than the Penman-Monteith estimate in Southern Europe. Priestley-Taylor tends to underestimate ET_0 compared to Penman-Monteith in large parts of central and southern Europe, with higher estimates in coastal regions. Hargreaves was more variable across Europe. The degree of uncertainty in the results highlights the need for improving and more intensive, multi-site testing of the crop water use modelling approaches from crop models under different irrigation levels.

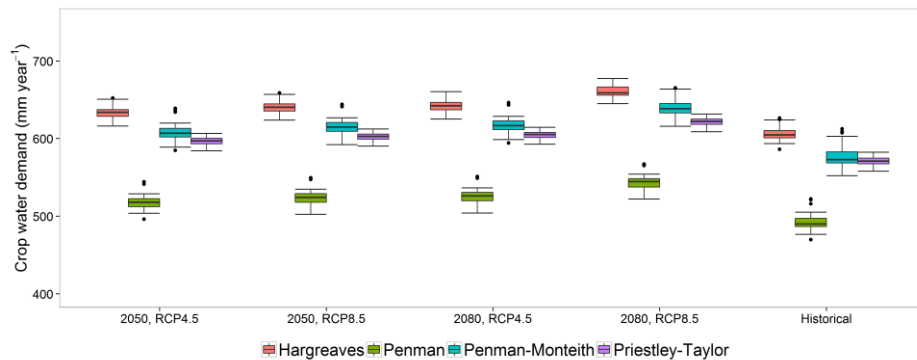

Figure 1. European crop water demand (mm year^{-1}) under full irrigation for four scenarios (2 RCPs and 2 periods) averaged over three climate models and the historical period. For each period, plots are shown for the Hargreaves, Penman, Penman-Monteith and Priestley-Taylor ET_0 methods.

Conclusions

This analysis indicates that if the ET_0 estimates in crop models can be improved, the uncertainty in irrigation water demand as well as in yield estimates under drought can be reduced. Improving modeling of the dynamics of crop water movement or root growth seems only critical when estimating crop water use under drought conditions. The uncertainty in absolute estimates of future crop water demand at a European scale serves as a barrier to using crop models as tools in guiding investments in irrigation under climate change.

References

Elliott, J., Deryng, D., Müller, C., Frieler, K., Konzmann, M., Gerten, D., Glotter, M., Flörke, M., Wada, Y., Best, N., 2014. Constraints and potentials of future irrigation water availability on agricultural production under climate change. *Proceedings of the National Academy of Sciences*, 111: 3239-3244.

Simulating the impact of winter conditions on the survival and yield potential of winter wheat

*A. de Witt*¹ – *R. P. Rötter*² – *T. Palosuo*² – *A. K. Bergjord*³ – *O. Virchenko*⁴ – *A. Kleshenko*⁴

¹ Alterra, Wageningen-UR, The Netherlands. (allard.dewit@wur.nl)

² Environmental Natural Resources Institute (Luke), 01301 Vantaa, Finland

³ Norwegian Institute for Agricultural and Environmental Research, Grassland and Landscape Division Kvithamar, N-7500, Stjørdal, Norway

⁴ State Enterprise National Scientific & Research Institute on Agricultural Meteorology, Russian Federation

Introduction

There are many important production regions for winter-crops that are characterized by harsh winter conditions such as Northern and Eastern Europe, the Russian Federation, North America, Central-Asia and China. In these regions the growth and yield potential of winter crops is affected by very low temperatures during winter influencing plant survival. However, frost and low temperature effects on crop survival and yield potential are relatively poorly understood. For that reason, most crop simulation models do not take the impact of winter damage during winter into account. Here we describe the setup, calibration and testing of an extended WOFOST crop model for estimating the impact of frost on crop survival and the impact on yield.

Materials and Methods

Experimental data for calibration and testing of the models were available on several levels. First of all, detailed trials from freezer experiments were available from Norway where plants were systematically exposed to temperatures ranging from -6 to -24 degrees Celsius. Second, long-term winter wheat variety trial data from Finland were available consisting of several sites including years with frost damage as a result of low temperatures and little snow cover. Finally, data from the Tula region in Russia were available providing 20 stations from the RosHydroMet network covering both synoptic weather and agrometeorological records including reports on field conditions and the source of crop damage occurring.

As a basis for simulating direct impact of low temperature on winter-wheat we applied the FROSTOL model (Bergjord et al., 2008). Frost tolerance in FROSTOL is described as the state variable LT50 [°C] which can be interpreted as the temperature at which 50 % of the plants die. FROSTOL was combined with the snow model to simulate the buildup of snow cover. Finally, FROSTOL was incorporated in WOFOST (Boogaard et al., 2014) for estimating the impact on wheat growth, biomass and yield.

Results and Discussion

The FROSTOL model describes the course of the LT50 during the growing season and was combined with a survival function that describes the percentage of plants being killed as a function of hardening state (LT50) and temperature. The survival function

was implemented as a logistic model (figure 1, $R^2=0.97$). For connecting FROSTOL to WOFOST we assume that the reduction in biomass equals the percentage of plants being killed.

For applying WOFOST/FROSTOL a cultivar-specific frost tolerance must be provided. Information on lethal low temperatures limits of wheat (Porter and Gawith, 1999) show a large variability between -2 and -24 degrees. More specific information for Russian cultivars shows a range between -15 and -25 degrees. Given that wheat cultivars are often adapted to the local climatic conditions, the critical lethal temperature must be selected carefully in order to be representative for the region being studied.

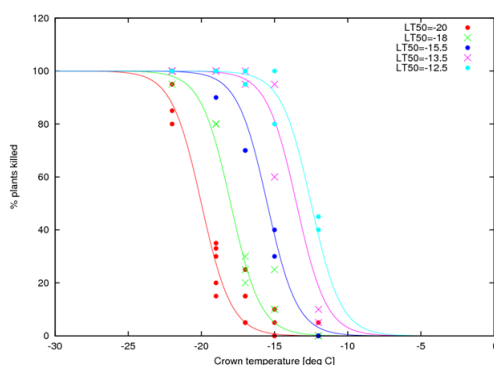

Figure 1. Observations of % of wheat plants being killed for various hardening stages (dots) and logistic models fitted through the points.

Conclusions

A simple logistic model for estimating the number of wheat plants getting killed as a result of low temperatures was developed. This kill function allows to connect the FROSTOL model to the WOFOST model for estimating the impact of frost kill on growth, biomass and yield. Results from the model for sites in Finland and Russia demonstrate satisfactory performance in estimating wheat biomass and yield. Besides the direct killing of plants due to low temperatures in winter, we will look at the occurrence and impact of other effects such as freeze/thaw cycles, ice encasement and conditions for fungal diseases.

References

- Bergjord, A.K., Bonesmo, H. and Skjelvåg, A.O., 2008. Modelling the course of frost tolerance in winter wheat. I. Model development. *European Journal of Agronomy*, 28(3): 321-330.
- Boogaard, H.L., A.J.W. De Wit, J.A. te Roller, C.A. Van Diepen, 2014. WOFOST CONTROL CENTRE 2.1; User's guide for the WOFOST CONTROL CENTRE 2.1 and the crop growth simulation model WOFOST 7.1.7. Wageningen (Netherlands), Alterra, Wageningen University & Research Centre.
- Porter, J. R., & Gawith, M. (1999). Temperatures and the growth and development of wheat: a review. *European Journal of Agronomy*, 10(1), 23-36

Improving crop models by incorporating photosynthetic biochemistry to support crop yield improvement

A. Wu[#] – A. Doherty – G. Hammer*

Centre for Plant Science, Queensland Alliance for Agriculture & Food Innovation, University of Queensland, Level 3, 306 Carmody Road, Queensland Bioscience Precinct
c.wu1@uq.edu.au; * corresponding author: g.hammer@uq.edu.au

Introduction

Genetic manipulation of photosynthesis is being pursued for crop yield improvement (Evans, 2013, Long et al., 2006). Biochemical models of photosynthesis (Caemmerer, 2000) have been used to describe consequences of photosynthetic manipulations on leaf CO₂ assimilation, but not final crop production. Incorporating C₃ photosynthesis model into a crop growth simulation model, (Gu et al., 2014) explained variations in rice crop yields in terms of photosynthetic attributes. The objective of this research is to advance efforts in the incorporation of biochemical models into a crop growth simulation model in the Agricultural Production Systems sIMulator (APSIM), as a mean to support photosynthesis manipulation for crop yield improvement.

Model

At the leaf level, the C₃ photosynthetic biochemical model of Farquhar, von Caemmerer and Berry, (1980), the FvCB model, is extended by coupling it with a stomatal conductance model (Yin and Struik, 2009). Canopy-level assimilation is obtained by dividing the canopy into sunlit and shade leaf fractions (De Pury and Farquhar, 1997). Crop canopy biomass accumulation is calculated from the canopy assimilation less plant growth and maintenance respiration expenditures (Hammer and Wright, 1994). This integrated module is developed using C# and operates on a half-hourly time step. The estimated daily growth from this module is allocated among competing growing organs via the crop growth and development model in APSIM (Fig. 1). Parametrization at the leaf-level photosynthesis is facilitated by recent advances in parameter estimation techniques (e.g. Bernacchi et al., 2002, Yin et al., 2009).

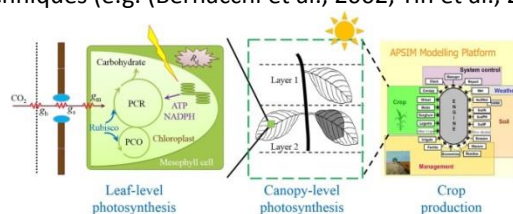

Figure 1. Cross-scale modelling framework for incorporating leaf-level photosynthetic biochemical model into cropping system model. At the leaf level, various aspects of photosynthetic biochemistry is incorporated; upscaling of leaf-level photosynthesis to a canopy level is facilitated by the sunlit and shade leaf framework; canopy-level photosynthesis output is converted to canopy biomass accumulation for input into a cropping system model, which is work in progress.

Results and Discussion

Incorporating the FvCB leaf-level photosynthesis model into a crop model is a necessary step to support genetic manipulation of photosynthesis for crop yield improvement, as it provides a direct link between the genetics underlying photosynthesis and the phenotypic consequences on grain yield of manipulating the genetics. The FvCB model requires parameterisation of various aspects of photosynthetic biochemistry involved, but parameters for key enzymes can be assumed to be conservative among C₃ species. This significantly reduces the number of input parameters required. Preliminary predictions of the cross-scale model indicate that a 15 % increase in Rubisco specificity for CO₂ relative to O₂ generates a 4.5 % increase in daily crop growth.

Conclusions

The cross-scale modelling framework presented here incorporates photosynthesis genetics into a crop growth model. This new tool can be utilized to evaluate and potentially direct genetic manipulation of photosynthesis to improve crop yield. C₄ photosynthesis has also been incorporated using this cross-scale modelling framework.

Acknowledgements

AW and AD acknowledge the Australian Research Council Centre of Excellence for Translational Photosynthesis for the financial support.

References

- Bernacchi C.J., Portis A.R., Nakano H., von Caemmerer S. & Long S.P. (2002) Temperature response of mesophyll conductance. Implications for the determination of Rubisco enzyme kinetics and for limitations to photosynthesis in vivo. *Plant Physiology*, 130, 1992-1998.
- Caemmerer S.v. (2000) Biochemical models of leaf photosynthesis.
- De Pury D.G.G. & Farquhar G.D. (1997) Simple scaling of photosynthesis from leaves to canopies without the errors of big-leaf models. *Plant Cell and Environment*, 20, 537-557.
- Evans J.R. (2013) Improving Photosynthesis. *Plant Physiology*, 162, 1780-1793.
- Farquhar G.D., von Caemmerer S. & Berry J.A. (1980) A biochemical model of photosynthetic CO₂ assimilation in leaves of C₃ species. *Planta*, 149, 78-90.
- Gu J., Yin X., Stomph T.-J. & Struik P.C. (2014) Can exploiting natural genetic variation in leaf photosynthesis contribute to increasing rice productivity? A simulation analysis. *Plant Cell and Environment*, 37, 22-34.
- Hammer G.L. & Wright G.C. (1994) A theoretical-analysis of nitrogen and radiation effects on radiation use efficiency in peanut. *Australian Journal of Agricultural Research*, 45, 575-589.
- Long S.P., Zhu X.-G., Naidu S.L. & Ort D.R. (2006) Can improvement in photosynthesis increase crop yields? *Plant, Cell & Environment*, 29, 315-330.
- Yin X. & Struik P.C. (2009) C-3 and C-4 photosynthesis models: An overview from the perspective of crop modelling. *Njas-Wageningen Journal of Life Sciences*, 57, 27-38.
- Yin X., Struik P.C., Romero P., Harbinson J., Evers J.B., Van Der Putten P.E.L. & Vos J.A.N. (2009) Using combined measurements of gas exchange and chlorophyll fluorescence to estimate parameters of a biochemical C₃ photosynthesis model: a critical appraisal and a new integrated approach applied to leaves in a wheat (*Triticum aestivum*) canopy. *Plant, Cell & Environment*, 32, 448-464.

**Bringing genetics and biochemistry to crop modelling,
and *vice versa***

*X. Yin** – *P. C. Struik*

Centre for Crop Systems Analysis, Department of Plant Sciences, Wageningen University, P.O. Box 430, 6700 AK Wageningen, The Netherlands, * e-mail: Xinyou.Yin@wur.nl

Genetics, biochemistry, and crop modelling are independently evolving disciplines; however, they complement each other in addressing some of the important research questions that crop science faces. One of these research questions is to improve our understanding of crop genotype-to-phenotype relationships in order to assist the development of high-yielding and resource-use efficient cultivars that can adapt to particular (future) target environments.

Crop models are successful in predicting the impact of environmental changes on crop productivity. Applied in the context of plant breeding since the 1970s, these models have been mainly used to propose crop ideotypes, on the premise that model parameters reflecting certain phenological, morphological, and physiological characteristics are under genetic control (Loomis et al., 1979). However, when critically tested against real experimental data, crop models have been shown to be less successful in predicting the impact of genotypic variation and genotype-to-environment interactions exhibited in genetic populations like recombinant inbred line populations (Yin et al., 2000).

In order to better model genotype-to-phenotype relationships in support of breeding programme, crop models need to be improved in terms of both model parameters and model structure. To improve model parameters, again on the general premise that model parameters are under genetic control, the parameters are subjected to genetic analysis such as QTL (quantitative trait locus) mapping (Yin et al., 2000) or directly correlated with the allelic information of known genes (White and Hoogenboom, 1996). The hopes are that individual parameters are under simple, separate genetic control, and that one set of distinct parameters form a genotype (Tardieu, 2003). Achieving this may take several iterations between model parameterization and genetic analysis. Of course, such iterations also involve model structure/algorithm improvement which may yield new parameters or new sets of parameters.

In plant breeding, it is important to be able to identify subtle differences among genotypes exhibited in genetic population in order to perform selection in moving the population mean towards the target phenotypes. Our experiences over the last 15 years in QTL-based crop modelling tell that crop models built upon traditional agronomic and crop physiological concepts can hardly resolve such subtle differences among genotypes. In recent years, genetic engineering approaches to modify crop genome have increasingly been put on the research agenda as the complementary approach to conventional breeding approaches in order to improve crops in greater paces (Long et al., 2015). For the model to deal with the subtle difference in breeding populations as well as to accurately assess the impact of genetic modification on the

biochemical processes, it is required to incorporate the understandings in relevant biochemistry into a crop model framework. Examples for integration of crop modelling, QTL genetics, and biochemical photosynthesis modelling will be outlined, based on the work of Gu et al., (2014a,b) and the ongoing GWAS (genome-wide association study)-based research by Kadam et al., in our group, using an upgraded crop model GECROS.

With genetic information and biochemical understanding incorporated, crop modelling generates new insights and concepts that can in turn be used to improve genetic analysis and biochemical modelling of complex traits. Examples for this retrograde benefit to genetics and to biochemistry will be provided (e.g., Yin et al., 1999; Yin and Struik, 2012).

Given these mutual benefits between crop modelling and fundamental plant biology such as genetics/genomics and biochemistry, we have proposed 'Crop Systems Biology' as the avenue for achieving synergy among these disciplines, also to better assist crop improvement programmes (Yin and Struik 2015).

References

- Gu, J., X. Yin, T.J. Stomph and P.C. Struik (2014a) Can exploiting natural genetic variation in leaf photosynthesis contribute to increasing rice productivity? A simulation analysis. *Plant, Cell and Environment* 37: 22-34.
- Gu, J., X. Yin, C. Zhang, H. Wang and P.C. Struik (2014b) Linking ecophysiological modelling with quantitative genetics to support marker-assisted crop design for improved rice (*Oryza sativa* L.) yields under drought stress. *Annals of Botany* 114: 499-511.
- Long, S.P., A. Marshall-Colon and X.-G. Zhu (2015) Meeting the global food demand of the future by engineering crop photosynthesis and yield potential. *Cell* 161: 56-66.
- Loomis, R.S., R. Rabbinge and E. Ng (1979) Explanatory models in crop physiology. *Annual Review of Plant Physiology* 30: 339-367.
- Tardieu, F. (2003) Virtual plants: modelling as a tool for the genomics of tolerance to water deficit. *Trends in Plant Science* 8: 9-14.
- White, J.W. and G. Hoogenboom (1996) Simulating effects of genes for physiological traits in a process-oriented crop model. *Agronomy Journal* 88: 416-422.
- Yin X., S. Chasalow, C.J. Dourleijn, P. Stam, and M.J. Kropff (2000) Coupling estimated effects of QTLs for physiological traits to a crop growth model: Predicting yield variation among recombinant inbred lines in barley. *Heredity* 85: 539-549.
- Yin, X., M.J. Kropff and P. Stam (1999) The role of ecophysiological models in QTL analysis: the example of specific leaf area in barley. *Heredity* 82: 415-421.
- Yin, X. and P.C. Struik (2012) Mathematical review of the energy transduction stoichiometries of C₄ leaf photosynthesis under limiting light. *Plant, Cell and Environment* 35: 1299-1312.
- Yin, X. and P.C. Struik (editors) (2015) *Crop Systems Biology: Narrowing the Gaps between Crop Modelling and Genetics*. Springer International Publishing Switzerland, in press.

Uncertainty in simulating N uptake and N use efficiency in the crop rotation systems across Europe

X. Yin¹ – K. C. Kersebaum^{2} – C. Kollas³ – C. M. Armas-Herrera⁴ – S. Baby¹ – N. Beaudoin⁴ – M. Bindi⁵ – M. Charfeddine⁶ – T. Conradt³ – I. G. de Cortazar-Atauri⁷ – F. Ewert⁸ – R. Ferrise⁹ – H. Hoffmann⁸ – M. Lana² – M. Launay⁷ – R. Manderscheid¹⁰ – K. Manevski¹ – B. Mary⁴ – W. Mirschel² – M. Moriondo¹¹ – C. Müller³ – C. Nendel² – I. Öztürk¹ – T. Palosuod¹² – D. Ripoche-Wachte⁷ – R. P. Rötter¹² – F. Ruget¹³ – B. Sharif¹ – D. Ventrella⁶ – H.-J. Weigel¹⁰ – J. E. Olesen^{1*}*

* Corresponding authors' email: ckersebaum@zalf.de; jeo@agro.au.dk

Introduction

Nitrogen use efficiency is becoming of increasing concern globally to ensure higher agricultural production with less fertilizer inputs. How to improve N use efficiency has been of increasing concern for scientists, policy makers and farmers. Crop models provide an explicit representation of N flows, transformations and crop uptake (Walach et al., 2006). Previous studies have demonstrated that the multi-model mean of simulations is a better estimator of mean crop yield than any single-model simulations (Asseng et al., 2013), but less is known on how multi-model ensembles perform for simulating N uptake. Furthermore, there are no reports about multi-model ensemble simulations in N uptake in the crop rotation systems across Europe. Therefore, the aim of the study is (1) to evaluate the model performance in simulating crop N uptake in crop rotation systems across Europe within different calibration levels; (2) to assess the model ensemble effects in predicting N uptake; (3) to investigate different management effects on N uptake and N use efficiency.

Materials and Methods

Experimental data

Five experimental crop rotation datasets, each containing a different set of treatments, were selected for the present study, which were well depicted in the latest publication of MACSUR Rotation Effects work (Kollas et al., 2015). Two N uptake parameters were selected in the study, including N in storage organ (grain N) and N in residues above ground (residue N), which was equivalent to N in crop biomass minus N in storage organ in storage organ.

Crop models and simulation modes

Nine European modelling teams participated in the present study. SWIM performed continuous runs only, i.e. simulating the multi-year datasets without reinitializing sub-routines at the onset of each growing season, called ROTATION runs. DSSAT performed single-season crop growth only, i.e. they simulated each crop in the rotation separately, called SINGLE runs. DAISY, FASSET, HERMES, LINTUL2, MONICA and STICS provided results for both ROTATION and SINGLE. There were two kinds of outputs based on the different calibration levels in the study, i.e. the minimal calibration outputs (Kollas et

al., 2015) and the full calibration outputs, the later full calibration means that modelers calibrated their models with much more observation data including grain N and crop N for specific crops at each experimental site.

Evaluation of model performance

The mean of all model simulations (e-mean) was used to evaluate the multi-model ensembles. In order to evaluate the model performance in simulating N uptake, we applied the following four statistical measures and indices based on the comparison of simulations and observations, including the model efficiency (ME), the percent bias (PBIAS), the root mean square error (RMSE) and coefficient of determination (r^2). Furthermore, the apparent recovery efficiency of applied N (RE_N) and the physiological efficiency of applied N (PE_N) were used in the study to indicate N use efficiency.

Results and Discussion

The study include the following four parts: 1. Model performance in simulating grain N and residue N in the crop rotation systems across Europe, which included both SINGLE and ROTATION simulations under both minimal and full calibration; 2. Multi-model ensemble simulation of both grain N and residue N, which also considered both different simulating modes and calibration levels; 3. Simulating management effects on N uptake across Europe, only based on full calibration, including a) N application and CO₂ concentration effects, b) N application and catch crop effects, c) Soil and residue effects, d) Irrigation and climate effects; 4. The effects of atmospheric CO₂ concentration and catch crop on NUE.

Conclusions

Preliminary analyses indicate that both ROTATION and SINGLE models performed better under full calibration than minimum calibration in simulating both grain N and residue N. ROTATION modes performed better in simulating grain N than SINGLE modes, especially for the main crops, i.e. winter wheat, winter barley, sugar beet and pea.

Acknowledgements

We greatly appreciate all the modelers that participated in the MACSUR Crop Rotation work, as well all the experimenters involved in providing the experimental results.

Vulnerability of grain maize yield under meteorological droughts: a comparison of commercial and subsistence farms in South Africa

G. Zhao¹ – M. Hoffmann² – J. Schellberg³

¹ Crop Science Group, Institute of Crop Science and Resource Conservation (INRES), University of Bonn, Katzenburgweg 5, 53115 Bonn, Germany

² Crop Production Systems in the Tropics, Georg-August-Universität Göttingen, Grisebachstr. 6, 37077 Göttingen, Germany

³ Agro- and Production Ecology, Institute of Crop Science and Resource Conservation (INRES), University of Bonn, Melbweg 42, 53115 Bonn, Germany

Introduction

As a frequent happening natural hazard, drought is continuously endangering the food production and security of South Africa. This study assesses the vulnerability of grain maize yield to meteorological droughts of three different severities, and compares the vulnerability between subsistence and commercial farms.

Materials and Methods

The commercial and subsistence farms were distinguished by South Africa National Land-Cover Change Map 2000 (Figure 1). Gridded daily weather (1955-2010, ~25 km resolution) and soil data (1 km resolution) were used to drive APSIM (Keating et al., 2003) to simulate the grain maize yields under rainfed conditions. Simulation setup for subsistence and commercial farms differed by nitrogen application rates (0 kg N ha⁻¹ versus N rates vary with rainfall), planting density (3 plant m⁻² versus density vary with rainfall) and residue management (removal versus retention). The Standard Precipitation Index (SPI, McKee et al., 1993) was used to quantify the spatial-temporal variability and severity of meteorological droughts. The simulated phenology and leaf area index were validated against remote sensing data (MODIS MCD15A3). Spatial and temporal variability of simulated was validated against province and district yield statistics. We used the probabilistic-based method presented by van Oijen et al., (2013) to quantify the vulnerability as the yield difference between drought and normal years:

$$Vulnerability_i = E(Yield|normal) - E(Yield|drought_i) \quad (1)$$

where i denotes the moderate ($-1.5 < SPI < -1$), severe ($-2 < SPI < -1.5$) and extremely ($SPI < -2$) droughts.

Results and Discussion

APSIM captured the spatial-temporal variability of maize yields comparing to the yield statistics at province and district levels. It also simulated reasonable phenology and leaf area index (LAI) comparing to the MODIS LAI products. Under moderate drought, the vulnerability of maize yield under subsistence dryland (0.6 t ha⁻¹) farming practices

was lower than commercial ones (0.8 t ha^{-1}) (Figure 1), while it became larger under extreme drought (1.2 t ha^{-1} for subsistence and 1.1 t ha^{-1} for commercial). Since commercial farms applied higher N, the expected return was also higher, which resulted in its high vulnerability under moderate drought. The risk associated with higher input depicts a challenge to the currently promoted intensification strategy by the government. The discovered strong spatial and temporal variability can potentially be used to find adaptive management practices.

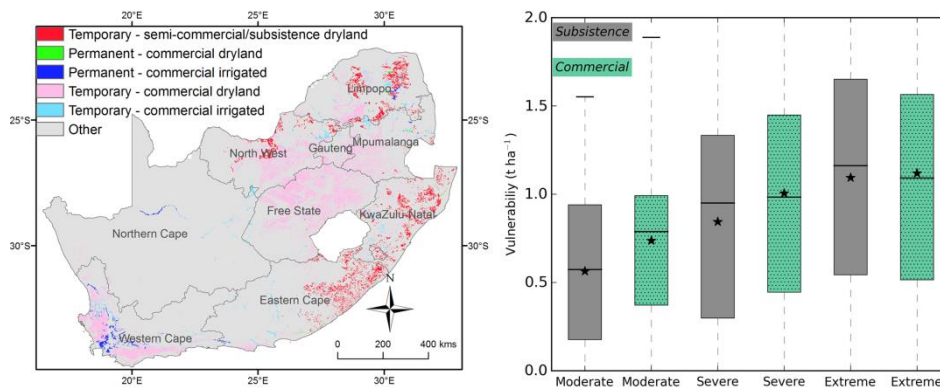

Figure 1. Land use of the study area and vulnerability of maize yields under different drought severities (moderate, severe and extreme) for two farm types (gray for subsistence and dotted green for commercial).

Conclusions

The mean yield in subsistence farms can be improved by increasing N application and residue retention without increasing vulnerability, indicating that water availability is of less importance when compared to nutrient limiting factors.

Acknowledgements

This study is supported by the German Federal Ministry of Education and Research (BMBF) through the SPACES project "Living Landscapes Limpopo" project.

References

- Keating, B.A. et al., (2003). An overview of APSIM, a model designed for farming systems simulation. *European Journal of Agronomy* 18, 267-288.
- McKee, T.B., et al., (1993). The relationship of drought frequency and duration to time scales, *Proceedings of the 8th Conference on Applied Climatology*. American Meteorological Society Boston, MA, pp. 179-183.
- van Oijen et al., (2013). A novel probabilistic risk analysis to determine the vulnerability of ecosystems to extreme climatic events. *Environmental Research Letters* 8, 015032.

Integrating xylem and phloem fluxes into whole-plant models for simulating fleshy fruits

J. Zhu^{1*} – *Z. Dai*¹ – *P. Vivin*¹ – *G. Gambetta*² – *N. Ollat*¹ – *M. Henk*³ – *S. Delrot*⁴

¹ INRA, Université de Bordeaux, ISVV UMR 1287 EGFV, 33140 Villenave d'Ornon, France

² Bordeaux Sciences Agro, ISVV, INRA, UMR 1287 EGFV, 33140 Villenave d'Ornon, France

³ Department of Ecoinformatics, Biometrics and Forest Growth, University of Göttingen, 37077 Göttingen, Germany

⁴ Université de Bordeaux, ISVV, INRA, UMR 1287 EGFV, 33140 Villenave d'Ornon, France

* Correspondance: junqi.zhu@bordeaux.inra.fr

Introduction

The expansion of fleshy fruit is mainly driven by processes related with water and sugar fluxes, which are mediated by mechanisms of xylem water transport and phloem loading and unloading. Despite the importance of xylem water potential and phloem sugar concentration in regulating water and sugar fluxes, they have rarely been incorporated into plant models. Here we present a novel functional-structural grapevine (*Vitis vinifera* L.) model which integrates xylem water and phloem sugar fluxes focused on berry development.

Materials and Methods

A new grapevine model was constructed in the plant modelling software GroIMP (Kniemeyer, 2008). The model integrated the current most advanced algorithms on: 1) coupling of photosynthesis and transpiration (Yin and Struck, 2009); 2) coordination of stomatal aperture, abscisic acid (ABA), transpiration and root conductance (stomata-ABA-root conductance module, Tardieu et al., 2015); 3) balance of sugar loading and unloading via phloem sugar concentration (Bladazzi et al., 2013); 4) fruit growth (Fishman and Genard, 1998); 5) nitrogen economy model within plant architecture (Bertheloot et al., 2011); 6) their interactions and feedback mechanisms.

The model simulates the potential individual leaf photosynthesis, transpiration, and temperature as a mutually dependent process. The potential stomata conductance resulting from this mutually dependent process was used as an input into the stomata-ABA-root conductance module in order to estimate the real stomata conductance. The actual transpiration, leaf temperature and photosynthesis were updated, in sequence, based on the actual stomata conductance. The sum of leaf transpiration together with soil water potential was used for estimating root conductance and root water potential (considered as xylem water potential because the resistance of the wood and internode for water flux are very small). The leaf nitrogen content was updated based on the rate of N synthesis (related with individual leaf transpiration) and the rate of N degradation. The phloem sugar concentration was calculated based on the balance between the loading of leaf, internode, and wood and the unloading of berry, root, internode and wood.

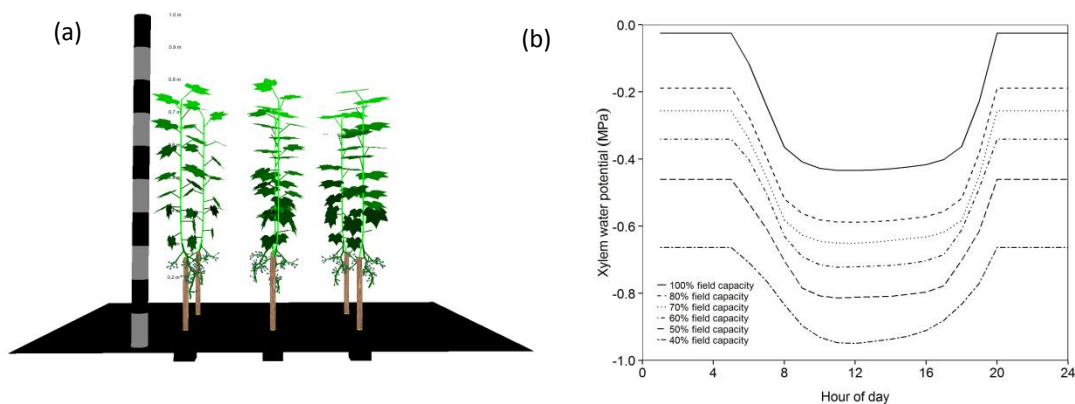

Figure 1. Visualization of the grapevine model at veraison (panel a) and the simulated diurnal change of xylem water potential at various soil water contents expressed as fraction of field capacity (panel b).

The color gradient of the leaf in panel (a) represents the proportion of absorbed radiation (from black, low absorbed radiation, to light green, high absorbed radiation).

Results and Discussion

The model produces accurate diurnal changes in photosynthesis and water flux as compared to observations at different soil water contents and various light intensities. The model simulations showed that water stress and shading both reduce the carbon assimilation but affects differently on berry sugar concentration. Water stress reduces the xylem water potential and thus decreases the berry water import, while shading increases xylem water potential and thus increases the berry water import.

Conclusions

An innovative whole-plant grapevine model which integrates xylem and phloem fluxes has been developed. The model can be used to assess the influence of environmental conditions, management practices, and plant traits on the rate of water and sugar accumulation by the berry.

Acknowledgements

We thank Drs Jochem B. Evers, Xinyou Yin, Francois Tardieu, Jessica Bertheloot for sharing their model codes, and Drs Bruno Andrieu, Romain Barillot, Gilles Vercambre, Michel Genard, Eric Lebon for helpful discussions. We greatly acknowledge the financial support of the INNOVINE project, grant agreement no.FP7-311775.

References

- Baldazzi, V., A. Pinet, G. Vercambre, C. Benard, B. Biais and M. Genard (2013). *Frontiers in Plant Science* 4.
- Bertheloot, J., P.-H. Cournède and B. Andrieu (2011). *Annals of Botany* 108(6): 1085-1096.
- Kniemeyer, O. (2008). PhD thesis, Brandenburg University of Technology.
- Tardieu, F., T. Simonneau and B. Parent (2015). *Journal of Experimental Botany* 66 (8): 2227-2237..
- Yin, X. and P. C. Struck (2009). *NJAS - Wageningen Journal of Life Sciences* 57(1): 27-38.

Abstracts of Poster Presentations

Potential substitution of mineral p fertilizer by manure: epic development and implementation

*L. B. Azevedo*¹ – *P. A. Vadas*² – *J. Balkovič*^{1,3} – *R. Skalský*^{1,4} – *C. Folberth*^{1,5} – *M. van der Velde*⁶ – *M. Obersteiner*¹

¹ Ecosystems Services and Management Program, International Institute for Applied Systems Analysis (IIASA), Scholssplatz 1, 2361 Laxenburg, Austria, azevedol@iiasa.ac.at

² Dairy Forage Research Center, USDA-ARS, United States

³ Department of Soil Science, Faculty of Natural Sciences, Comenius University, Slovak Republic

⁴ National Agricultural and Food Centre, Soil Science and Conservation Research Institute, Slovak Republic

⁵ Department of Geography, Ludwig Maximilian University, Germany

⁶ Institute for Environment and Sustainability, European Commission, DG JRC, Italy

Introduction

Sources of mineral phosphorus (P) fertilizers are non-renewable. Although the longevity of P mines and the risk of future P depletion are highly debated (Cordell et al., 2009; van Vuuren et al., 2010), P scarcity may be detrimental to agriculture in various ways. Some of these impacts include increasing food insecurity and N and P imbalances (Peñuelas et al., 2013; van der Velde et al., 2014), serious fluctuations in the global fertilizer and crop market prices (Obersteiner et al., 2013), and contribution in geopolitical conflicts (Cordell et al., 2009).

P-rich waste produced from livestock production activities (i.e. manure) are an alternative to mineral P fertilizer. The substitution of mineral fertilizer with manure (1) delays the depletion of phosphate rock stocks, (2) reduces the vulnerability of P fertilizer importing countries to sudden changes in the fertilizer market, (3) reduces the chances of geopolitical conflicts arising from P exploitation pressures, (4) avoids the need for environmental protection policies in livestock systems, e.g. milk quotas in the Netherlands (Boere et al., 2015), (5) is an opportunity for the boosting of crop yields in low nutrient input agricultural systems, and (6) contributes to the inflow of not only P but also other essential nutrients to agricultural soils.

Materials and Methods

The Environmental Policy Integrated Climate model (EPIC) (Williams 1995) is a widely used process-based, crop model integrating various environmental flows relevant to crop production as well as environmental quality assessments (Balkovič et al., 2014; Elshout et al., 2015). We simulate crop yields using a powerful computer cluster infrastructure (known as EPIC-IIASA) in combination with spatially-explicit EPIC input data on climate, management, soils, and landscape. EPIC-IIASA contains over 131,000 simulation units and it has 5 arc-min resolution (Skalský et al., 2008).

EPIC encompasses a fairly rudimentary manure routine whereby P can be recycled from manure storage back to the soil depending on the animal density specified by the model user. Another option within EPIC is to apply manure as fertilizer. Both options do not consider biogeochemical processes taking place before nutrients are

transferred to the soil within the manure compartment, including losses of nutrients to the environment. In this work, we implement two process-based models of manure biogeochemistry into EPIC-IIASA, i.e. SurPhos (for P) (Vadas et al., 2007; Vadas et al., 2011) and Manure DNDC (for N and carbon) (Li et al., 2012) and a fate model model describing nutrient outflows from fertilizer via runoff (Vadas et al., 2008), Figure 1.

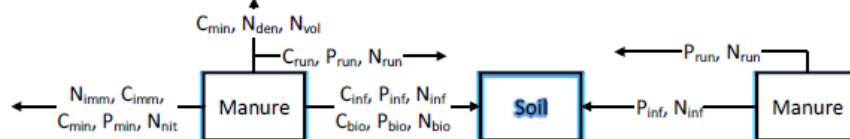

Figure 1. Biogeochemical processes described in previous works (Vadas et al., 2007; Vadas et al., 2008; Vadas et al., 2011; Li et al., 2012) and implemented into EPIC. Nitrogen (N), phosphorus (P), and carbon (C) processes include mineralization (min), denitrification (den), volatilization (vol), runoff (run), infiltration (inf), bioturbation (bio), nitrification (nit), and immobilization (imm).

Results and Discussion

For iCROP2016, we will use EPIC-IIASA to quantify what is the potential of mineral P fertilizer substitution with manure. Specifically, we will estimate the relative increase (or decrease) in crop yields under mineral P depletion scenarios and the intensification of manure use as an alternative P input for the major crops (i.e., wheat, barley, rye, rice, maize, and potatoes). This work will take into account existing estimates of livestock population densities (Robinson et al., 2011), existing manure recycling technologies (Sommer et al., 2013), and transportation costs.

Acknowledgements

This work is funded by the European Research Council Synergy grant ERC-2013-SynG-610028 IMBALANCE-P.

References

- Balkovič, J., M. van der Velde, et al., (2014). *Global and Planetary Change* 122(0): 107-121.
 Boere, E., J. Peerlings, et al., (2015). *European Review of Agricultural Economics*.
 Cordell, D., J. O. Drangert, et al., (2009). *Global Environmental Change* 19(2): 292-305.
 Elshout, P. M. F., R. van Zelm, et al., (2015). *Nature Clim. Change* 5(6): 604-610.
 Li, C., W. Salas, et al., (2012). *Nutrient Cycling in Agroecosystems* 93(2): 163-200.
 Obersteiner, M., J. Penuelas, et al., (2013). *Nature Geosci* 6(11): 897-898.
 Peñuelas, J., B. Poulter, et al., (2013). *Nat Commun* 4.
 Robinson, T. P., T. P.K., et al., (2011). *Global livestock production systems*. Rome, Food and Agriculture Organization of the United Nations (FAO), International Livestock Research Institute (ILRI).
 Skalský, R., Z. Tarasovičová, et al., (2008). *Laxenburg, International Institute for Applied Systems Analysis*.
 Sommer, S. G., M. L. Christensen, et al., (2013). *Animal Manure Recycling: Treatment and Management*.
 Vadas, P. A., S. R. Aarons, et al., (2011). *Soil Research* 49(4): 367-375.
 Vadas, P. A., W. J. Gburek, et al., (2007). *Journal of Environmental Quality* 36(1): 324-332.
 Vadas, P. A., L. B. Owens, et al., (2008). *Agriculture, Ecosystems and Environment* 127(1-2): 59-65.
 Van der Velde, M., C. Folberth, et al., (2014). *Global Change Biology* 20(4): 1278-1288.
 Van Vuuren, D. P., A. F. Bouwman, et al., (2010). *Global Environmental Change* 20(3): 428-439.
 Williams, J. R. (1995). *The EPIC model. Computer Models of Watershed Hydrology*. V. P. Singh. Colorado, Water Resources Publisher: 909-1000.

Typologies of drought and heat stress scenarios at european level for wheat

B. Ababaei^{1,2,3} – *J. Derory*³ – *P. Martre*^{1,2}

¹ INRA, UMR759 Laboratoire d'Ecophysiologie des Plantes sous Stress Environnementaux, F-34 060 Montpellier, France, e-mail: pierre.martre@supagro.inra.fr

² Montpellier SupAgro, UMR759 Laboratoire d'Ecophysiologie des Plantes sous Stress Environnementaux, F-34 060 Montpellier, France

³ Limagrain Europe, Native Trait Genetic Resources and Pre-breeding, F-63 720 Chappes, France

Introduction

Breeders have always been trying to find genotypes adapted to target environment which has been essential to recent developments in crop yield improvement. However, they are challenged for (1) adaptation across the target population of environments (TPE; i.e. the set of environments in which cultivars can be grown within the geographical area targeted by a breeding program) (Comstock, 1977) and (2) adaptation to specific types of environments within the TPE (Löffler et al., 2005; Dreccer et al., 2007). Numerous methodologies have been developed to characterize the complete TPE which use soil and climate data (e.g. Hodson and White, 2007), integrated traits like yield or anthesis date (e.g. Hernandez-Segundo et al., 2009), and stress indices simulated by crop models (e.g. Chenu et al., 2013). Considering the cost limitation of conducting the characterization of trial networks based on check-variety performance, crop models offer a more comprehensive environmental sampling and can account for genotype × environment (G×E) interactions and allow more detailed interpretation of G×E interactions (Chenu et al., 2011).

The main objective of this study is to produce typologies of drought and heat stresses confronted by wheat across Europe. The goals are to (1) characterize the typology of the drought and heat stresses scenarios occurring in TPEs, (2) analyze the frequency of the main environment types (ETs across Europe over a long period), (3) analyze G×E interactions, and (4) analyze changes in drought and heat stress scenarios and modifications of the TPE landscape due to recent climate change.

Materials and Methods

A grid-based (25×25 km) analysis of drought and heat stress scenarios for wheat was carried out at the European level using indices calculated by the *SiriusQuality2* wheat crop model (<http://www1.clermont.inra.fr/siriusquality>). Weather, soil and agronomic data were obtained from various sources, including the JRC Agri4Cast Data Portal and AgroPheno database, the Harmonized World Soil Database (HWSD), the European Soil Database (ESDBv2.0). The parameterizations of flowering and harvest times for widely grown European wheat cultivars were selected for each NUTS2 (Nomenclature of Territorial Units for Statistics) region by comparing simulated phenological stages with that reported in the AgroPheno database at the grid level. A framework was developed

which enables to extract required input data, run the simulations, extract the target outputs and perform statistical analyses.

Model performance were assessed by comparing simulated grain yield aggregated at NUTS2 level with grain yield reported in the EuroStat database. Besides water deficit indices based on a supply-demand approach and heat stress indices based on cumulative days with a maximum daily temperature above a threshold value during critical growth periods, we derived an integrated stress index that decompose the effect of water deficit, above optimum temperature for wheat growth, and nitrogen deficit and their interactions on daily biomass accumulation. All indices were calculated daily to determine their level and frequency of occurrence and the developmental stage at which they apply. A global clustering approach was used to reduce the TPE to a limited number of ETs. The frequency of stress patterns were assessed at various spatial scales and the main stress scenarios (i.e. ETs) were identified.

Results and Discussion

A typology of drought and heat stresses scenarios and their frequency of occurrence at various spatial and temporal scales were obtained. This typology should be the basis for the analysis of what are the key environmental variables for describing drought and heat stresses to be included in G×E studies, and for analyzing the putative impact of adaptive traits in different ETs.

Conclusions

An ensemble of grid-based crop simulations were used to study the relative importance of drought and heat stresses (and their interactions) to the performance of wheat across Europe. The proposed approach to consider the independent and combined impacts of drought, heat and nitrogen stresses is an innovative way to study the relative importance of stresses of various nature to crop performance in different environments.

Acknowledgements

We thank Dr. Lorenzo Seguíni (JRC, Ispra, Italy) for sharing phenological data from the AgroPheno database.

References

- Fredriksen, F. and G. Göransson (2004). Black Soil Publishing, Magdeburg, 220 pp.
- Comstock, R.E. (1977). Quantitative genetics and the design of breeding programs. In: Pollack E., O, Kempthorne, T.B. Bailey, eds. Proceedings of the international conference on quantitative genetics. Iowa State University Press, Ames, USA, 705-718.
- Löffler, C.M., J. Wei, T. Fast, et al., (2005). *Crop Science*, 45: 1708-1716.
- Dreccer, M.F., M.G. Borgognone, F.C. Ogbonnaya, et al., (2007). *Field Crops Research*, 100: 218-228.
- Hodson, D.P., and J.W. White (2007). *Journal of Agricultural Science*, 145: 115-125.
- Hernandez-Segundo, E., F. Capettini, R. Trethowan, et al., (2009). *Crop Science*, 49: 1705-1718.
- Chenu, K., R. Dehmfard, and S.C. Chapman (2013). *New Phytologist*, 198: 801–820.

Monitoring and prediction climate changes for maize yield using aquacrop model and cmip5 data

*M. J. Ahmadi*¹ – *N. Nakhjavani*² – *N. Salehnia*³

¹ Water engineering, Agriculture, Ferdowsi university of Mashad, Iran, Mashad, Park Square, e-mail: Mohamad_ahmadi@yahoo.com

² Water engineering, Agriculture, Ferdowsi university of Mashad

³ Water engineering, Agriculture, Ferdowsi university of Mashad

Introduction

Considering the adversity of water crisis in arid and semi-arid regions, agricultural industry has always been facing limitations in these areas. Recently, simulated models of plant growth have been developed to be used to optimize water consumption in various plants. AquaCrop is an efficient model to improve water consumption management. Along with scientific and experimental developments in water and plant relationship from 1979, FAO presented its 33 publication in the form of AquaCrop model.

Materials and Methods

The object of current research is to investigate the best condition for maize cultivation with the usage of AquaCrop model which the maize yield in 20 years (1993-2013) simulated. Also, the consequences of MIROC4H model of CMIP5 with RCP45 scenario outcome have been used to scrutinize the changes of maize performance in 20 years (2015-2035). This research was done in the research land of Ferdowsi university in 2013. Irrigation method is of surface method and irrigation treatments are complete irrigation (W1), 80% FC (W2), 60% FC (W3), 50% FC (W4) and irrigation period is 7 days long. To evaluate the efficiency and error of the model, MAE, RMSE, E and R² statistical parameters have been utilized.

Results and Discussion

Some information like water productivity (WP), irrigation water, biomass and grain yield are mentioned in the following Figure 1:

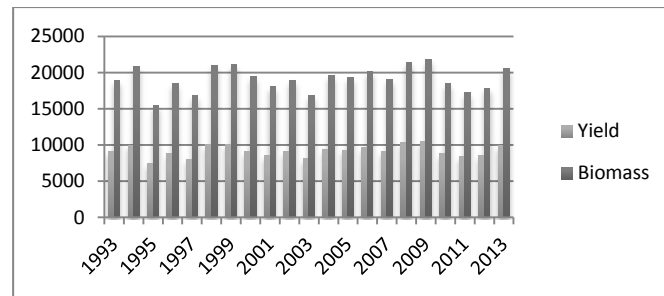

Figure1

To calibrate the model. Field experiment measured data has been used in 2013 under various treatments whose consequences are mentioned in Table 1 :

Table 1

Treatment	Yield (obs) kg/ha	Yield (sim) kg/ha	Biomass (obs) kg/ha	Biomass (sim) kg/ha
W1	9067	9881	20623	20557
W2	5840	6047	14961	15046
W3	3914	3215	12514	12303
W4	2771	2496	11718	11522

Calibration results under various irrigation and moderate fertilized indicate the simulation high accuracy of AquaCrop model for maize crop. According to the model calibration, statistical parameters E, MAE, RMSE, R2 are, in order, equal to 0.91, 0.11, 0.44, 0.97-0.99. With MIROC4H outputs, according to the results, amount of yield in thirty years is indicative of climate change in Mashhad plain. Studies showed that the average performance (1993-2013) and 20-year forecasts (2015-2035) of 2009.405 kg per hectare.

Conclusions

Crop yield is one of the important variables associated with climate change in every part of world and the amount of climatic variables within every scale of time (week or month) varies widespread. Use of different crop models can help to find out the changes of crop yield in every period(now,past and future), one of them is AquaCrop. CMIP5 models can draw a strong projection of future changes.

References

- Steduto, P., T.C. Hsiao, D. Raes, E. Fereres. (2009). AquaCrop-The FAO crop model to simulate yield response to water: I Concepts and Underlying Principles. J. Agron. 101: 426-437.
- Steduto, P. (2003). Biomass water-productivity. Comparing the growth-engines of crop models. FAO expert consultation on crop water productivity under deficient water supply, 26-28 February 2003, Rome, Italy.
- M.Abedinpour, A.Sarangi, T.B.S.Rajput, Man Singh, H.Pathak,T.Ahmad. (2011). Performance evaluation of AquaCrop model for maize crop in a semi-arid environment, India.

Assessment of climate change impacts on winter wheat in the US Pacific Northwest using a multimodel ensemble approach

M. Ahmed^{1,2} – *C. O. Stöckle*¹ – *R. Nelson*¹ – *S. Higgins*¹

¹ Biological Systems Engineering, Washington State University, Pullman, WA 99164-6120, e-mail: mukhtar.ahmed@wsu.edu, ahmadmukhtar@uaar.edu.pk

² Department of Agronomy, PMAS Arid Agriculture University Rawalpindi-46300, Pakistan

Introduction

Climate change is a major concern for crop productivity, with the chief contributing factors including rising temperature, modified frequency of extreme events, and elevated CO₂. The assessment of climate change impacts on agriculture has been often conducted using a combination of weather derived from general circulation models (GCM) and crop responses evaluated with cropping systems models (CSM), typically one crop model and a few GCM projections. This type of approach has been applied to the US Pacific Northwest (PNW) with projections suggesting mostly beneficial effects of climate change on wheat production (e.g., Stockle et al., 2010). However, recent studies (e.g., Asseng et al., 2013) are finding significant variations in both GCM and CSM projections, introducing significant uncertainty in these assessments. The purpose of this study was to use a multimodel ensemble to assess the direction and uncertainty of changes in winter wheat yields in the PNW.

Materials and Methods

Seven diverse agro-ecological sites in the main dryland winter wheat production region of the Inland PNW were used, and simulations were performed using five cropping system models (APSIM, CropSyst, DSSAT, EPIC, and STICS) and fourteen GCMs under two Representative Concentration Pathways (RCP): RCP4.5 and 8.5. Projection uncertainty associated with GCMs and CSMs was evaluated using sums of squares generated from ANOVA, and an ensemble of GCMs and CSMs was used to project climate change impacts on winter wheat yields.

Results and Discussion

A large variation among GCMs and CSMs projections was found, resulting in important differences in predicted future winter wheat yields. An uncertainty index (UI)

Table 1. Uncertainty Index (UI) generated from ANOVA sums of squares (SS) for winter wheat yield showing uncertainty among treatments combined over RCPs and sites

SOV	2030		2050		2070	
	SS	UI	SS	UI	SS	UI
GCMs	1.896	0.011288	5.072	0.020615	14.489	0.048226
CSMs	144.101	0.857938	194.783	0.791695	213.319	0.710029
GCMs*CSMs	14.417	0.085835	25.727	0.104567	34.779	0.115761
Error	7.548	0.044939	20.452	0.083127	37.85	0.125983
Total	167.962		246.033		300.437	

determined from ANOVA sums of squares (Table 1) revealed that uncertainty was more prominent among crop models compared to GCMs for three time periods (2030, 2050 and 2070). Despite this uncertainty, an ensemble of all GCMs and CSMs showed a consistent trend of beneficial effects of climate change on wheat yields in all sites studied (Figure 1).

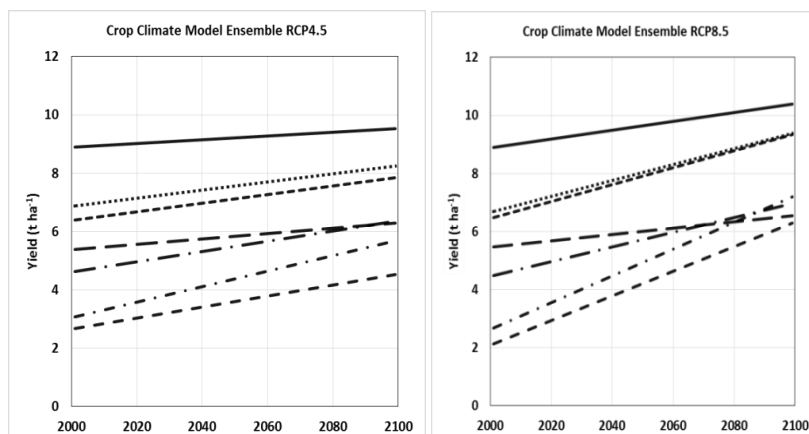

Figure 1. Winter wheat yield trend by crop climate model ensemble approach using two RCPs (RCP4.5 and 8.5) at seven diverse agro-ecological sites (..... Cook, ---- Kambitsch, -.- Lind, -.-.- Moro, — Moses Lake, — • Wilke, — * Saint John) of the Pacific Northwest USA

Conclusions

Uncertainty in climate change impact assessments due to the variability of GCMs and CSMs projections can be substantial, with the uncertainty attributed to CSMs being the largest in this study. Results from a multimodel ensemble validated previous projections in the region conducted using one crop model and a small number of GCMs.

Acknowledgements

This study was supported by the United States Department of Agriculture NIFA (grant no: BJKL03SB002. Approaches to climate change for inland Pacific Northwest agriculture).

References

- Asseng, S., Ewert, F., Rosenzweig, C., Jones, J.W., Hatfield, J.L., Ruane, A.C., Boote, K.J., Thorburn, P.J., Rotter, R.P., Cammarano, D., Brisson, N., Basso, B., Martre, P., Aggarwal, P.K., Angulo, C., Bertuzzi, P., Biernath, C., Challinor, A.J., Doltra, J., Gayler, S., Goldberg, R., Grant, R., Heng, L., Hooker, J., Hunt, L.A., Ingwersen, J., Izaurralde, R.C., Kersebaum, K.C., Muller, C., Naresh Kumar, S., Nendel, C., O'Leary, G., Olesen, J.E., Osborne, T.M., Palosuo, T., Priesack, E., Ripoche, D., Semenov, M.A., Shcherbak, I., Steduto, P., Stockle, C., Stratonovitch, P., Streck, T., Supit, I., Tao, F., Travasso, M., Waha, K., Wallach, D., White, J.W., Williams, J.R., Wolf, J. (2013). Uncertainty in simulating wheat yields under climate change. *Nature Clim. Change* 3, 827-832.
- Stöckle, C.O, Nelson, R.L., Higgins, S, Brunner, J., Grove, G., Boydston, R., Whiting, M, Kruger, C. (2010). Assessment of climate change impact on eastern Washington agriculture. *Climatic Change* 102:77-102.

In-season forecast of crop yields, soil water-nitrogen, and WEATHER using apsim and wrf models in iowa, usa

S. Archontoulis – M. Licht – R. Dietzel – M. Castellano – A. van Loocke – K. Moore – C. Cordova – L. Puntel – K. Togliatti – I. Huber*

Department of Agronomy, Iowa State University, Ames, Iowa, USA, e-mail: sarchont@iastate.edu

Introduction

Forecasting crop yield and water-nitrogen dynamics over crop growth cycles can greatly assist in-season decision making process. Common approaches include use of statistical or mechanistic simulation models, aerial images, or combinations of these to make the predictions. Different approaches and models have different capabilities, strengths, and limitations. However, detailed protocols on how to conduct an in-season forecast are rare in literature. Here we present our methodology and discuss the results of a project aimed at forecasting weather, soil water-nitrogen status, crop water-nitrogen demand, and end-of-season crop yields in Iowa using two process-based simulation models.

Materials and Methods

We combined a climate model (WRF, <http://www.wrf-model.org/index.php>) that provided a 14-day weather forecast with the capabilities of APSIM (Holzworth et al., 2014) to synthesize soil-crop-climate information and create in-season forecasts for 8 cropping systems: 2 crops, corn and soybean; 2 sites, central and northwestern Iowa; and 2 planting dates, early and late. The crops were managed using typical crop management practices for Midwest US. High resolution measurements were taken from replicated plots. Measurements included hourly soil water and temperature at three depths, hourly groundwater table measurements, weekly soil NO₃-N and NH₄-N measurements from April to October, and 10 in-season destructive crop harvests to estimate phenology, biomass production and partitioning, tissue N concentration, and leaf area index. As of 15 September 2015, eight in-season forecasts were released bi-weekly via a website (<http://agron.iastate.edu/CroppingSystemsTools/>) to a group of 80 Iowa State University Extension faculty and staff to evaluate the project and make use of the in-season information. In each forecast, we provided both in-field measurements and model predictions. To set up APSIM (model initial conditions, cultivars, etc.) in the experimental plots, we leveraged results from previous model calibration studies in Iowa (Archontoulis et al., 2014a,b; Dietzel 2015).

Results and Discussion

Figure 1 shows results for early planted corn and soybean cropping systems in Ames. Over the growing season APSIM accurately simulated plant and soil components, which is an indication that the simulation of crop water-nitrogen use throughout the season was accurate. However, the accuracy of the 14-day crop demand prediction

was more dependent upon the accuracy of the weather prediction, which in general was good. The uncertainty with the end-of-season yield prediction (10%, 50%, and 90% of yield being above) was large at the beginning of season, became smaller during the season, and converged to a single value near crop maturity. This converged yield prediction is very close to observed grain yields. Our results will be further validated against the final crop harvests in October 2015. External participants indicated that the system-level forecast was very informative for in-season decision making as well as for educational purposes. The main challenges faced in this first year were: 1) simulation of shallow groundwater tables (80 to 150 cm) that affects root growth, water uptake, and N budgets, 2) quality of historical weather data, 3) coordination of the information flow (from field to simulation to webpage), and 4) selection of results to provide publicly.

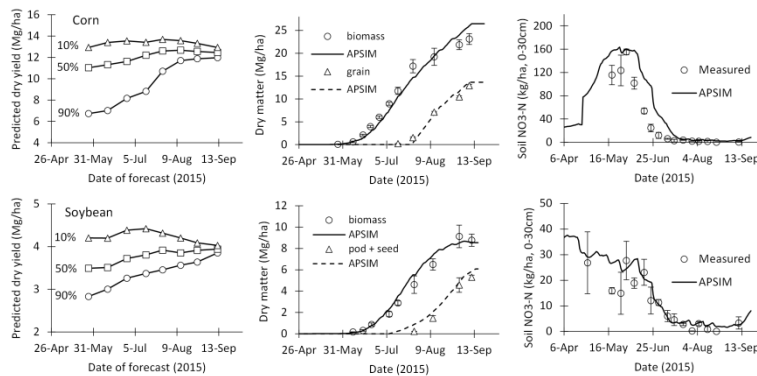

Figure 1. Preliminary results as of 15 September 2015 for Ames, Iowa. Top panels: corn planted on 23 April 2015 with 8 seeds/m² and 168 kg/ha nitrogen fertilization at planting. Bottom panel: soybean planted on 23 April 2015 with 35 seeds/m². Left panels: In-season yield predictions showing 10%, 50%, and 90% probability of yield being above; Middle and right panels: Biomass, yield, and NO₃-N measurements and predictions.

Conclusions

We conclude that a system-level forecast via a combination of process-based models provides valuable in-season information. However, a good knowledge of the fields (crop history and soils) and cultivar characteristics are needed for accurate forecasts.

Acknowledgements

We thank the Iowa State University Department of Agronomy and Agric. and Natural Resources Extension for partially funding this project, Pat Edmonds and Gretchen Rops for assistance with the field measurements.

References

- Archontoulis S, Miguez F, Moore K. (2014a). *Agronomy Journal*, 106: 1025–1040
- Archontoulis S, Miguez F, Moore K. (2014b). *Environmental Modelling and Software*, 62: 465–477
- Dietzel, R., M. Liebman, R. Ewing, et al., (2015). *Global Change Biology*, DOI 10.1111/gcb.13101
- Holzworth D., Huth N., deVoil P., et al., (2014). *Environmental Modeling and Software*, 62:327–350.

Modeling with stics the effects of no-tillage vs. tillage in cropping systems under contrasting pedoclimatic conditions

*Armas-Herrera*¹ – *Beaudoin*² – *Restovich*³ – *Andriulo*³ – *Affholder*⁴ – *Maltas*⁵ – *Olesen*⁶ – *Sharif*⁶ – *Laurent*⁷ – *Cohan*⁷ – *Mary*²

¹ EPSH, Universidad de Zaragoza, Ctra. Cuarte s/n, 22071 Huesca, cmarmas@unizar.es

² INRA, UR1158 AgrolImpact, 180 rue PG de Gennes 02000 Barenton-Bugny

³ Estación Experimental Agropecuaria Pergamino, INTA

⁴ CIRAD, UPR AIDA, Montpellier

⁵ Département Grandes cultures et systèmes pastoraux, Agroscope, Nyon

⁶ Department of Agroecology, Aarhus University, Tjele

⁷ Arvalis Institut du Végétal, Boigneville

Introduction

STICS has been widely employed in many agro-environmental contexts, especially in conventional tillage and temperate climate. But, few studies have evaluated STICS in no tillage and tropical conditions. Furthermore, these studies are based on ancient versions of the model, where the biological processes affecting the mulch of crop residues are not described. We hypothesized that i) the balances of water, C and N at a short, medium and long-term are more affected by the crop residues behavior than the soil structure when comparing the effects of no-tillage vs. tillage; ii) the residues behavior greatly depends on interactions occurring within the pedo-techno-climate conditions system. We tested here the ability of the new version of STICS (v8.3.1) to simulate cropping systems based on no-tillage and with a permanent cover of a mulch of plant residues under contrasting temperate and tropical climates.

Materials and Methods

Four mid-term field experiments were selected under temperate and tropical conditions, located in France (*Boigneville*), Denmark (*Foulum*), Argentina (*Pergamino*) and Brazil (*Rio Verde*) (Table 1). See Constantin et al., (2010), Hansen et al., (2010), Restovich et al., (2012), and Maltas et al., (2007) for more details of the sites. STICS was evaluated by comparing the model predictions with the observed values. We tested: i) aboveground biomass and N; ii) yield and N; water balance: soil water content (SWC) and water leaching; and iii) N balance: soil mineral N content (SMN), and NO₃ leaching. The comparison was made both in a reset mode and in a continuous simulation mode for the sites of *Boigneville*, *Foulum* and *Pergamino*, and only in a reset mode in *Rio Verde*. The performance of the model was evaluated calculating the mean difference (MD), the root mean square error (RMSE), and the model efficiency (EF).

Results and Discussion

We found some problems regarding the varieties selected for maize and soybean in *Pergamino* and *Rio Verde* sites, and for local varieties of winter wheat, spring oat, winter barley and spring pea in *Foulum*, which required the calibration of some plant parameters. In *Rio Verde*, it was also necessary to calibrate some general parameters of the model to adapt them to tropical conditions, such as a fast recycling of the labile N fraction in tropical soils, very high rainfall, and a strong nitrate retention (Sierra et al., 2003). After calibration, the results of simulation by using STICS v8.3.1 were good for most of the selected output variables in a continuous run ($0.4 < EF < 0.8$). The main exception was SWC in *Pergamino* and SMN in *Boigneville*, whose results were better in the reset mode than in the continuous run. Results in the *Rio Verde* site were also good ($0.5 < EF < 0.9$). It was possible to directly assess the ability of the new version for providing the mulch behavior of the crop residues only at *Rio Verde*, as opposed the other sites, where observed data are lacking. Yet, at the latter sites, the same set of parameters has provided realistic mulch behaviors.

Table 1. General characteristic of the study sites. CC= catch crops, NT= no-tillage, CT= conventional tillage, BS= bare fallow soil

	Climate	Duration	Crop rotation	Treatments
Boigneville (France)	Oceanic temperate (604 mm, 11.5°C)	1991-2006	w. wheat – s. barley – s. pea + CC	NT vs. CT + mulch + ≠ CC vs. BS
Foulum (Denmark)	Oceanic temperate (626 mm, 7.3 °C)	2002-2012	w. wheat – s. barley – pea – s. oats + CC	NT vs. CT + mulch vs. no mulch + CC
Pergamino (Argentina)	Temperate humid (971 mm, 16.5°C)	2005-2013	soybean-maize + CC	NT + mulch + ≠ CC vs. BS
Rio Verde (Brazil)	Humid tropical (1600 mm, 22°C)	2003-2005	soybean-maize + CC	NT + mulch + ≠ CC vs. BS

Conclusions

This *in silico* experiment leads us to revise the classification of parameters (local vs. global) while it permits to verify the reliability of our hypothesis. In a near future, STICS ability will be indirectly evaluated through the comparison between observed and simulated soil content of the water, carbon and nitrogen (mineral and organic).

Acknowledgements

This study was carried on within the IDE-STICS program, founded by the INRA/EandA division (France).

References

- Constantin, J., B. Mary, F. Laurent, et al (2010). *Agriculture, Ecosystems and Environment*, 135: 268–278.
 Hansen, E.M., L.J. Munkholm, B. Melander et al., (2010). *Soil and Tillage Research*, 109: 1–8.
 Maltas, A., M. Corbeels, E. Scopel et al., (2007). *Plant and Soil*, 298: 161–173.
 Restovich, S.B., A.E. Andriulo, S.I. Portela (2012). *Fields Crops Research*, 128: 62–70.
 Sierra, J., N. Brisson, D. Ripoche et al., (2003). *Plant and Soil*, 256: 333–345.

Do crop models based on daily incoming global light efficiently simulate crop growth under dynamic shade?

S. Artru¹ – L. Lassois² – S. Garre²

¹ Department of Biosystems Engineering (BIOSE), AgricultureLife platform, University of Liège, Gembloux Agro-Bio Tech, Passage des Déportés 2, 5030 Gembloux, Belgium, sidonie.artru@ulg.ac.be

² Department of Biosystems Engineering (BIOSE), University of Liège, Gembloux Agro-Bio Tech

Introduction

In agroforestry systems (AFS), the presence of tree canopy not only reduces the incident light for the crop, but also follows a dynamic spatio-temporal pattern. At the scale of a cropping season, the interrow species are subject to an intensification of shade following the tree phenology. At the daily time scale, the tree canopy induces a dynamic heterogeneous light environment according to the path of the sun, the plot design and tree management (Liu, 1991). This specific alteration of the quantity of light may induce physiological, morphological and yield changes for the species growing beneath the trees. At the moment, only a few studies deal with AFS in a temperate climate and especially studies on old AFS plantations are lacking. In this context models are powerful research tools that can help to generate insights into growth and productivity under evolving reduced light conditions. Most crop models simulating interspecific competition for global radiation (GR) use a shading algorithm in order to estimate the proportion of GR available for the intercropped species (Knörzer et al., 2011). This approach induces a reduction of the daily cumulated GR, but neglects the spatio-temporal variability which is characteristic for AFS. From the agronomic point of view, this raises the question whether the cumulative GR is enough to predict crop growth under heterogeneous light. In this study, we evaluate the ability of the model STICS to predict winter wheat (*T. aestivum* L.) development and yield under a reduced and variable light environment while using the daily cumulative value of GR as input variable.

Materials and Methods

Field experiment. In 2014, winter wheat (cultivar Edgard) was sown on the land of the experimental farm of Gembloux Agro-Bio Tech in Belgium (50.33°N, 4.42°N). An artificial shade structure with a precise orientation with respect to the sun and covered with military cloth was installed in order to test the effect of dynamic shade on the crop. Three distinct light conditions were obtained using this structure: (i) a continuous shade (CS) treatment inducing a reduction of light during the whole day; (ii) a periodic shade (PS) treatment producing intermittent shade on the plot along the day; and (iii) a no shade (NS) treatment under which 100% of the incident light is transmitted to the crop. Light at the crop canopy level was measured with quantum sensors (CS300 – Campbell Scientific Inc., USA). Data was recorded at a minute time interval and cumulated at the daily time step. The installation of the artificial shade structure and

the shade layers follow the phenology of a hybrid walnut tree. During the cropping seasons, biomass development, final yield were monitored in the field.

Modelling strategies. The STICS crop growth model (JavaSTICS v1.2) is fully described in the literature and validated for a broad range of crop species (Brisson et al., 2003; Brisson et al., 2009). It is a generic crop model simulating the soil–plant–atmosphere system dynamics on a daily time step. STICS was previously calibrated and validated for winter wheat under the same pedo-climatic environment for monocrop conditions (Dumont et al., 2012). In this study, we use the same parameter set to launch 3 simulations in which the only difference is the daily GR. The GR data recorded during the growing season in 2014 under the different light treatments (CS, PS, and NS) were used as climatic input variable. Using the field data, we will evaluate the capacity of STICS to simulate winter wheat aboveground biomass and LAI dynamics over the growing season and final yield and yield components (number and biomass of grains) under the 3 light regimes.

Results and Discussion

Preliminary results for the shade treatments show that a reduction in final grain yield and dry matter accumulation are predicted by STICS for the shade treatments, but with lower differences between treatments than the field observations. When shade is induced after the maximum leaf area stage, the LAI development of the crop does not differ between treatments using STICS, as also observed in the field. In the field experiment, both yield components (grain weight and grain number) were affected by shade. The simulations show an effect on grain weight but not on the grain number per m². In addition, the expected sensitivity of the crop to shade during the yield elaboration, ca. 30 days before flowering, is currently not reflected in the simulations.

Conclusions

In this first attempt to understand and predict the behavior of winter wheat under dynamic shade, we only modified the daily cumulative GR available to the crop. STICS reflects some of the observed changes in yield components, but the prediction is not yet satisfactory.

Acknowledgements

We thank the University of Liège, Gembloux Agro-Bio Tech and more specifically the research platform AgricultureLife for the funding of this research project.

References

- Brisson, N., C. Gary, E. Justes et al., (2003). *European Journal of Agronomy*, 18: 309–332.
- Brisson, N., M. Launay, B. Mary et al., (2009). In: *Collection Update Sciences and Technologies*, Ed.:Quae, 297.
- Dumont, B., V. Leemans, M. Mansouri et al., (2012). *Environmental Modelling and Software*, 52 : 121–135.
- Knörzer, H., H. Grözinger, S. Graeff-Hönninger et al., (2011). *Field Crops Research*, 121: 274–285.
- Liu, N. (1991). In: *Agroforestry Systems in China*, 14–20.

ECOFI: a generic agronomic database to facilitate analysis and crop modelling

*S. Auzoux*¹ – *L. Rouan*² – *R. Loison*¹ – *J.-F. Martiné*¹

¹ UR AïDA, CIRAD, Av. Agropolis, 34398 Montpellier, France, sandrine.auzoux@cirad.fr

² UMR AGAP, CIRAD, Av. Agropolis, 34398 Montpellier, France

Introduction

Studies of genotype x environment x management interactions and agroecology commonly use complex models such as Crop Simulation Models (CSM). Each model requires reliable minimum datasets (MD) for its successful implementation (Grassini et al., 2015; Nix, 1983). These MD are collected separately and can be multi-scale, multi-species, multi-disciplinary (agronomy, entomology, phytopathology, weed science, etc.) thereby making their use difficult in modelling. Furthermore, all variables are not measured simultaneously leading to the occurrence of many empty cells. All these problems can be solved using database technology (Hunt et al., 2001). This paper describes how the generic agronomic database ECOFI was implemented.

Materials and Methods

The database schema of ECOFI was built from the content of many CSM input files and field experiment datasets collected through studies in agronomy, entomology and phytopathology. We observed that although they are organized differently, most of the resulting agronomic databases shared the same measurements (yield, leaf area index, biomass, insect incidence, etc.) and a few similar tables corresponding to the minimum dataset (weather, soil, crop, and management data). Based on this analysis, we have designed the structure of ECOFI. It's divided into two parts: the first describes environmental conditions while the second describes all the possible cropping practices and agronomic measurements. It was implemented using the open source object-relational database management system PostgreSQL (©1996-2015 The PostgreSQL Global Development Group).

Results and Discussion

In standard databases, each additional observed variable implies to update the existing database schema or to create a new table. In ECOFI, we can add a new variable simply by adding a new record in one table (Figure 1). All variable labels are stored in a metadata table including the units of measurement, the type of variable observed and the scale of observation.

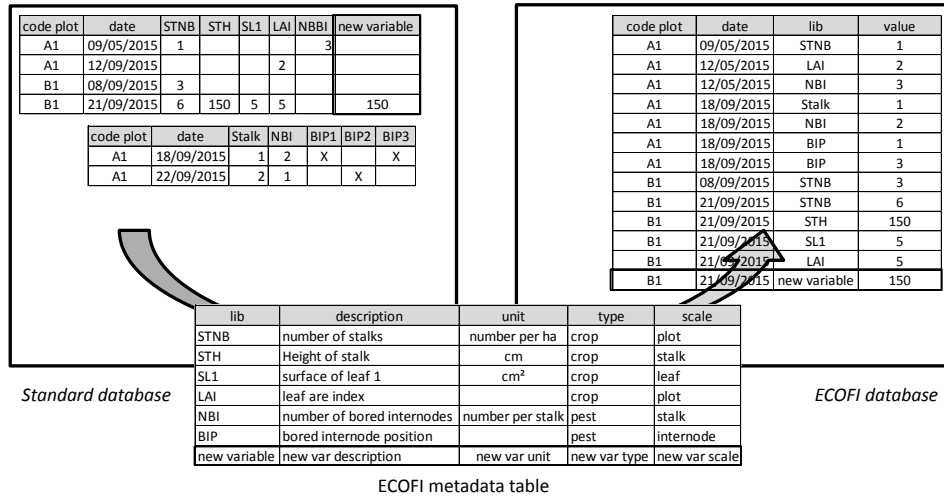

Figure 1. Standard database observation table versus ECOFI observation table using a metadata table

The technology of metadata is relevant as it allows the addition of as many data items as desired without changing the database schema. Another significant advantage is that it minimizes the number of tables, columns and empty cells. This makes it easier to export and manage the data. It also improves database query performance. ECOFI is available on a server and can also be used in disconnected mode when used with slow or no internet connection. ECOFI already has a wide application in pest management, plant disease and ecophysiological experiments on sugarcane, cotton and sorghum in Africa and Central America.

Conclusions

ECOFI is a performant optimized database that improves analysis and facilitates access to data for CSM. Genericness of database schema of ECOFI can allow intercomparison of CSM (AgMIP) that require the same datasets with no common data structure. It could also integrate other scales such as the gene or the landscape.

References

- Nix, H. A. (1983). In: Proceedings of the International Symposium on Minimum Data Sets for Agrotechnology, 181-188.
- Hunt, L.A., J.W. White, G. Hoogenboom (2001). Agricultural Systems, 70 (2-3): 477-492
- Grassini, P., LG.J. van Bussel, J. Van Wart et al., (2015). Field Crops Research, 177: 49-63.

Multifractal properties of spatially aggregated meteorological data – a regional study

P. Baranowski¹ – J. Krzyszczak¹ – H. Hoffmann² – C. Sławiński¹

¹*Institute of Agrophysics, Polish Academy of Sciences, ul. Doświadczalna 4, 20-290 Lublin, PL*

² Crop Science Group, INRES, University of Bonn, Katzenburgweg 5, 53115 Bonn, DE

* pbaranow@ipan.lublin.pl

Introduction

Large-scale crop simulations with process-based models rely on meteorological input data of coarse spatial resolution. Here we assess, how spatially aggregating meteorological data to coarser resolutions affects the data's temporal scaling properties. While it is known that spatial aggregation may affect spatial data properties, it is unknown how it affects temporal data properties. Moreover, changes in meteorological model input data may bias simulations. This aggregation effect (AE) may exceed 10 % in single year's regional crop yield when aggregating from 1 to 100 km resolution (Hoffmann et al., 2015). Since simulated crop yields depend on temporal and spatial input data properties, the AE must therefore be analysed with regard to both temporal and spatial input data properties. For this purpose, it is essential to analyse the temporal multifractal properties of the meteorological variables.

Materials and Methods

In order to assess the impact of spatial aggregation of meteorological time series on the temporal scaling properties, we analysed multifractal properties of meteorological time series. For this purpose, time series (1982–2011) were spatially averaged from 1 to 10, 25, 50 and 100 km resolution. Daily minimum, mean and maximum air temperature (2 m), precipitation, global radiation, wind speed and relative humidity (Zhao et al., 2015) were used. We used multifractal detrended fluctuation analysis (MFDFA) to reveal the multifractal structure of the time series, following Baranowski et al., (2015). The diversity of the studied multifractals was evaluated by the parameters of time series spectra. In order to analyse differences in multifractal properties to 1 km resolution grids, data of coarser resolutions was disaggregated to 1 km.

Results and Discussion

Effects of spatial averaging on multifractal properties were: i) Spatial patterns of the multifractal spectrum (MS) of all meteorological variables differed from 1 km grids (Fig.1). ii) MS-parameters were biased by -29.1 % (precipitation; width of MS) up to >4 % (min. Temperature, Radiation; asymmetry of MS). iii) The spatial variability of MS parameters was strongly affected at the highest aggregation (100 km, Fig. 2).

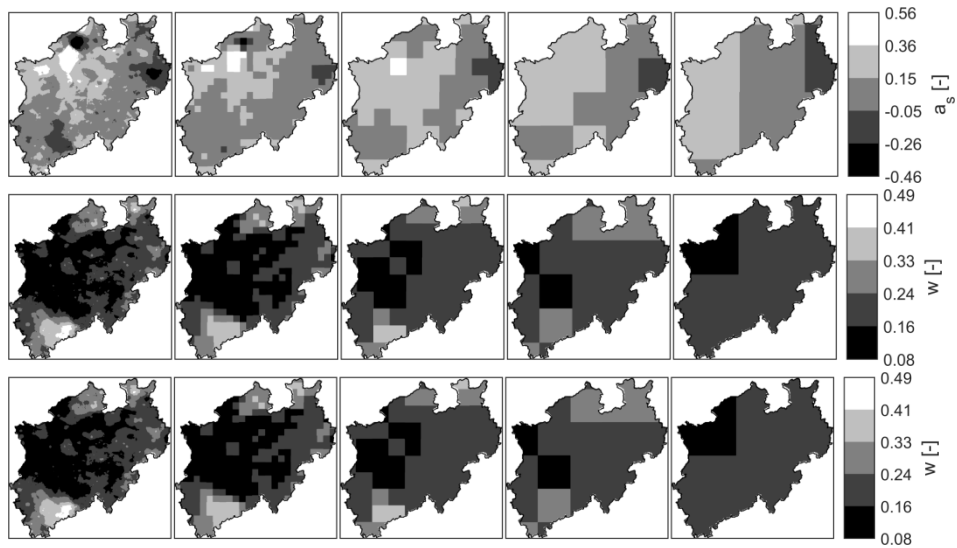

Figure 1. Multifractal properties asymmetry (a_s), α_0 and width (w) of precipitation time series spatially aggregated from 1 km to 10, 25, 50 and 100 km resolution (from left to right).

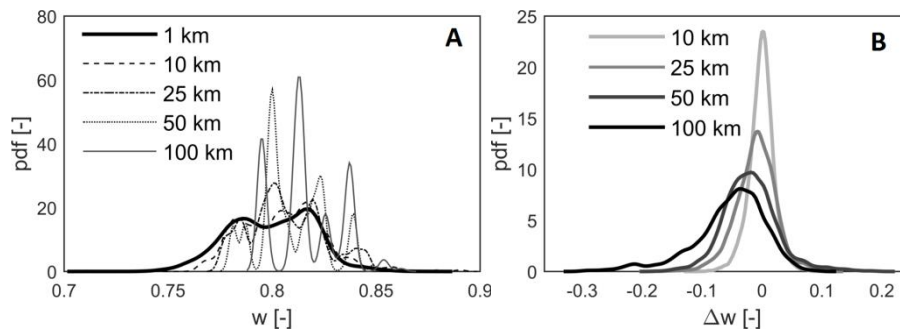

Figure 2. Probability density function of precipitation width (a_s) (A) and its differences across resolutions (B).

Conclusions

The results confirm that spatial data aggregation may strongly affect temporal scaling properties. This should be taken into account when upscaling for large-scale studies.

Acknowledgements

The study was conducted within FACCE MACSUR. Please see Baranowski et al., (2015) for details on funding.

References

- Baranowski, P., Krzyszczak, J., Sławiński, C. et al., (2015). *Climate Research* 65, 39-52.
 Hoffman, H., G. Zhao, L.G.J. Van Bussel et al., (2015). *Climate Research* 65, 53-69.
 Zhao, G., Siebert, S., Rezaei E. et al., (2015). *Agricultural and Forest Meteorology* 200, 156-171.

Comparison of five soybean crop growth models for yield estimation in southern Brazil

R. Battisti^{1,2} – *P. C. Sentelhas*¹

¹ Department of Biosystems Engineering, ESALQ, University of São Paulo, Piracicaba, SP, Brazil.

² E-mail: r.battisti@hotmail.com

Introduction

It is necessary to improve soybean yield looking for a sustainable agricultural (Sentelhas et al., 2015). In this context, crop models can help to improve the yield and production efficiency through evaluation of better management for the crop (Battisti and Sentelhas, 2014; Boote, 2011). Many crop models have been developed for soybean simulation, using dynamic processes. The uncertainties associated to these models have leading to the development of studies that compare their performance under different environmental conditions (Palosuo et al., 2011) and simulations based on multi-models ensembles has been preferred (Martre et al., 2015). Based on these aspects, the aim of this study was to calibrate and test five soybean crop models for the Southern Brazil and evaluate the ensemble of them for yield simulation.

Materials and Methods

The crop models used in this study were: FAO - Agroecological zone (Doorenbos and Kassam, 1979); AQUACROP (Raes et al., 2012); DSSAT-CROPGRO-Soybean (Boote et al., 2003); APSIM-Plant-Soybean (Keating et al., 2003); and MONICA (Nendel et al., 2011). The data used to calibrate these models were obtained from three experimental sites in 2013/2014 crop season in Southern Brazil, with different sowing dates and soil water availability (irrigated and rainfed) for the cultivar BRS 284, totaling 17 treatments (site x sowing date x irrigation). The calibration of the crop coefficients was for crop growth, development, and soils. The variables evaluated were yield, crop phases, harvest index, total above-ground biomass and leaf area index, which were analyzed using the root mean square error (RMSE) and index d of agreement. The results were analyzed considering the models individually as well as their ensemble.

Results and Discussion

The models were able to simulate soybean yield under different environmental and soil water conditions, resulting in a yield range between 1000 and 5000 kg ha⁻¹. The models had RMSE between 553 and 650 kg ha⁻¹, with good agreement between simulated and measured yields (d index higher than 0.90) (Table 1). The best result for yield was obtained by models ensemble, reducing RMSE to 262 kg ha⁻¹, showing a high agreement between measured and simulated yields (d = 0.98) (Figure 1).

Crop phases were estimated efficiently, although the models use different definitions, parameters and approaches. Total above-ground biomass had a RMSE lower than 2700 kg ha⁻¹ (44%) for the average of six points along the crop cycle. This error can be

considered high, but the models were able to simulate the curve of growth along crop cycle and showed close values at maturity. The same tendency was observed to leaf area index. The harvest index had the poorest performance, which was associated with model complexity, with AQUACROP values presenting a poor agreement ($d = 0.39$) with observed ones, whereas APSIM had the highest d index, of 0.65.

Table 1. Crop models performance for estimating soybean yield.

Models	Measured (kg ha ⁻¹)	Simulated (kg ha ⁻¹)	RMSE (kg ha ⁻¹)	d	Models	Simulated (kg ha ⁻¹)	RMSE (kg ha ⁻¹)	d
FAO		3006	650	0.91	APSIM	3038	550	0.90
AQUACROP	2883	3047	536	0.91	MONICA	2856	535	0.92
DSSAT		2948	548	0.93	Ensemble	2979	262	0.98

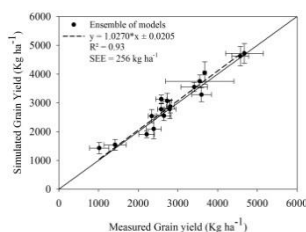

Figure 1. Relationship between measured and simulated soybean yield using the ensemble of five models. The bars indicate the standard errors.

Conclusions

All models were able to simulate soybean yield efficiently under different environmental and soil water conditions, with the best performance obtained when using the ensemble of these models.

Acknowledgements

The first author would like to thank the São Paulo Research Foundation (FAPESP) for the support to this study through the PhD scholarship (Process N° 2013/05306-0).

References

- Battisti, R., and P. C. Sentelhas (2014). *Revista Brasileira de Engenharia Agrícola e Ambiental*, 18: 1149-1156.
- Boote, K. J. (2011). In: Yadav, S.S., R. J. Redden, J. L. Hatfield et al., : *Crop adaptation to climate change*. West Sussex: Wiley-Blackwell, 17, 370-395
- Boote, K. J., J. W. Jones, W. D. Batchelor et al., (2003). *Agronomy Journal*, 95:32-51.
- Doorenbos, K. and A. M. Kassam (1979). *Irrigation and Drainage Paper n° 33*, 300 pp.
- Keating, B. A., P. S. Carberry, G. L. Hammer et al., (2003). *European Journal of Agronomy*, 18: 267-288.
- Martre, P., D. Wallach, S. Asseng et al., (2015) *Global Change Biology*, 21: 911-925.
- Nendel, C., M. Berg, K. C. Kersebaum et al., (2011). *Ecological Modelling*, 222: 1614-1625.
- Palouso, T., K. C. Kersebaum, C. Angulo et al., (2011). *European Journal of Agronomy*, 35: 10-114.
- Raes, D., P. Steduto, T. C. Hsiao et al., (2012). *Aquacrop - Reference Manual*.
- Sentelhas, P. C., R. Battisti, G. M. S. Câmara et al., (2015). *Journal of Agriculture Science, Online*, <http://dx.doi.org/10.1017/S0021859615000313>.

Identity-based analysis of GHG emissions from agriculture

E. H. Bennetzen¹ – P. Smith² – J. R. Porter³

¹ Department of Plant and Environmental Sciences, University of Copenhagen, Højbakkegaard Alle 30, DK-2630 Taastrup, Denmark, eskild@plen.ku.dk

² Institute of Biological and Environmental Sciences, University of Aberdeen, UK

³ Department of Plant and Environmental Sciences, University of Copenhagen, Denmark

Introduction

While global greenhouse gas (GHG) emissions continue to rise, emissions from agriculture and land-use change (LUC) are levelling out though production is still growing (Smith *et al.*, 2014). Yet we know little about changes in emissions per unit of food production – neither globally nor locally. While production needs to increase further, we must fast-track the process towards fewer emissions per produced unit. By applying a new identity framework (the KPI), we assess agricultural production and GHG emissions. The KPI is based on the well-known Kaya identity and is a new framework for combined assessment of GHG emissions *per unit area* and *per unit of product* and to assess how a change in each GHG emission category affects the change in total emissions – thus pointing to where things are going well and where things are going less well in relation to production (Porter and Christensen, 2013; Bennetzen *et al.*, 2015; Bennetzen *et al.*, 2012). We present global and regional changes in production and emissions from 1970 to 2007 and a global BAU trajectory for emissions.

Materials and Methods

For the world and nine world regions, we estimate agricultural production and associated GHG emissions from 1970 – 2007. Data on agricultural production and areas are from the FAO. From available activity data on crop- and livestock production and on direct- and indirect energy use we estimate GHG emissions using the IPCC 1996 Tier 1 equations (Houghton *et al.*, 1997). Emissions from LUC are from available data. Emission sources included are enteric fermentation (CH₄), manures (CH₄ and N₂O), synthetic N fertilizers (N₂O), rice cultivation (CH₄), direct and indirect energy use (CO₂), fodder production (CH₄, N₂O and CO₂) and LUC (CO₂). At global level, a future BAU range emission scenario is created by extrapolating from past changes in emission intensity for each emission source using expected production by 2030 and 2050 as projected by the FAO.

Results and Discussion

Agricultural production and GHGs have been steadily decoupled over recent decades. Emissions peaked in 1991 at ~12 Pg CO₂-eq. yr⁻¹ and have not exceeded this since. In 1970, the average carbon footprint *per unit crop* and *per unit livestock* was 65% and 78% higher than in 2007, respectively (Figure 1). Except for the energy-use component in farming, emissions from all sources have increased less than agricultural production.

However, There is a stark disconnect between regions where emissions occur and those where goods are produced; developed regions, in general, show less emissions per unit of production than developing countries.

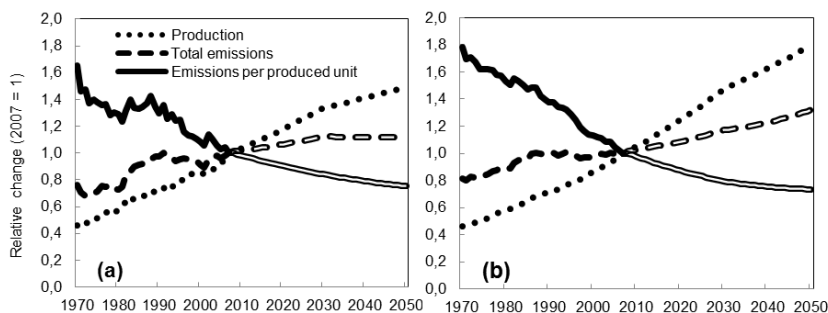

Figure 1. Relative changes in production, emissions and emission intensity from 1970 to 2007 for global crop production (a) and livestock production (b)

Our projected business-as-usual range suggests that global GHG emissions from agriculture and LUC may be further decoupled by 20 to 55% giving absolute agricultural emissions of 8.2 to 14.5 Pg yr⁻¹ by 2050.

Conclusions

Since global emissions *per unit of production* are in decline, it is higher production that drives the increase in absolute emissions. Growth in production mainly occurs in developing and transitional regions where the agricultural area is also expanding, whereas the agricultural area in developed regions is in decline. Absolute emission reduction can only occur when the rate of GHG efficiency improvements exceeds the rate of increase in demand.

References

- Bennetzen E.H., P. Smith, J.R. Porter (2015). Decoupling of Greenhouse Gas Emissions from Global Agricultural Production: 1970 – 2050. *Global Change Biology*, DOI: 10.1111/gcb.13120
- Bennetzen E.H., P. Smith, J-F. Soussana, J.R. Porter (2012). Identity-based estimation of greenhouse gas emissions from crop production: Case study from Denmark. *European Journal of Agronomy*, **41**, 66-72.
- Houghton J.T., L.G. Meira Filho, B. Lim *et al.*, (1997) *Greenhouse Gas Inventory: Workbook. Revised 1996 IPCC Guidelines for National Greenhouse Gas Inventories*. Intergovernmental Panel on Climate Change (IPCC), London, UK.
- Porter J.R. and S. Christensen (2013). Deconstructing crop processes and models via identities. *Plant, Cell and Environment*, **36**, 1919-1925.
- Smith P., M. Bustamante, H. Ahammad *et al.*, (2014). Agriculture, Forestry and Other Land Use (AFOLU). In: *Climate Change 2014: Mitigation of Climate Change. Contribution of Working Group III to the Fifth Assessment Report of the Intergovernmental Panel on Climate Change* (eds Edenhofer O., R. Pichs-Madruga, Y. Sokona *et al.*), pp. 811-922. Cambridge University Press, Cambridge, United Kingdom and New York, NY, USA.

Wheat post-anthesis nitrogen uptake, grain yield and protein content simulated with pyg model.

*A. G. Berger*¹ – *D. Vazquez*¹

¹ Rainfed Crops, INIA La Estanzuela, Ruta 50km 11 Colonia UY, aberger@inia.org.uy

Introduction

Wheat grain yield has increased constantly over time due to management and genetic improvement accompanied in some cases with high risk of reductions in grain protein content and baking quality. This reduction in grain protein content may result from the imbalance between carbon assimilation and, nitrogen assimilation and remobilization during grain growth (Pask et al., 2012). The balance between these components is determined by the conditions and length of vegetative growth that determines biomass and nitrogen accumulation, and the conditions during grain fill that determine grain protein content and grain biomass accumulation (Martre et al., 2003). These components are difficult to manipulate experimentally and modeling can contribute to better understand and quantify the relevance of each component.

Materials and Methods

The relationship among all the components of the carbon and nitrogen balance in the crop were analyzed and simulated with the model pyG. This model is a derivative of the model GECROS (Yin and vanLaar, 2005), which uses an hourly time step, simulates photosynthesis with a biochemical type model, and assumes an optimal allocation of nitrogen and carbon between crop components, among some of the main characteristics. The model was re-written in python, and several modifications relating nitrogen demand, grain number determination, and nitrogen balance were tested in this work. The results were contrasted with field data from experiments conducted during 2012, 2013, and 2014 with 11, 15 and 7 cultivars and three contrasting treatments, low nitrogen availability (lowN-lowN), high nitrogen availability (highN-highN), and low nitrogen availability until anthesis and high nitrogen availability thereafter (lowN-highN).

Results and Discussion

The experimental setup allowed us to observe all the range of low-high grain yield and low-high grain protein content. The model was able to capture the variability in yield and grain protein content as well as the dynamics of growth and nitrogen accumulation (Figure 1). It contributed also to determine the relevance of pre and post anthesis nitrogen uptake and the relevance of nitrogen remobilization in grain nitrogen balance and protein formation. Allowing the capacity to have deficiency driven soil nitrogen uptake in the post anthesis period significantly improved the fit to data. In the experiments, the proportion of nitrogen assimilated before anthesis was greater than after anthesis, however in the lowN-highN treatment and some cultivars of highN-

highN, the amount of nitrogen assimilated in post anthesis was significant. The capacity to assimilate nitrogen in post anthesis was significantly related to leaf senescence in the field and in simulations, and contributed (as indicated by simulations) to a larger capacity to assimilate carbon during grain fill.

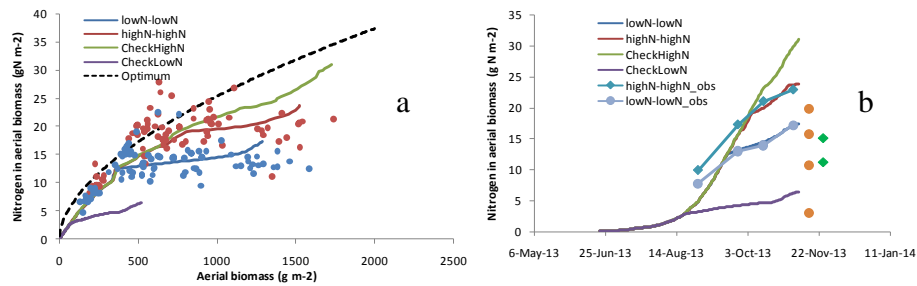

Figure 1. Accumulation of biomass and nitrogen for four contrasting simulated treatments and observed data (a). Evolution over the growing season of the same treatments and nitrogen in grain (b).

Conclusions

The model was able to simulate well yield and grain protein content, the plant nitrogen balance, and the trajectory of leaf senescence (driven by nitrogen demand) including the response of leaf senescence to post anthesis nitrogen availability.

Allowing post anthesis nitrogen uptake from the soil significantly improved the fit to observed data, in particular for lowN-HighN and highN-highN scenarios (high protein-low yield and high protein – high yield respectively).

Acknowledgements

Founding provided by INIA projects CS-13 and CS-09. We also thank the field support of M.X. Morales and R. Calistro.

References

- Martre, P., J.R. Porter, P.D. Jamieson et al., (2003). *Plant Physiology*, 133: 1959–1967.
 Pask, A.J.D., R. Sylvester-Bradley, P.D. Jamieson et al., (2012). *Field Crop Research* 126:104–118.
 Yin, X. and H.H. vanLaar (2005). Wageningen Academic Publishers, The Netherlands, 155pp.

A modelling approach for assessing environmental and economic impacts of agri-environmental schemes to enhance soil C sequestration and reduce pollution risks.

J. M. Blazy^{} – C. Barlagne – J. Sierra*

INRA, UR1321 ASTRO Agrosystèmes Tropicaux, F-97170 Petit-Bourg (Guadeloupe), France

* Corresponding author

Introduction

Because of the depletion of fossil energy resources, the increase in greenhouse gas (GHG) emissions and water contamination due to nitrate leaching, replacing inorganic fertilizers with organic amendments in agriculture could be a way to manage soil fertility in a more sustainable manner. In the French West Indies (FWI), a recent GHG inventory indicated that nitrogen (N) fertilizers ranked second after enteric fermentation among the most important causes of GHG emissions. This situation is particularly critical as climate change may lead to a decrease in soil organic matter content and an increase in CO₂ emissions (Sierra et al., 2010). Orienting farmers toward the use of organic amendments could reduce the negative environmental impacts of agriculture. Because of the low adoption rate of organic amendment, several Agri-Environmental Schemes (AESs) have been implemented to facilitate adoption by farmers (Barlagne, 2014). We propose a modelling approach for assessing the agri-environmental and economic impacts of AES schemes in yam cropping system.

Materials and Methods

We assessed the impacts of two AESs and compare them with the most widely-applied strategy based on inorganic N fertilizer (NFER), and with an organic strategy based on sewage sludge (SLUD), a free organic amendment. The first AES was proposed in 2007 (AESold) and only promoted the use of composts. The second was proposed in 2014 (AESnew) and combines the use of composts and inorganic N fertilizer at a rate 25% lower than NFER. Our approach involved three steps: (i) determination of the humification factor of the organic amendments, (ii) simulation with CropSyst-Yam of the performance of the soil-climate-yam system under the different scenarios and (iii) calculation of economic indicators using Ignamarge software (Causeret et al., 2012). CropSyst-Yam is a multi-year crop model that simulates crop development and growth of water yam, soil-crop-climate interactions, changes in soil water and C and N balances (Marcos et al., 2011). The model was calibrated and tested from experimental data and was run using weather records for the 2001-2010 period.

Results and Discussion

Crop yield presented a relatively high variability between years due to rainfall variation (Fig. 1). Crop yield was always higher under the NFER scenario but the differences between scenarios decreased over time. Nitrate leaching presented also a very high

variability among years. Nitrate leaching was always the highest under the NFER scenario and the lowest under AESold.

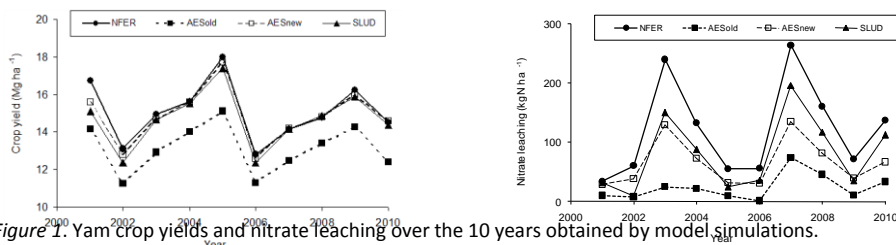

Figure 1. Yam crop yields and nitrate leaching over the 10 years obtained by model simulations.

Although AESold increased C sequestration by 300% (Fig. 2) and reduced nitrate leaching by 80% compared to NFER, it also reduced yields (13%) and net income for farmers (30%). The subsidy offered by AESold did not compensate the loss of productivity, which explains its low rate of adoption. AESnew and SLUD increased C sequestration (350% and 400%) and reduced nitrate leaching (45% and 34%), and it maintained yields and net income after five years of implementation. Yields and net income during the first five years were 5-10% lower than under NFER. Differences in C sequestration between the AES scenarios were small: C sequestration was only 0.2 Mg C ha⁻¹ higher under AESnew than under AESold.

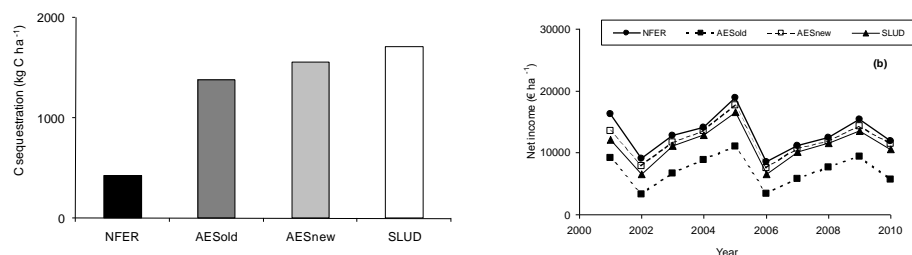

Figure 2. C sequestration at the end of the 10 years of simulation and evolution of net income for farmers.

Conclusions

AESnew could be a satisfactory policy instrument because it promotes environmental benefits and maintains economic income in the medium term. The economic performance of AESs was lower than NFER strategy during the first five years therefore the adoption rate could be improved by increasing subsidies during this period.

References

- Barlagne (2014). Integrated assessment of quality in the yam sector in Guadeloupe. PhD Thesis, University of the French West Indies, 283 p.
- Causeret, F., Barlagne, C., Bertrand, C., Blazy, J.M. (2012). Igmarge: a technical and economic evaluation tool of yam production. In: INRA (Ed.), Journ'iamas 2012, pp. 8-9.
- Marcos, J., Cornet, D., Bussière, F., Sierra, J. (2011). Water yam (*Dioscorea alata* L.) growth and yield as affected by the planting date: Experiment and modeling. *Eur. J. Agron.* 34, 247-256.
- Sierra, J., Brisson, N., Ripoche, D., Déqué, M. (2010). Modelling the impact of thermal adaptation of soil microorganisms and crop system on the dynamics of organic matter in a tropical soil under a climate change scenario. *Ecol. Model.* 221, 2850-2858.

Identifying trends and sources of uncertainty in potential rice productions under climate change in Mediterranean countries

*S. Bregaglio*¹ – *L. Hossard*² – *G. Cappelli*¹ – *F. Ruget*³ – *S. Delmotte*²

¹ Department of Agricultural and Environmental Sciences, University of Milan, via Celoria 2, 20133 Milan, Italy, simone.bregaglio@unimi.it

² Innovation and Development in Agriculture and Food, INRA, Montpellier, France

³ Modelling agricultural and hydrological systems in the Mediterranean environment, INRA, Avignon, France

Introduction

The overall impact of climate change on rice productions is expected to be uncertain in the world top producing countries (Tao and Zhang, 2013; Zhang et al., 2014), whereas it has not yet been evaluated in Europe, where it plays a pivotal sociocultural and ecological role (Longoni, 2012). European rice is grown in continuous flooding with high fertilizations in a Mediterranean climate, therefore main constraints are cold temperatures (Jena and Hardy, 2012) leading to damages from sowing (germination efficiency) to flowering, when temperature ranges increase the risk of pollen sterility. This paper presents the application of the rice model WARM (Confalonieri et al., 2009) to simulate potential yields in current and future climate conditions in two main European rice-producing areas, the Italian Lomellina and the French Camargue. The main objectives are the quantification of the main trends of future rice productions and the identification of the sources of uncertainty in climate change projections.

Materials and Methods

The WARM model was calibrated and evaluated against 20 field datasets with dynamic data of aboveground biomass and leaf area index, collected in the two case studies in the period 1987-2009. Rice varieties belonged to *Japonica* type. Synthetic 20-years weather series were generated starting from baseline data (1991-2010) according to the projections of four General Circulation Models (GCMs) and two representative CO₂ concentration pathways (RCPs; +2.6 W m⁻² and +8.5 W m⁻²). Two time horizons were considered, 2030 and 2070. Uncertainties in model estimates were assessed by analysis of variance using the GLM procedure (Olesen et al., 2007).

Results and Discussion

Figure 1 shows daily simulated dynamics of yields in Lomellina and Camargue according to various GCMs and RCPs. Model outputs highlight an increasing anticipating trend in the accumulation of grain biomass in 2030 and 2070, mainly due to the shortening of the crop cycle. A different impact of climate change in the two areas can be observed. Camargue rice productions will be quite stable in 2030 (+4.1% ÷ -13.8%) and will decline in 2070 (+2.6% ÷ -31.7%). Lomellina will experience higher yield reductions, with a steep decrease in 2030 (-10.1% ÷ -24.6%) and an even more

impact in 2070 (-8.8% ÷ -47.5%). The differences between the two study areas are mainly due to the magnitude of the projected temperature increase.

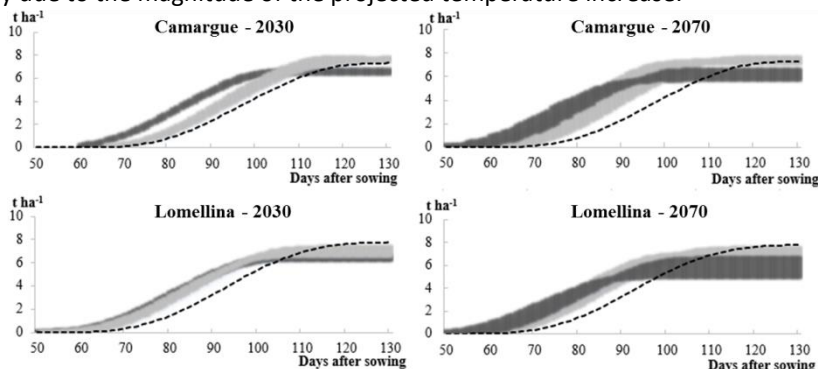

Figure 1. Daily average simulated values (20 years) of grain biomass in Camargue and Lomellina. Dark grey shades refer to GCM Hadley, light grey to MIROC in Camargue and GISS in Lomellina and indicate the min./max. value of the outputs of the two RCPs. Baseline data are indicated as dotted black line.

Table 1. Results of the GLM ANOVA carried out on 20-year series of final yields

Factor	d. f.	MS	P-value	Partial R ²	R ²	RMSE
GCM	3	30.92	<0.001	0.33	0.63	0.402
RCP	1	21.29	<0.001	0.08		
Site	1	49.10	<0.001	0.18		
Time horizon	1	13.02	<0.001	0.05		

Table 1 presents the results of the ANOVA performed on final simulated yield. When considering rice yields in both sites together for a 20-year series, all factors are highly significant. GCM is the top contributor to explain the variation of simulated yields.

Conclusions

The overall impact of climate change on European rice yields is expected to be negative in 2030 (-10%) and in 2070 (-15.8%) and variable across sites. The uncertainty in GCMs projections deeply impact on model outputs. Next step is the evaluation of adaptation strategies to reduce climate change impacts on rice productions.

Acknowledgements

This research is being conducted within the Scenarice project (n°1201-008) funded by the Agropolis and Cariplo foundations.

References

- Confalonieri, R., A.S. Rosenmund, B. Baruth (2009). *Agronomy for Sustainable Development*, 29: 463–474.
 Jena, K.K. and B. Hardy (2012). *International Rice Research Institute*, Los Banos, 105 pp.
 Longoni, V. (2012). *Waterbirds*, 35: 83–96.
 Olesen, J.E., R.T. Carter, C.H. Diaz-Ambrona et al., (2007). *Climatic Change*, 81: 123–143.
 Tao, F. and Z. Zhang (2013). *Journal of Applied Meteorology and Climatology*, 52: 531–551.
 Zhang, S., F. Tao and Z. Zhang (2014). *European Journal of Agronomy*, 54: 70–83.

“CHN”, a crop model to add value to phenotyping and approach genetic variation for RUE and WUE

*X. Le Bris*¹ – *B. Soenen*^{2*} – *M. Laberdesque*³ – *L. Maunas*³ – *D. Gouache*⁴ – *J. Lorgeou*⁵

¹ ARVALIS - Institut du végétal La Jaillière (44) – France

² ARVALIS - Institut du végétal Baziège (31) – France

³ ARVALIS - Institut du végétal Montardon (64) – France

⁴ ARVALIS - Institut du végétal Paris (75) – France

⁵ ARVALIS - Institut du végétal Boigneville (91) – France

* Corresponding author b.soenen@arvalisinstitutduvegetal.fr

Introduction

Increasing investments in high-throughput/high-resolution phenotyping will contribute to lifting the phenotyping bottleneck in plant breeding (Araus and Cairns, 2014) : this is addressed by the Phenome project in France. Models are important tools to interpret the complex relations between traits, environmental variation, and breeding targets such as yield (Hammer et al., 2006)

Materials and Methods

“CHN” is a mechanistic crop model of the soil-plant-atmosphere continuum. It estimates daily flows of carbon (C), water (H) and nitrogen (N) between the different compartments of the system. The soil compartment is connected to a database, which regroups the different soils in French regions, and uses pedotransfer functions for estimating useful characteristics of soil. Stocks of water, carbon (stable and labile pools) and nitrogen (urea, ammonia, nitrate and organic pools) are daily modeled in 1 cm depth layers. The atmosphere compartment is connected to a database, with multiannual weather data throughout France. The plant compartment is based on the Monteith approach (Monteith, 1997): leaf area is modeled and depends on simulated development stages. Leaf area intercepts radiation, which is converted into biomass. Roots growth is modeled and determines nitrogen and water available for the plant. Growth is affected by nitrogen and water deficiency, using the stress response functions developed by Sinclair (Sinclair, 1986).

A French maize database, based on 65 maize trials (1988-2014) and 431 experimental treatments (site-year by management), allowed to parameterize “CHN” plant parameters on maize.

The aim of this study is to estimate genetic traits on maize, which are parameters of “CHN” model, like Radiation Use Efficiency (RUE) or Water Use Efficiency (WUE). Indeed a part of the deviation of the model with generic parameters could be explained by genetic variability.

Results and Discussion

This crop model can be used to manage nitrogen and water, or even to characterize growth conditions of phenotyping trials in order to improve the understanding of genotype – environment interactions.

Moreover it is possible to link the deviation to the generic model with genetic variability. Indeed in addition to high performance phenotyping platforms, it is possible to estimate genetic traits on maize, which are parameters of “CHN” model, like Radiation Use Efficiency (RUE) or Water Use Efficiency (WUE).

Conclusions

PhénoField®, a high throughput phenotyping platform, will provide access to dynamic LAI measurements for 100s of genotypes in varied controlled drought conditions. Such model genetic parameters could be linked to molecular markers (Technow et al., 2015).

References

- Araus, JL, and Cairns JE. (2014). Field high-throughput phenotyping: the new crop breeding frontier. *Trends in plant science* 19.1: 52-61
- Hammer G. et al., (2006). Models for navigating biological complexity in breeding improved crop plants. *Trends in plant science* 11.12: 587-593.
- Monteith JL. (1977). Climate and the efficiency of crop production in Britain. *Philosophical. Transactions. The Royal Society publishing. Lond.* 281:277-294.
- Sinclair TR. (1986). Water and nitrogen limitations in soybean grain production. I. Model development. *Field Crops Research.* 15:125-141
- Technow F., Messina CD., Totir L.R., Cooper M. (2015). Integrating crop growth models with whole genome prediction through approximate Bayesian computation. *PloS One*, DOI: 10.1371/journal.pone.0130855.

Multicriteria evaluation of the stics soil-crop model and implementation of an automated evaluation system

*S. Buis*¹ – *E. Coucheney*^{2,7} – *M. Launay*³ – *P. Lecharpentier*¹ – *B. Mary*² – *D. Ripoche*³ – *N. Beaudoin*² – *F. Ruget*¹ – *I. G. de Cortazar-Atauri*³ – *E. Justes*⁴ – *J. Constantin*⁴ – *K. S. Andrianarisoa*^{2,5} – *C. le Bas*⁶ – *J. Léonard*²

¹ INRA, UMR 1114 EMMAH, INRA – UAPV, 84914 Avignon, France, Samuel.Buis@avignon.inra.fr,

² INRA, UPR 1158 AgrolImpact, Site de Laon, 02000 Barenton-Bugny, France

³ INRA, US 1116 AgroClim, 84914 Avignon, France

⁴ INRA, UMR 1248 AGIR, INRA-INP-ENSAT, 31326 Castanet-Tolosan, France

⁵ BioGAP, ISA de Lille, F-59046 Lille cedex, France

⁶ INRA, US 1106 InfoSol, 45075 Orleans, France

⁷ Department of Soil and Environment, Swedish University of Agricultural Sciences, 75007 Uppsala, Sweden

Introduction

The STICS soil-crop model version 8.2.2 with its standard set of parameters has been evaluated with multiple complementary methods over a large dataset covering 15 crops and a wide range of agropedoclimatic conditions in France (Coucheney et al., 2015). An automatic evaluation system has been built following this work for a continuous monitoring of the model performances in parallel with its development.

Materials and Methods

STICS is a soil-crop model which has been developed at INRA since 1996 (Brisson et al., 2009) and which software and documentation are freely available on the web at http://www6.paca.inra.fr/stics_eng. It was conceived as a generic model able to adapt to various kind of crops and environmental conditions.

The dataset contains a total of 1809 simulation units covering 76 sites during the 1978-2009 period (440 site.years) and the main French crops (cereals, oilseeds and legume species, catch crops, forages, perennial crops), climatic areas, soils and agronomic practices. Situations which had been used in past studies to calibrate the value of one or several plant parameters provided with the standard version of the model were identified (one third of the total number).

Evaluation method combined accuracy, robustness and behavioral analyses. Model accuracy was evaluated by computing multiple complementary statistical criteria (RMSEs, RMSEu, EF, R², ...). To evaluate the model robustness we proposed to analyze the sensitivity of residuals to the crop type and to selected agro-pedoclimatic indicators with variance analysis technics.

Results and Discussion

Model results showed a good overall accuracy, with little bias. Relative RMSE was larger for soil nitrate (49%) than for plant biomass (35%) and plant nitrogen content (33%) and smallest for soil water (10%). Performances for most variables lay in the very good to satisfactory range according to the boundaries defined by Moriasi et al.,

(2007) (Fig. 1). Observed trends induced by contrasted environmental conditions and management practices (N fertilization and irrigation mainly) were shown to be well reproduced by the model and robustness analysis showed limited dependency of model errors to crop type and environment.

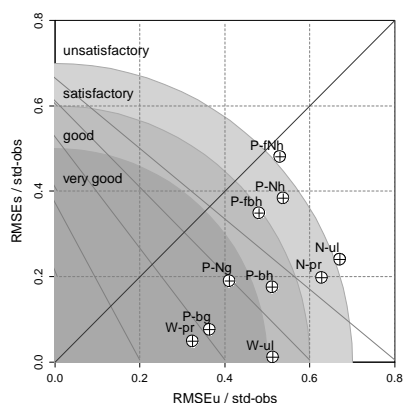

Figure 1. Graphical decomposition of model RMSE between unsystematic (u) and systematic (s) contributions, for several outputs: plant variables at harvest (P-bh: aerial biomass in t ha⁻¹, P-Nh: N in the plant in kg ha⁻¹, P-fbh: fruit biomass in t ha⁻¹ and P-fNh: N content in fruits in % odb), plant variables along the growing season (P-bg: aerial biomass in t ha⁻¹, P-Ng: N in the plant in kg ha⁻¹), soil water and nitrate variables in the upper layer and in the soil profile respectively (W-l1: water content in g g⁻¹, W-pr: water amount in mm, N-l1 and N-pr: nitrate amount in kg ha⁻¹).

Following this work, a continuous integration system was built using Jenkins (<http://jenkins-ci.org/>) to link SVN-based version control system of the model sources and parameters, the evaluation dataset and R functions of test and performance evaluation. Each time the STICS source code or parameter values are modified in the SVN repository, test and evaluation procedures are now automatically performed.

Conclusions

Measured accuracies were similar to what was found in literature for other crop models evaluated on smaller datasets and generally with calibration steps. The combination of good level of accuracy and robustness makes STICS a valuable tool for studying the effects of changes in agro-ecosystems over the domain explored. The automatic evaluation system will allow preserving and enhancing performances and robustness of future versions of the model and associated parameters.

References

- Brisson, Nadine, Launay, M., Mary, B., Beaudoin, N., and et al., (2009). Conceptual Basis, Formalisations and Parameterization of the Stics Crop Model. éditions Quae.
- Coucheny, E., Buis, S., Launay, M., Constantin, J., Mary, B., Garcia de Cortázar-Atauri, I., ... and Léonard, J. (2015). Accuracy, robustness and behavior of the STICS soil-crop model for plant, water and nitrogen outputs: evaluation over a wide range of agro-environmental conditions in France. EMS, 64, 177-190.
- Moriasi, D., Arnold, J., Van Liew, et al., (2007). Model evaluation guidelines for systematic quantification of accuracy in watershed simulations. Transactions of the ASABE, 50(3), 885-900.

Variation in rain-fed rice yields in INDIA under a changing climate

*P. B ker*¹ – *C. J. McClean*² – *K. Singh*³ – *P. Swain*⁴ – *S. E. Hartley*⁵ – *J. K. Hill*³

¹ Stockholm Environment Institute-York, Environment Department, University of York, York, YO10 5DD, U.K.

² Environment Department, University of York, York, YO10 5DD, U.K.

³ Biology Department, University of York, York, YO10 5DD, U.K.

⁴ Crop Physiology and Biochemistry Division, Central Rice Research Institute, Cuttack, 753006, Odisha, India

⁵ York Environmental Sustainability Institute, University of York, York, YO10 5DD, UK

Introduction

Predicted changes in the South Asian summer monsoon, characterised by increased variation in monsoon onset and intensity, could lead to lower yields for India's rain-fed rice farmers (Auffhammer et al., 2012). Process-based crop growth models such as DSSAT (Jones et al., 2003) are capable of modelling future yields under climate change scenarios (Wallach et al., 2006), thereby functioning as a key tool for food security assessments. Here, we assessed DSSAT's ability to predict spatial and temporal variation in district-level rain-fed rice yields in India.

Materials and Methods

We ran DSSAT (Jones et al., 2003) for the Swarna rice variety using gridded (0.5 x 0.5°) daily GRASP weather data (Iizumi et al., 2014) covering India's entire rain-fed rice areas for the monsoon growing season (June to October) over a 13-year period (1998-2010) and assessed how well model outputs predicted observed district-level rain-fed rice yields as provided by the Ministry of Agriculture, Government of India (<http://drd.dacnet.nic.in>; district-level data (average district size: ~ 5700 km²), for no specific rice variety). We varied management parameters such as plant density, row spacing and fertilizer inputs within realistic boundaries as well as sowing and transplanting dates in accordance with recently reported fluctuations of these dates from the region.

Results and Discussion

DSSAT predicted the yield of rain-fed rice for 13 consecutive years to be within 10% of the observed yield for 60% of all grid cells. As an example, Fig. 1 and 2 show for the year 2006 that approx. 70% of the observed variation in rice yield is explained by DSSAT predictions. The best average fit was achieved for the states Chhattisgarh, Odisha, Jharkhand and Bihar; the high discrepancies between observed and modelled yields for some parts of Maharashtra, Madhya Pradesh and Assam are caused by DSSAT's tendency to over- and underpredict rice yields in relatively drier and warmer (West India) and wetter and cooler (East India) areas, respectively. Also, the used range of management parameters might not have represented farming characteristics of these climatically more extreme areas.

Our results show that for many rain-fed rice areas across India, DSSAT can model observed yields, allowing us to use these models to examine changes in future rice

yields, using DSSAT's perturb tool (CLIMsystems Ltd.), which provides weather data based on IPCC Representative Concentration Pathways for 2030, 2050 and 2100.

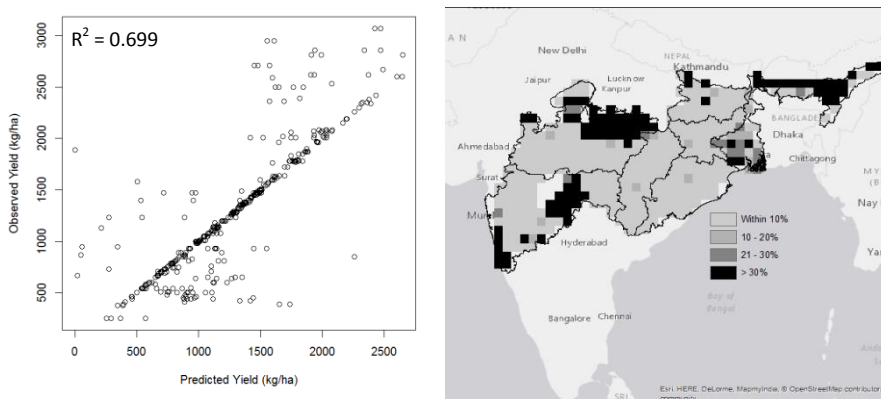

Figure 1 (left). Predicted vs. observed yield in 2006 for Indian rain-fed rice areas plotted in Fig. 2 (0.5 x 0.5°);

Figure 2 (right). Spatial variation in predicted vs. observed yield (in 2006), showing that models were within 10% agreement of observed yields over >60% of all Indian rainfed-rice growing areas.

Conclusions

DSSAT has been predominantly used for yield predictions at field-level, but we have shown that it can be applied successfully to model current rain-fed rice yields over much larger spatial and temporal scales. This opens up opportunities to use DSSAT to project future yields, and to examine the implications of planting new drought-tolerant rain-fed rice varieties over much larger areas than was previously possible.

Acknowledgements

This work was funded by the Biotechnology and Biological Sciences Research Council, the Department for International Development and (through a grant to BBSRC), the Bill and Melinda Gates Foundation, under the Sustainable Crop Production Research for International Development (SCPRIID) programme, a joint initiative with the Department of Biotechnology of the Government of India's Ministry of Science and Technology.

References

- Auffhammer, M., V. Ramanathan and J.R. Vincent (2012). Climate change, the monsoon, and rice yield in India. *Climatic Change*, 111: 411–424.
- Iizumi, T., M. Okada and M. Yokozawa (2013). A meteorological forcing data set for global crop modeling: Development, evaluation, and intercomparison. *Journal of Geophysical Research: Atmospheres*, 119: 363-384.
- Jones, J.W., G. Hoogenboom, C.H. Porter et al., (2003). DSSAT Cropping System Model. *European Journal of Agronomy*, 18: 235-265.
- Wallach, D., D. Makowski and J. Jones (Eds.) (2006). *Working with Dynamic Crop Models - Evaluation, Analysis, Parameterization, and Applications*. Elsevier, Amsterdam, The Netherlands, 462 pp.

Uncertainties of different weather data input on three multi-models simulations of yield and water use

D. Cammarano^{1*} – *M. Rivington*¹ – *K. B. Matthew*¹ – *D. G. Miller*¹ – *G. Bellocchi*²

¹ The James Hutton Institute, Craigiebuckler and Invergowrie, Aberdeen and Dundee, AB15 8QH and DD2 5DA, UK;

² Grassland Ecosystem Research Unit, French National Institute of Agricultural Research, 5 Chemin de Beaulieu, 63039 Clermont-Ferrand, France.

* Corresponding author: Davide Cammarano, Email: davide.cammarano@hutton.ac.uk

Introduction

One of the sources of uncertainty in simulating the plausible impacts of climate change on crop production is the usefulness of the weather projections. Climate model outputs provide both biased and uncertain representations of observed data, and therefore there will be errors related with the use of the projections. Building on previous research about the link between weather data type, sources with known biases, and multiple crop model errors, we investigated the complexities in using climate model projections representing different spatial scales within climate change impacts and adaptation studies.

Materials and Methods

Five weather data sets were used in this study: i) observed weather data (1960-1990) from The British Atmospheric Data Centre (BADC, 2006); ii) the HadRM3 initial realisation original hindcast (OrH); iii) the OrH downscaled using the bias correction (BC) method of Rivington et al., (2008) (DsH); the HadRM3 estimates for the SRES A2 (medium-high GHG emissions) original future projections for 2070-2100 (OrF); iv) the OrF data downscaled using the BC method (DsF). The three crop simulation models used for this study were the APSIM, CropSyst, and DSSAT models to represent a generic spring barley crop at 12 UK sites. A single reference sandy loam soil was used for the simulations across the 12 sites. A spring barley cultivar was calibrated using data from barley variety trials.

Results and Discussion

The results of running three spring barley simulation models using observed weather data and original and downscaled RCM data, has shown that attention is required in interpreting model outputs because misleading conclusions could be drawn from results where original climate model projection estimates are used in modelling studies of future impacts. The OrH rainfall had a very different impact on crop model daily patterns of evapotranspiration and water stress index. Using the results of a single crop model would also be a limiting factor in studying projected climate impacts on agricultural production.

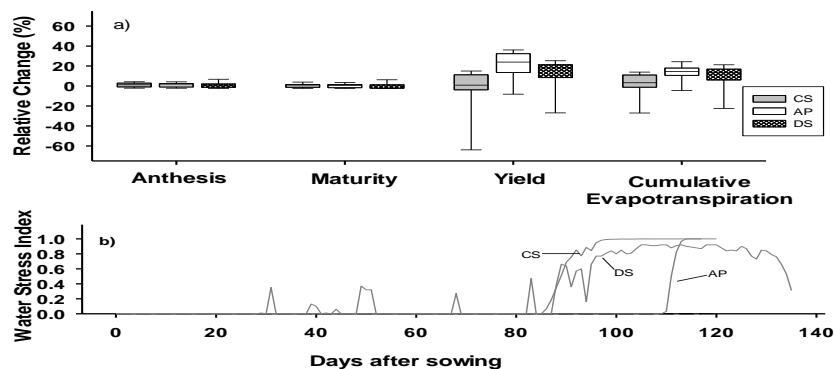

Figure 1. (a) Relative change between BADC and OrH respect for CropSyst (CS), Apsim (AP), and DSSAT (DS) and (b) daily water stress index for one weather station using the OrH as input to the models.

The three crop models used were very close in simulating phenology, with variability existing in simulating yield and evapotranspiration. Although these three models are not like climate models, and when initial conditions and other inputs are given correctly they should be able to simulate similar yields and growth rates. However, the interacting effects of the way their processes are modelled and the way similar equations describing growth are parameterized will cause variability between models.

Conclusions

Based on the results of this study, we argue that the types of errors manifesting themselves due to weather data source in crop model estimates will also occur in other types of environmental models (ecological, hydrological, etc.). The lessons learned from the behaviour of the crop models can be informative to these other types of models. Though not tested here, it would seem logical that other types of downscaling (i.e. statistical or weather generators) and other bias correction methods, would also have a similar form of impact.

Acknowledgements

The results of this research were obtained within an international research project named “FACCE MACSUR – Modelling European Agriculture with Climate Change for Food Security, a FACCE JPI knowledge hub”. The authors would like to thank the Scottish Government’s Rural and Environment Science and Analytical Services Division (RESAS) and the meta-programme Adaptation of Agriculture and Forests to Climate Change (AAFCC) of the French National Institute for Agricultural Research (INRA) for their funding support of this research. Thanks to Mr. K. Marsh at the BADC for processing the HadRM3 model data and to the Meteorological Office and Hadley Centre for permission to use their data.

References

- BADC (2006). British Atmospheric Data Centre. <http://badc.nerc.ac.uk/home/index.html>
 Rivington, M., Miller, D., Matthews, et al., (2008). Downscaling Regional Climate Model estimates of daily precipitation, temperature and solar radiation data. *Climate Research*, 35: 181-202.

A model based approach to assist variety assessment in sunflower crop

P. Casadebaig¹ – P. Dedaeke¹ – E. Mestries²

¹ INRA, UMR AGIR, CS 52627, 31326 Castanet-Tolosan, France, e-mail: debaeke@toulouse.inra.fr

² Terres Inovia, c/o UMR AGIR, CS 52627, 31326 Castanet-Tolosan, France

Introduction

Variety assessment is a key component of crop performance improvement (e.g. potential yield, quality, disease resistance, abiotic stress tolerance, resource-use efficiency, environmental benefits). More knowledge-based technology (from sensors to process-based crop models) must be developed for and applied to the variety assessment sector (breeders, advisors) to enhance the efficiency of variety testing process which is presently exclusively based on experimental field approaches. Crop models with explicit varietal parameters must be developed or adapted for characterising the environments and designing varietal ideotypes under future climates and crop management scenarios (Jeuffroy et al., 2014 ; Rötter et al., 2015).

In sunflower, we developed a 4-steps model-based approach to assist variety assessment in due time and to amplify the environmental and agronomic conditions in which the new varieties are routinely tested (Figure 1): (1) variety phenotyping and model parameterization; (2) model validation on multi-environment trials (MET); (3) 'numerical experimentation' to complement actual MET; (4) identification of variety - environment - management combinations maximizing crop performance.

Materials and Methods

The SUNFLO crop model (Casadebaig et al., 2011; Lecoœur et al., 2011) was parameterized for 35 recent oleic and linoleic sunflower cultivars. The values of the genotype-dependent parameters were obtained by measuring 10 phenotypic traits in dedicated field platforms (2 locations per year) or controlled conditions (Casadebaig et al., 2008; Debaeke et al., 2010). The following results focus on 2009 season, a relatively dry year where the model was evaluated in 53 experimental locations (variety trials) in France. As a proof of concept, a numerical design of experiments was defined (n=73500: 35 varieties x 5 locations x 35 years x 2 soil depths x 2 sowing dates x 3 plant densities) and simulated to determine the best varieties and related management in selected French production regions. Grain yield, oil concentration and oil yield (OY) were simulated with SUNFLO as a function of climate, soil, management and genotype-dependent parameters.

Results and Discussion

After the model parameterization for the newly released hybrids (step 1), we independently evaluated SUNFLO prediction capacity on the 2009 MET (relative RMSE

for oil yield: 15.8%) and its capacity to rank those commercial hybrids (Kendall's tau = 0.39, $p < 0.01$) according to OY (step 2).

We tested the model capacity to simulate GxE interactions in the numerical experiment (step 3) by comparing two nested linear mixed models differing by the interaction term (LRT: $\chi^2(482)=3561$, $p < 0.001$, interaction model was a better fit).

We proceeded to optimize the variety-environment-management choice: advising different varieties according to cultivation areas was a better strategy than relying on the global adaptation of varieties (step 4).

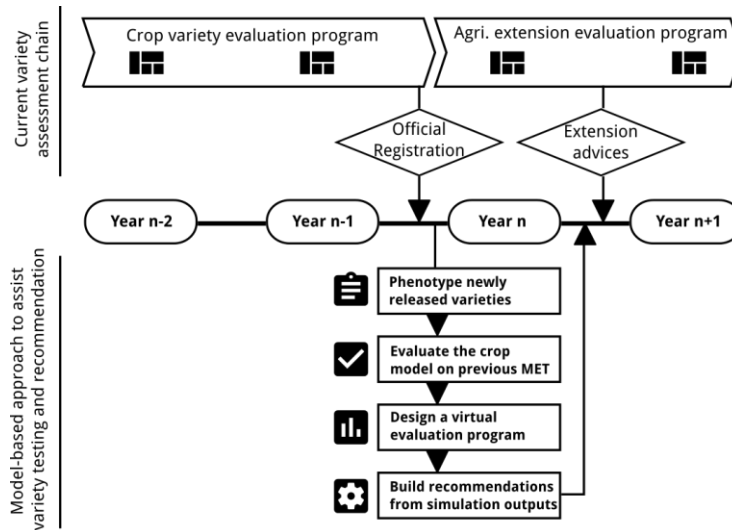

Figure 1. Proposed framework to assist current variety assessment and recommendation with crop modeling and simulation.

Conclusions

We suggest that crop modeling and simulation could successfully complement the current variety assessment chain in France and leverage the opportunities to exploit G by E interactions for better adapting variety choice locally.

Acknowledgements

This study was supported by the French Ministry of Agriculture (AAP CTPS 2007 and 2010) and by Promosol association.

References

- Casadebaig P., Debaeke P., Lecoer J. (2008). *European Journal of Agronomy* 28, 646-654.
- Casadebaig P., Guillion L., Lecoer J. et al., (2011) *Agricultural and Forest Meteorology* 151, 163-178.
- Debaeke P., Casadebaig P., Haquin B. et al., (2010). *OCL* 17, 143-151
- Jeuffroy M.H, Casadebaig P., Debaeke P. et al., (2014). *Agronomy for Sustainable Development* 34, 121-137
- Lecoer J., Poire-Lassus R., Christophe A., et al., (2011). *Functional Plant Biology* 38, 246-259.
- Rötter R.P., Tao F., Höhn J.G et al., (2015). *Journal of Experimental Botany*, doi:10.1093/jxb/erv098

When and what meteorological stresses will MAIZE and winter wheat crops meet in the future in France?

J. Caubel^{1,2}– A.-C. Vivant¹– I. G. de Cortazar Atauri²– N. de Noblet-Ducoudré¹– M. Launay²– F. Huard²

¹ Laboratoire des Sciences du Climat et de l'Environnement, Unité Mixte CEA-CNRS-UVSQ, Orme des Merisiers, 91191 Gif-sur-Yvette cedex, France; julie.caubel@avignon.inra.fr

² AGROCLIM, Unité de Service 1116, INRA centre de recherche PACA, 228 route de l'Aérodrome, CS 40 509, Domaine Saint Paul, Site Agroparc, 84914 Avignon cedex 9, France.

Abstract

In the context of climate change, we could expect changes in overall climatic conditions and therefore, on the suitability for cropping. Assessment of when and what meteorological stresses will crops meet in the future is highly useful for planners, land managers, farmers and plant breeders who can propose and apply adaptation strategies to improve agricultural potentialities.

In this study, we will present our evaluation of the impacts various climatic scenarios may have on suitability for maize and winter wheat cropping in terms of ecophysiology (e.g., heat stress during grain filling), yield quality (e.g., effects of thermal conditions on protein content) and cultural practices performance (e.g., days available for harvest according to risk of waterlogged soil compaction by machinery) in two French areas (see Figure). The Midi-Pyrénées (southern) and Ile-de-France (northern) regions were chosen as representing in a simplified way of two distinct French climates when dividing France into southern and northern parts. The Midi-Pyrénées region is a major irrigated maize producer but could become more and more penalizing for e.g. maize in a context of climate change because of heat and water stress. By contrast, northern France could become a more suitable area for this crop thanks to the expected increasing temperature. Regarding winter wheat we expect increasing thermal stress in the south of France at the end of the growing cycle, as well as increased water stress for pluvial crops.

We have used the assessment's method for crop-climate suitability developed in Caubel et al., (2015) and based on the sub-annual analysis of agroclimatic indicators calculated over phenological periods. These indicators are highly relevant since they provide accurate information about meteorological stresses on particular plant processes and cultural practices that take place during specific phenological periods. Our indicators have been calculated using the historical reanalysis SAFRAN which covers France at 8 km resolution for the 1959-2011 time period (Vidal et al., 2009). Future changes have been calculated using downscaled climate changes from the fourth IPCC climate simulations. Several combinations of SRES (A1B, A2 and B2) socio-

economic scenarios and regional climate changes downscaled from global climate models were analyzed¹.

Two distinct varieties have been looked at, in terms of precocity, in order to evaluate the impact of climate change on both short and long-cycle varieties. The crop phenological stages were obtained from a growing degree day model adapted for each crop type (Derieux and Bonhomme, 1990 and Brisson et al., 2008 for maize and wheat respectively). The evaluation was performed both with a unique sowing date corresponding to the current one, and with a moving sowing date to mimic a potential adaptation of farmers' behavior to climate change. Consequences on phenology and therefore meteorological stresses enable to decide where and when adapting the sowing date will be useful for improving maize and winter wheat potentialities.

This work is carried out under the research program ORACLE (Opportunities and Risks of Agrosystems and forests in response to CLimate, socio-economic and policy changEs in France; <https://oracle.lsce.ipsl.fr/>).



Figure: Red areas are those where our specific indicators have been calculated

References

- Brisson, N., Launay, M., Mary, B., Beaudoin, N. (2008). Conceptual basis, formalisations and parameterization of the STICS crop model, Conceptual basis, formalisations and parameterization of the STICS crop model (Ed. Quae), 297 pp. Alington, A., B. Bewater, C. Cecil et al., (2012). *Acta Agronomica Berlingia*, 55: 47–61.
- Caubel, J., Garcia de Cortazar-Atauri, I., Launay, M., de Noblet-Ducoudr, N., Huard, F., Bertuzzi, P., Graux, A.-I. (2015) : 'Broadening the scope for ecoclimatic indicators to assess crop climate suitability according to ecophysiological, technical or quality criteria'. *Agricultural and Forest Meteorology*, 207, 94-106.
- Derieux, M., Bonhomme, R. (1990). Heat units requirements of maize inbred lines for pollen shedding and silking – results of the European FAO network. *Maydica* 35 (1), 41–46.
- Pagé, C., L. Terray and J. Boé (2009): dsclim: A software package to downscale climate scenarios at regional scale using a weather-typing based statistical methodology. Technical Report TR/CMGC/09/21, SUC au CERFACS, URA CERFACS/CNRS No1875, Toulouse, France.
- Vidal J.-P., Martin E., Franchistéguy L., Habets F., Soubeyroux J.-M., Blanchard M., Baillon M. (2009). Multilevel and multiscale drought reanalysis over France with the Safran-Isba-Modcou hydrometeorological suite, *Hydrol. Earth Syst. Sci.*, 14, 459-478.

¹ The downscaling method was developed by Pagé et al. (2009) ; <http://www.cerfacs.fr/~page/scratch/>

Detecting meteorological drivers behind inter-annual crop yield variability in France

A. Ceqlar – G. de Santis- A. Toreti– R. Lecerf– M. van der Velde– F. Dentener

European Commission, Joint Research Centre, Institute for Environment and Sustainability

Introduction

Prevailing climatic conditions underpin the suitability of agriculture to produce food, feed, fuel and fiber. At the same time agricultural production is greatly affected by weather extremes and climate variability. Understanding the relationship of climate variability with past crop production is of high importance to assess the resilience of our agricultural production systems to future climate conditions as well as the identification of adequate measures to adapt to climate change.

The main objective of this study is to identify the key meteorological variables and their period of maximum influence on the inter-annual variability of grain maize and winter wheat yields in France during crop growth season. We propose a statistical approach that is able to: tackle the problem of co-variation and provide information on the main intra-seasonal driving meteorological factors of crop yield inter-annual variability.

Materials and Methods

Time series (from 1989 to 2014) of grain maize and winter wheat yields from 92 French *départements* were provided by AGRESTE Ministère de l'Agriculture. Weather data were retrieved from the MARS Crop Yield Forecasting System (MCYFS) database, established and maintained by the Joint Research Centre for the purpose of crop growth monitoring and seasonal forecasting (Biavetti et al., 2014).

The locally weighted polynomial regression (LOESS) is here applied to de-trend the crop yield time series. The same procedure is also applied to all the other explanatory variables (temperature, precipitation and global radiation). A Partial Least Squares Regression (PLSR) approach is used to estimate the relationship between meteorological variables and crop yield time series. This method is useful especially when the number of explanatory variables is similar or higher than the sample size. In this study, the number of explanatory variables amounts to 18 (3 meteorological variables for 6 months of the growing season) and 30 (3 meteorological variables for 10 months of growing season) for grain maize and winter wheat, respectively.

Results and Discussion

In the case of grain maize, crop yields are mainly influenced by weather in July and August, even in irrigated regions (Figure 1). In large parts of southern, eastern and north-eastern France, summer temperature has been identified as the most important factor, with positive temperature anomalies leading to reduction in crop yields. Global radiation in the early growing season is the main factor over the westernmost part of

France. Grain maize yields in eastern France are not strongly affected by climate conditions in August. The rainfall effect on crop yield is difficult to detect in irrigated regions.

Winter wheat in most regions is more sensitive to weather conditions in late autumn/early winter (with the exception of some départements located in central and northern France), spring and in some cases early summer. The exact timing of the sensitivity, however, is highly variable across the country. Global radiation and precipitation in February seem to have an important positive influence on wheat yields over the central and western-most parts of France. Weather conditions in April and May, coinciding with the flowering period, have a relevant impact over the whole country, except the northern and north-western *départements*, where flowering occurs later. Overall, temperature has a substantial influence on winter wheat yields in the south-western and eastern parts of France, while rainfall is especially important over the northern and southern parts of the country.

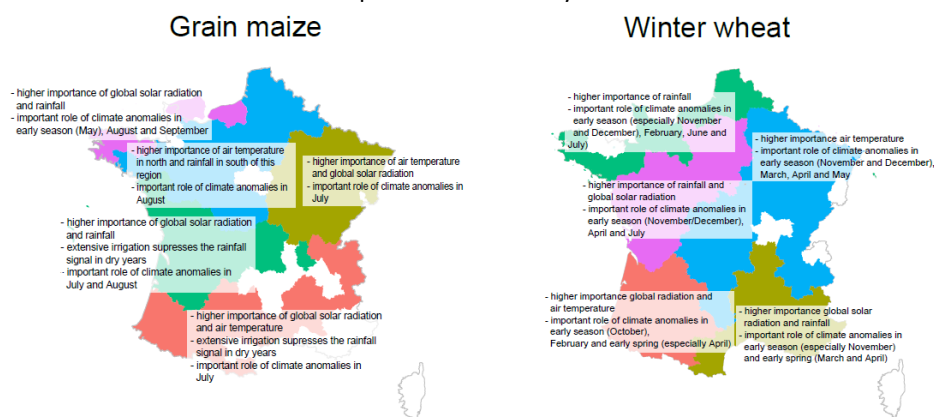

Figure 1. Identified meteorological variables and their significant influence on inter-annual variability of winter wheat and grain maize yields (Ceglar et al., 2015)

Conclusions

We have assessed the impact of intra-seasonal climate variability on crop yields in France at *département* level. For grain maize and winter wheat, apparent spatial differences have been observed in the timing of impact as well as in the meteorological variables having the highest relevance.

References

- Biavetti, I., S. Karetzos, A., Ceglar et al., (2014). European Meteorological data: contribution to research, development, and policy support. Proc. SPIE 9229, Second International Conference on Remote Sensing and Geoinformation of the Environment.
- Ceglar, A., A. Toreti, R. Lecerf et al., (2015). Impact of meteorological drivers on regional inter-annual crop yield variability in France. Agricultural and Forest Meteorology. Accepted for publication.

Characterizing the yield variability, yield gaps and yield loss risk of winter wheat in northern china

Y. Chen^{1,2*} – *Z. Zhang*¹ – *F. Tao*^{2,3} – *R. P. Rötter*^{2,1}

¹ State Key Laboratory of Earth Surface Processes and Resources Ecology/ Academy of Disaster Reduction and Emergency Management, Beijing Normal University, Beijing 100875, China

² Environmental Impacts Group, Natural Resources Institute (Luke), 01301 Vantaa, Finland

³ Institute of Geographical Sciences and Natural Resources Research, Chinese Academy of Sciences, Beijing 100101, China

* Corresponding author: Yi Chen. E-mail: chenym@mail.bnu.edu.cn.

Introduction

The increasing population and higher consumption on food will demand more rapidly increase of crop production in the next several decades. Meanwhile, because of the significant impact of agricultural activities on environment and climate changes, combine with the limitation of available land resources, improving crop productivity on existing cultivated land is in urgent need. In order to evaluate the potential of yield improvement and the possible food supply under sustainable intensification of agriculture production, it is essential to estimate the yield potential (Y_p) and the yield gap (Y_{gp}). Apart from closing the yield gap, mitigating the yield loss caused by climate changes will also significant benefit the yield increases. Information on yield loss risk will meet the demands of local adaptation. In this study, we conducted the analyses on field yield, yield potential, yield gaps and yield loss risk for winter wheat in north China.

Materials and Methods

China is the largest wheat producing country across the world. The main producing region concentrated in North China Plain (NCP) and Middle-lower Yangtze Plain (MLYP). Our study area covered these two plains and surrounding main cultivated areas, including 8 provinces and 2 municipalities. Totally 700 counties were covered. The study area accounted for 84% of sowing area and contributed 90% of winter wheat yield in China during the past decades. The combination of crop model and statistic analyses was applied in this study. Firstly, spatio-temporal pattern of field yield in county scale was analyzed. Then yield potential was simulated using MCWLA model and used to calculate the yield gaps under different management conditions. Finally, yield loss risk caused by climate changes was simulated. After these analyses, evaluation on closing yield gaps would be discussed.

Results and Discussion

Parts of results were shown in this paper. Based on the method proposed by Ray et al., (2012), field yield (Y_a) in most counties (about 61.1%) have kept increasing in recent period (Figure 1), while 30.1% of counties have already faced with yield stagnation. Mean Y_p ranged from 4000 - 9000kg/ha in north China, and showed increase trends in 42.5% of counties. Because of the lack of precipitation, winter wheat growth in north

China relied heavily on irrigation. Under the condition of rain fed, the yield potential with water limitation (Ypw) showed similar spatial pattern to precipitation. Meanwhile, the Ypw decreased to 2000-5000kg/ha. When considering the global warming and decrease of precipitation, it was not surprised that Ypw in more than 70% of counties have decreased. Comparison between Ya and Yp showed obvious gaps between the increase rates, which resulted in the ubiquitous decrease of Ygp in the past 30 years.

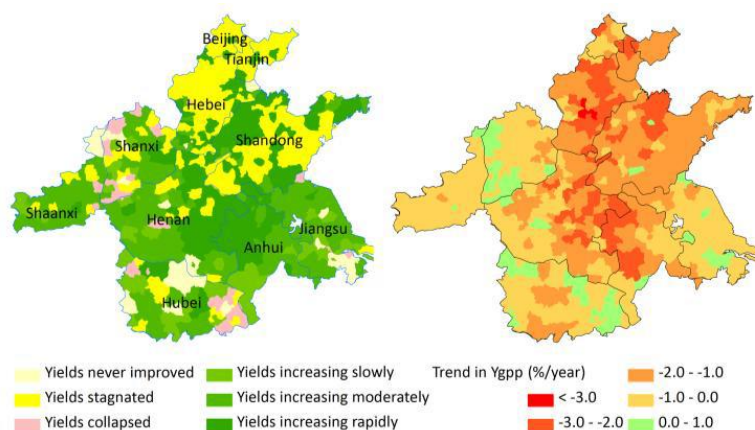

Figure 1. Trend type of yield field and the trends of Ygpp in county scale

To compare the decrease of Ygp among counties, Ygpp was used to indicate the percentage of Ygp in Yp. Decrease rates of 1-3% per year have been observed in major parts of NCP and MLYP (Figure 1). The impacts of climate variables such as temperature have also been analyzed. Using the simulation without stresses of climate variables, we can further present the potential risk of yield loss caused by climate changes, which will be useful to guide the crop adaptation and breeding.

Conclusions

The yield gap in north China has already faced with rapid decrease trends. There will be less space for yield improvement under current conditions. Closing yield gap is necessary for further getting more production. Meanwhile, applying adaptation technologies to mitigate the yield loss and improve the yield potential should be another hot issue.

Acknowledgements

This study was funded by the Fund for Creative Research Groups of National Natural Science Foundation of China (no. 41321001), the National Natural Science Foundation of China (no. 41571088 and no. 41571493), and the State Key Laboratory of Earth Surface Processes and Resource Ecology of Beijing Normal University (2014-ZY-06).

References

Ray, D.K., N. Ramankutty, N.D. Mueller et al., (2012). Nature communications 3: 1293.

Using crop modeling to get better field data

*K. Chenu*¹ – *A. Doherty*² – *J. Brider*² – *G. J. Rebetzke*³ – *G. McDonald*⁴ – *A. Mayfield*⁵ – *K. Bechaz*⁶ – *A. Pattison*⁷ – *M. Murfit*⁴ – *J. E. Mayer*⁸

¹ The University of Queensland, QAAFI, Toowoomba, QLD, Australia, karine.chenu@uq.edu.au

² Department of Agriculture and Fisheries, Toowoomba, QLD, Australia

³ CSIRO Agriculture Flagship, Canberra, ACT, Australia

⁴ Department of Agriculture and Food, Merredin, WA, Australia

⁵ Allan Mayfield Consulting, Clare, SA, Australia

⁶ Department of Primary Industries, Yanco, NSW, Australia

⁷ University of Sydney, Narrabri, NSW, Australia

⁸ Grains Research and Development Corporation, Canberra, ACT, Australia

Introduction

Water deficit affects to varying degrees different genes and physiological processes depending on the timing, intensity, duration and history (acclimation) of the stress. Genotype-environment interactions, which are impeding plant breeding, originate in part from these environmental variations in the timing and severity of the water deficit (e.g. Chenu et al., 2011), thus highlighting the importance of working in target environments when possible (Chenu, 2015). Managed-environment facilities were set up at three sites in Australia to assess trait and genotype value in representative environments. Despite the climate and soil at the three sites being representative of the three main cropping regions of the wheatbelt, strong year-to-year climate variability typically result in high variation in drought patterns depending on seasonal rainfalls. Overall, any of the four main drought environment types from the wheatbelt (Fig. 1a; Chenu et al., 2013a) are occurring at the three sites (Fig. 1b; Rebetzke et al., 2013). To target representative environments, all trials are being simulated over the crop cycle using crop modelling to monitor in-season development of water stress and to assist irrigation decision.

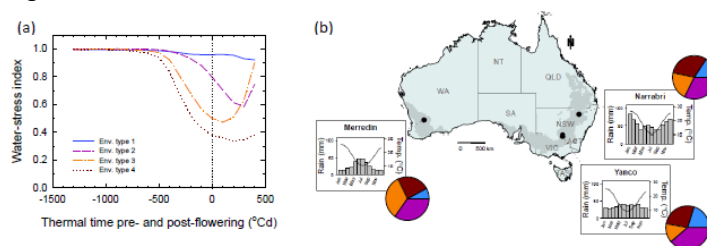

Figure 1. Water-deficit patterns of the main drought environment types identified in the wheatbelt (a) and climate characteristics at the three managed-environment facility (MEF) sites: Narrabri, Yanco and Merredin (b). (a) The waterstress index reflects how crops can meet their potential transpiration given soil water availability (an index of 1 indicates no water stress, while an index of 0 corresponds to no water availability to the crop). (b) Monthly cumulative rainfall (bars) and average temperature (lines) are given for the three sites, together with the frequency of occurrence of drought environment types 1-4 (pies) defined in (a).

Figures adapted from Chenu et al., (2013a) and Rebetzke et al., (2013).

Materials and Methods

The web application StressMaster was developed based on the crop systems model APSIM (Holzworth et al., 2014) to assist targeting representative drought patterns (Fig. 2; Chenu et al., 2013b). Using local soil characteristics, weather data and trial management, the application runs the APSIM-Wheat model to simulate crop growth and development and their interactions with the soil and climate. While in-site weather data allow simulations of the beginning of the season, local historical weather data are used to estimate likely end-of-the-season climate. Different irrigation scenarios can be tested to see their impact on the likelihood of drought pattern.

Results and Discussion

Since 2010, the managed-environment facilities have been targeting at each site (i) a severe water deficit (ET3-4; Fig. 1a) and (ii) a light-moderate water deficit (ET1-2). The StressMaster application is being used by site managers to assess the stress intensity over the season and anticipate likely drought scenarios. Using cropping modeling allows them to assess the effect of different irrigation scenarios as the season progresses and to make informed decision. While natural rainfall can prevent severe water deficit to develop some years, all four main environment types have been achieved at the MEF. Overall, the MEF allows a focus on detailed germplasm evaluation for a limited number of trials, while the assessment is performed in environments representative of the wheatbelt.

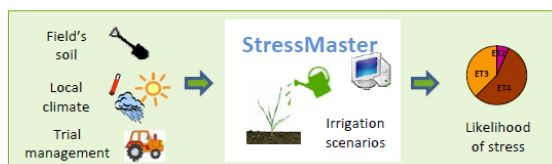

Figure 2. StressMaster, an application to assist target specific drought patterns in managed-environment facilities.

Conclusions

Crop modeling is being used to account for plant x soil x climate x management interactions and assist targeting representative drought patterns at managed-environment facilities. Here, the application of modeling allows promising lines to be evaluated in representative environments, thus increasing the resource efficiency for delivery to breeders.

References

- Chenu, K., Cooper, M., Hammer, G.L., et al., (2011). *Journal of Experimental Botany*, 62:1743-1755.
- Chenu, K., Deihimfard, R., Chapman, S.C. (2013a). *New Phytologist*, 198:801-820.
- Chenu, K., Doherty, A., Rebetzke, G., et al., (2013b). In: Sievänen, R., et al., 7th Conf. on FSPM, Saariselkä, Finland, 357-359.
- Chenu, K. (2015). In: Sadras, V.O. and Calderini, D.F. (eds) *Crop Physiology Applications* [...]. Academic Press, p 321:348.
- Holzworth, D.P., Huth, N.I., deVoil, P.G., et al., (2014). *Environmental Modelling and Software* 62:327-350.
- Rebetzke, G.J., Chenu, K., Biddulph, B., et al., (2013). *Functional Plant Biology*, 40:1-13.

Heat, frost and drought – what are the trends?

*K. Chenu*¹ – *B. Zheng*² – *J. Watson*¹ – *D. Lobell*³ – *S. Chapman*²

¹ The University of Queensland, QAAFI, Toowoomba, QLD, Australia, karine.chenu@uq.edu.au

² CSIRO Agriculture, St Lucia, QLD 4072, Australia

³ Dep. of Earth System Science and Center on Food Security and the Env., Stanford University, California 94305, USA

Introduction

Heat, frost, and drought – three abiotic stress factors that affect wheat production in Australia. Given the high year-to-year climate variability and the predicted changes in temperature and rainfall in the coming decades, what the expected trends in regards to stress affecting wheat? We used crop modeling to look at past and future impact of those abiotic stresses on Australian wheat.

Materials and Methods

The APSIM model (Holzworth et al., 2014) was used to simulate (i) long-term past and future drought patterns (Chenu et al., 2011 and 2013; Chenu, 2015; Watson et al., 2015), (ii) trends in frost impacts - after addition of a frost module to the model (Zheng et al., 2015a), and (iii) expected future heat impacts - after addition of a heat module (Lobell et al., 2015). Future simulations were performed for 33 general circulation models (GCMs), for 2030, 2050, and 2070, and for projected CO₂ concentrations of 449, 541 and 677 ppm, respectively.

Results and Discussion

Four main drought environment types were identified across the wheatbelt (Fig. 1a). While high year-to-year variability was observed, severe drought occurred with a 44% frequency on average for 1889-2011 (Fig. 1b; Chenu et al., 2013). Projections in the future revealed a lot of variability across GCMs, but severe droughts were projected to increase in the West while decreasing in the East for most climate models (Fig. 1c). Drought will nevertheless remain a major issue in Australia, with e.g. 45% of severe drought projected by 2050 for the West and 41% for the East, on average across GCMs.

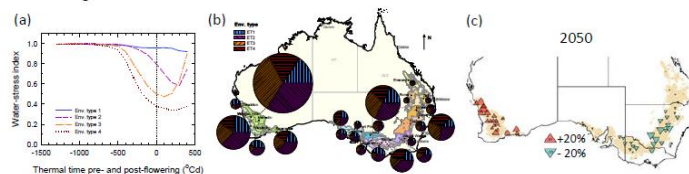

Figure 1. Water-deficit patterns of the main drought environment types (ET) identified in the wheatbelt (a), their historical frequency of occurrence for 1889-2011 (b) and projected changes for severe droughts (ET3-4) by 2050 (c). (a) The water-stress index reflects how crops can meet their potential transpiration given soil water availability (an index of 1 indicates no water stress, while an index of 0 corresponds to no water available to the crop). (c) Variations in ET3-4 (%) correspond to averages across 33 GCMs. Figures adapted from Chenu et al., (2013) and Watson et al., (2015).

Post head-emergence frosts are catastrophic events for wheat crops, as a single frost event has the potential to kill whole heads and their grains. Simulations indicated that frost costs up to 20% of yield, on average in Australia, through (i) direct frost damage (~10% cost) and (ii) the inability to use earlier sowing dates (adding a further 10% cost) (Zheng et al., 2015a). Over the last five decades, a significant decrease in yield ($P < 0.1$) was observed in about a third of the wheatbelt due to more frost days and/or a delay in last frost within the crop cycle (Fig. 2a). While counterintuitive, global warming may actually increase the risk of frost by accelerating wheat phenology, with heading time occurring earlier, during the frost-prone period.

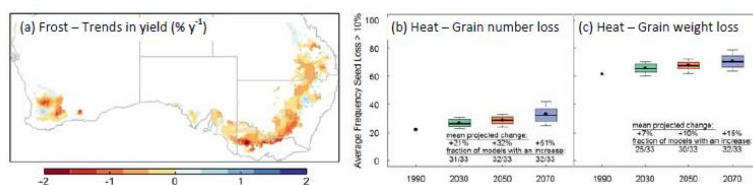

Figure 2. Frost and heat impact on wheat. (a) Trends in yield changes due to frost over the last five decades (from 1957 to 2013) in the wheatbelt (Zheng et al., 2015a). (b-c) Projected changes in heat impact due to pre-flowering (a) and post-flowering (b) stress in northeastern Australia (average over 33 GCMs; Lobell et al., 2015).

While heat stress is already impacting Australian wheat crops, global warming is projected to further impact crop production through (i) a hastening of crop development, i.e. a reduction in crop cycle and in potential yield (Zheng et al., 2012), (ii) a decrease in grain number (pre-flowering stress), and (iii) a decrease in grain filling (post-flowering stress) (Fig. 2b-c; Lobell et al., 2015).

Conclusions

Frost damage has increased over the last five decades in a third of the Wheatbelt. Increasing heat stress impact is expected in the East (not tested elsewhere yet). Increasing occurrence of severe droughts is projected mostly for the West in the coming decades, but overall the frequency of severe droughts will remain high across the whole wheatbelt. Current research is directed towards change in management (e.g. early sowing), long-season genotypes, and crop heat-, frost-, and drought-adaptation (e.g. Zheng et al., 2015a-b).

References

- Chenu, K., Cooper, M., Hammer, G.L., et al., (2011). *Journal of Experimental Botany*, 62:1743-1755.
- Chenu, K., Dehifard, R., Chapman, S.C. (2013). *New Phytologist*, 198:801-820.
- Chenu, K. (2015). In: Sadras, V.O. and Calderini, D.F. (eds) *Crop Physiology Applications* [...]. Academic Press, p 321:348.
- Holzworth, D.P., Huth, N.I., deVoil, P.G., et al., (2014). *Environmental Modelling and Software* 62:327-350.
- IPCC. (2007). IPCC, Geneva, Switzerland.
- Lobell, D.B., Hammer, G.L., Chenu, K., et al., (2015). *Global Change Biology*. In press.
- Watson, J., Zheng, B., Chapman, S.C., et al., (2015). 17th Australian Agronomy Conference, Hobart, Australia.
- Zheng, B., Chenu, K., Dreccer, M.F., et al., (2012). *Global Change Biology*. 18:2899-2914.
- Zheng, B., Chapman, S.C., Christopher, J.T., et al., (2015a). *Journal of Experimental Botany*. 66:3611-3623.
- Zheng, B., Chenu, K., Chapman, S.C. (2015b). *Global Change Biology*. In press.

Impact of maize management variability modeled as decision rules on yield and drainage at the regional scale

*J. Constantin*¹ – *J-E Bergez*¹ – *H. Raynal*² – *H. Hoffmann*³ – *F. Ewert*³

¹ INRA, UMR 1248 AGIR, Castanet F-31326 FR - Email: jconstantin@toulouse.inra.fr

² INRA, UR 0875 MIA-T, Castanet F-31326 FR

³ Crop Science Group, INRES, University of Bonn, Katzenburgweg 5, 53115 Bonn, DE

Introduction

Crop models are often applied at large scale to assess the impact of climate change on production for instance. Generally input data for models are not available all over the target area, and average values are often used. For management practices, fixed dates and quantities of inputs are used, whose values correspond to the mean of observed values over the region. However, management is highly variable within a region. The impact of this variability at such scale on model outputs is not well known. We assess the impact of management variability on crop model output at the regional scale for crop yield, water losses and as compared to a fixed management.

Materials and Methods

We selected a region in Germany, North Rhine-Westphalia (NRW), of ~34 000 km², for which we used climate and soil data at 1, 10, 25, 50 and 100 km resolution (Hoffmann et al., 2015) as input to the STICS crop model (Brisson et al., 2003). We simulated silage maize growth in NRW over 30 years (1982-2011), fertilized with nitrogen (N) in 2 dressings of 30 and 208 kg ha⁻¹ yr⁻¹ using fixed and adapted management dates.

For fixed management, sowing and first N dressing were on April 20th, the second N dressing on June 1st and harvest on September 20th. For adapted management, the sowing and fertilization dates were generated through decision rules independent of the crop model and harvest was simulated by the model. To choose the first possible date for sowing, we calculate the day for which the probability over 30 years to have frost (Temperature <-5°C) is null and the mean temperature in the 5 previous days of the year is above 8 °C. Then based on rainfall (*r*), we check each day if it rains more than 10 mm and if the soil is not too wet (*r* < 15 mm in the last 5 days) or too dry (*r* > 0 mm in the 10 previous days). If conditions are not met before May 10th, we force sowing at this date. For the 2nd N dressing, we calculate crop development stage as a sum of temperature (in base 6) since sowing. Fertilization on maize is often applied between the 6th and the 9th leaf. Considering that 80 °C·d are required for emergence and 45 °C·d for each leaf, we calculate the earliest date for fertilization since sowing. Then, each day, we check if the soil was not too wet and if it rained as for sowing. If these conditions are not reached at the 9th leaf, we forced fertilization.

Results and Discussion

The variability of sowing and fertilization dates was higher for finer than coarser resolutions due to a higher variability of climatic data. It resulted in slightly lower crop yields and higher water whatever the resolution of soil and climate, as compared to fixed dates. The standard deviation was almost the same for fixed and adapted management dates but extreme values were different particularly for drainage with lower minimum and higher maximum for adapted than fixed dates.

Table 1. Mean sowing and fertilization dates (with standard deviation), aboveground biomass and yearly drainage according to soil, climate and management resolution.

Soil x climate x management resolution (km)	Sowing date	2 nd N input date	Aboveground biomass (t ha ⁻¹)	Drainage (mm yr ⁻¹)
100 x 100 x fixed	20 April	1 June	13.7 ± 5.6	390 ± 152
100 x 100 x 100	19 April ± 6	12 June ± 9	13.1 ± 5.6	398 ± 155
10 x 10 x fixed	20 April	1 June	15.1 ± 5.0	434 ± 216
10 x 10 x 10	17 April ± 11	10 June ± 11	14.2 ± 4.8	447 ± 219

Adapting sowing dates results in earlier sowing in the south-west and extreme north-east of the region and slightly later dates in the south-east. The impact on aboveground biomass of maize was less than 1 t ha⁻¹ in average, except in the west where difference reached almost 4 t ha⁻¹. The pattern for drainage is less clear but a general trend of drainage increase with adapted dates appears.

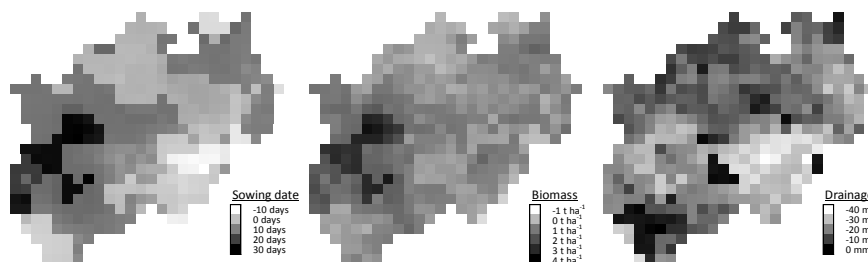

Figure 1. Mean differences over 1982-2011 of fixed and adapted management at 10 km resolution.

Conclusions

These preliminary results underline the interest to better understand the potential impact of using adapted management practices for crop model applications at regional scale. They should be extended to more models to confirm these results and other practices such as choice of crop maturity and nitrogen fertilization amounts.

Acknowledgements

This work within the project MACSUR was financially supported by: ACCAF INRA; German Federal Ministry of Food and Agriculture (BMEL) through the Federal Office for Agriculture and Food (BLE), grant 2851ERA01J.

References

- Brisson, N., Gary, C., Justes, E., et al., (2003). *Eur. J. Agron.* 18, 309–332.
 Hoffmann, H., Zhao, G., Van Bussel, L.G.J., et al., (2015). *Clim. Res.* 65, 53-69.

Calibration of the stics crop model for the portuguese grapevines

*R. Costa*¹ – *H. Fraça*¹ – *J. Moutinho-Pereira*¹ – *C. M. Correia*¹ – *L. Dinis*¹ –
*I. Gonçalves*² – *J. Silvestre*³ – *J. Eiras-Dias*³ – *A. C. Malheiro*¹ – *J. A. Santos*¹

¹ Centre for the Research and Technology of Agro-Environmental and Biological Sciences, Universidade de Trás-os-Montes e Alto Douro, 5000-801 Vila Real Portugal, rjncosta@utad.pt

² Associação para o Desenvolvimento da Viticultura Duriense, Quinta da Santa Maria, 5050-106 Godim, Portugal

³ Instituto Nacional de Investigação Agrária e Veterinária, I.P., Quinta da Almoinha, 2565-191 Dois Portos, Portugal

Introduction

Due to the specificities of grapevines (perennial crop), few dynamical crop models have been applied to this crop. One of them, is the STICS crop model (Brisson et al., 2003), which already includes calibrations for some international grapevine varieties (de Cortazar-Atauri, 2006). Nonetheless, STICS has not yet been tested or calibrated for the Portuguese winegrape varieties. The main objective of this study is to calibrate the STICS crop model for three main grapevine varieties in Portugal: Aragonez (Tempranillo), Touriga-Franca and Touriga-Nacional (AR, TF and TN).

Materials and Methods

To calibrate the model, historical phenological and yield component data for Aragonez (AR), Touriga-Franca (TF) and Touriga-Nacional (TN) were collected from several vineyards in the wineregions of Douro and Lisboa from 1990 to 2014. All the required variables for climate, soils, terrain and crop management techniques were collected at each vineyard and are presented in Table 1. Observed yields and phenological timings were then compared to STICS simulations.

Results and Discussion

Overall, results show that STICS provides a good accuracy in simulating grapevine phenology, yield components. For harvest, simulations show a relatively high accuracy $R^2=0.69$ (Fig. 1), which highlights the high modelling performance and quality for determining the harvest date. The STICS model also showed a high skill in simulating grapevine yield, with a $R^2=0.86$.

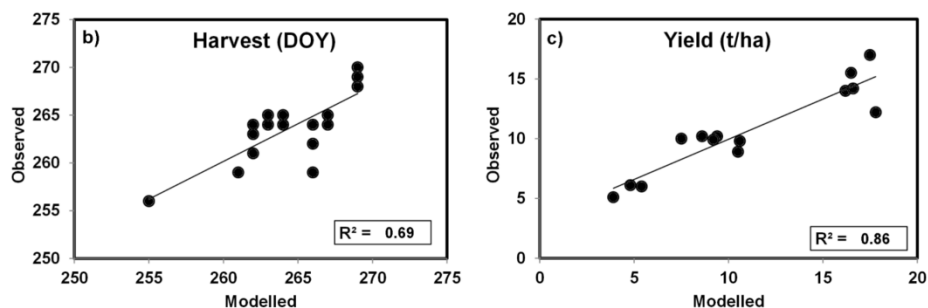

Figure 1. Scatterplots of the observed vs. modelled values for a) flowering (DOY), b) harvest (DOY), c) yield (t/ha), d) dry pruning weight (t/ha)

Table 1. Heat requirements and yield parameters as defined by STICS.

STICS Parameters	Douro			Lisboa		
	AR	TF	TN	AR	TF	TN
Stdordebou	4696	6707	5567	13887	12426	12417
Stamflax	696	808	707	1257	1194	1358
Stlevdrp	250	284	309	560	534	531
Stdrpnou	62	75	58	99	94	114
Dureefruit	1165	1111	1085	1208	1291	1269
Afruitpot	2.31	1.94	1.84	2.01	1.55	1.99
pgrainmax	2.30	1.98	1.48	2.30	1.98	1.48
Nbinflo	6	10	16	29	-	25
densitesem	0.55	0.3	0.3	0.3	0.3	0.3

Conclusions

The current study is a first approach to calibrate STICS to the Portuguese winegrape varieties. The model was successful in simulating yield and phenological timings. As such, we conclude that STICS can be used as a viable decision supporting tool for short-term strategic planning in the Portuguese viticulture.

Acknowledgements

This study was supported by national funds by FCT - Portuguese Foundation for Science and Technology, under the project UID/AGR/04033/2013. This work was also supported by the project "ModelVitiDouro" - PA 53774", funded by the Agricultural and Rural Development Fund (EAFRD) and the Portuguese Government by Measure 4.1 - Cooperation for Innovation PRODER program - Rural Development Programme.

References

- Brisson, N. et al., (2003). An overview of the crop model STICS. *Eur J Agron*, 18(3-4): 309-332.
- de Cortazar-Atauri, I.G. (2006). Adaptation du modèle STICS à la vigne (*Vitis vinifera* L.). Utilisation dans le cadre d'une étude d'impact du changement climatique à l'échelle de la France., PhD thesis, Montpellier, France, pp. 292.

The role of spatial pattern of soil types for data aggregation effects in crop modelling

*E. Coucheney*¹–*H. Eckersten*²–*P.E. Jansson*³–*F. Ewert*⁴–*T. Gaiser*⁴–*H. Hoffmann*⁴–*E. Lewan*¹

¹ Biogeophysics and water quality, Department of Soil and Environment, Swedish University of Agricultural Sciences, Lennart Hjelms väg 9, 750 07 Uppsala, SE, elsa.coucheney@slu.se

² Department of Crop Production Ecology, Swedish University of Agricultural Sciences, Uppsala, SE

³ Department of Land and Water Resources Engineering, KTH-Royal Institute of Technology, Stockholm, SE

⁴ Institute of Crop Science and Resource Conservation/Crop Science Group, University of Bonn, Bonn, DE

Introduction

Soil-crop models developed at field scale are increasingly used in large scale modelling for studying the impact of global changes on agro-ecosystems (Asseng et al., 2013). This introduces new sources of modelling uncertainty related to aggregation methods of input data (Zhao et al., 2015). Here we investigated the errors in yield, water drainage and N-leaching based on simulations with a detailed soil-vegetation model when aggregating soil input data from 1 km to 100 km resolution by area majority. The aim was to explore whether the error could be explained by the spatial pattern (spatial variability and spatial clustering) of identified key-soil types at the finest resolution.

Materials and Methods

The CoupModel (Jansson, 2012) was run to simulate wheat yield (Y , $t\ ha^{-1}$), annual water drainage (WD, mm) and nitrate leaching (NL, $kg\ N\ ha^{-1}$) for the NRW region in Germany with an average climate data time-series (30 years) and soil data at 1, 10, 25, 50 and 100 km resolution. Additionally, two alternative values of the soil organic matter decomposition (SOM) rate coefficient were tested. The error due to soil input data aggregation (the data aggregation effect, DAE) at the four coarser resolutions was quantified in terms of the rRMSE (%) as compared to the simulations at the finest resolution (1 km) (Zhao et al., 2015).

At the 1 km resolution, 2648 different soil profiles are covering the NRW region. Soil profiles were grouped into soil types according to the similarity in their input parameter values used in the CoupModel, i.e. soil depth, soil texture and soil organic carbon content, based on a hierarchical cluster analysis. The average values of the outputs were calculated for each soil type. A spatial variability indicator was assessed at 1 km resolution: the coefficient of variation (CV) between soil types weighted by their relative areas. To get several representations of this indicator, the analysis was repeated for 4 sub-areas within the region. The DAE at the different resolutions were thereafter related to this spatial indicator (Fig. 1).

Soils were grouped into 10 soil types of which 4 were associated with extreme values of simulated yield, water drainage and / or N-leaching. The DAE differed between different simulated variables, SOM specific decomposition rates (k) and sub-areas of the NRW region. At 10 km resolution, those differences could be related to soil type's

differences, weighted by their relative area (Fig. 1a). This relationship was however weaker at coarser resolutions (see example for Yield at 10 and 100 km, Fig. 1b).

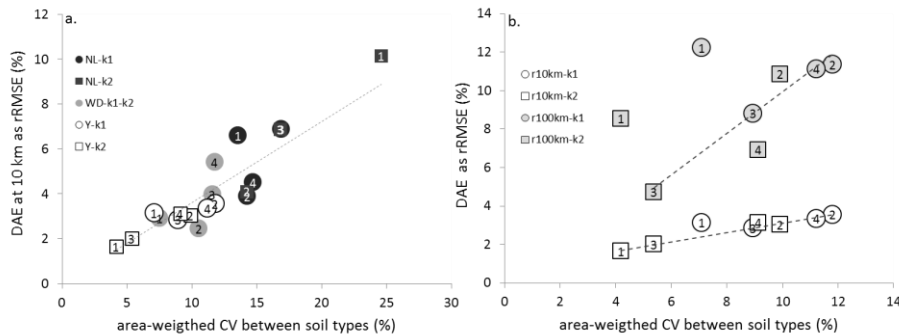

Figure 1. Relationship between the DAE and differences in mean outputs between soil types for the different variables (NL: N leaching, WD: water drainage, Y: yield), SOM decomposition rates (k1: circles k2: squares) and sub-areas (1 to 4). In figure 1a, the DAE is shown for the 10 km resolution while in figure 1b, the DAE is shown for 10 km (white) and 100 km resolution (grey) for Yield only.

Results and Discussion

The DAE at 100 km resolution for the yield in sub-area 1 was higher than expected when only considering differences in soil types (CV, Fig. 1b). This could be related to the low fraction in this area of shallow soils which were associated with extremely low yields (< 2.5 %, while > 4.5 % in other sub-areas).

Conclusions

These results suggest that a limited number of model-runs covering the range of soil types identified within a region, together with the relative area covered by each soil type at the fine resolution, might be used to estimate the DAE of different model output variables. However, the spatial pattern of different key soil-types within the region also needs to be taken into account and remains to be further investigated.

Acknowledgements

The study was conducted in the frame of the FACCE JPI MACSUR. It was supported by The Swedish research council FORMAS, the strategic funding "Soil-Water-Landscape" from the faculty of Natural Resources and Agricultural Sciences (SLU) and the German Federal Ministry of Food and Agriculture (BMEL) through the Federal Office for Agriculture and Food (BLE), grant no. 2851ERA01J'.

References

- Asseng, S., Ewert, F., Rosenzweig, C., et al., (2013). Nat. Climate Change, doi: 10.1038/nclimate1916
 Jansson, P. E., (2012). Transaction of the ASABE, doi: 10.13031/2013.42245
 Zhao, G., H. Hoffmann, L.G.J. Van Bussel et al., (2015). Climate Research, doi: 10.3354/cr01301.

An ontology for cropping system data management and modelling, based on system dynamics principles

*F. Danuso** - *F. Savian* – *F. Ginaldi*

Department of Agricultural and Environmental Sciences, University of Udine, Via delle Scienze 206, 33100, Udine (Italy). * corresponding author: francesco.danuso@uniud.it

Introduction

One threat that mostly occurs in scientific community collaborations is the possibility to rapidly transfer knowledge from one research group to another. The development of a widely accepted vocabulary and ontology for cropping systems (CS) is a way to increase research efficiency. Ontology allows also an easy and effective knowledge implementation in models using simulation platforms such as SEMoLa (Danuso and Rocca, 2014) and Bioma (Donatelli et al., 2012). Common standard vocabulary is an important pre-requisite to facilitate information exchange from CS databases to models, as pursued by AgMIP (Porter et al., 2012) and ICASA (White et al., 2013) initiatives. The aim of this paper is to propose an ontology that improves the long term agronomic experiment data management, as derived from the experience acquired with the IC-FAR project, and to present tools and procedures for data extraction and feeding different CS modelling solutions created using a modelling platform.

Materials and Methods

The project IC-FAR, granted by the Italian MIUR, initiated in 2013 with the aims to store data from 16 Italian long term agronomic experiments (LTEs) in a common, interoperable structure and to assess the reliability of different cropping system models over a wide range of Mediterranean environments and cropping systems. The LTEs are located in seven Italian sites, the oldest from 1960s, in a range between 41° and 45°N of latitude. The network of LTE involves many agricultural management practices concerning crop, cultivar, soil labour, fertilisation, irrigation, and other.

SEMoLa is a platform built around a non-procedural meta-language to create simulation models for continuous/event driven, deterministic/stochastic, state/individual based systems. It has been developed at the DISA, University of Udine (Italy) to simplify the tasks of: model building and documentation, simulation, sensitivity analysis, calibration, validation, data management, statistical analysis, neural network building and others. SEMoLa implements and extends System Dynamics ontology (Forrester, 1968) through a non-procedural declarative logic that makes model code easy to build and read, self-explaining and easy to debug.

Models written in SEMoLa language can be converted into DLL components to create modelling solutions or to make models available for other platforms (f.i., Bioma).



In the project three main strategies were pursued: i) developing a shared Excel DB based on AgMIP/ICASA vocabulary, ii) adopting the same terminology for CS models developed in SEMoLa and iii) developing a tool that thanks to a shared vocabulary, is able to create input files for model solutions created by SEMoLa components.

Results, Discussion and Conclusions

IC-FAR project information management steps (data entry and storage, extraction, modelling, simulation and model intercomparison) have required the development of different software tools (Fig. 1) and the adoption of modular approach in models creation. The main results referring to IC-FAR project are as follow:

1. *Storage*: ICFAR-DB formed by LTE data storage (LTE-DB), climate data storage (Weather-DB) and Management-DB, with standard parameters for each practice;
2. *Data extraction and interoperability*: Molinex (Model Input Extractor) application extracts data for modelling solutions created by SEMoLa platform, in CSV/SQL general format and for ACE-AgMIP system in the JSON format;
3. *Model development*: modelling platforms allow creating modelling solutions, combining reusable components via a model composer tool of SEMoLa;
4. *Model intercomparison*: performed by repeatable, updatable and transparent comparison procedures implemented as scripts of the same modelling platform.

In the ICFAR-DB, a specific hierarchical ontology has been created, particularly tailored to management practices, representing one of the most complicated issues.

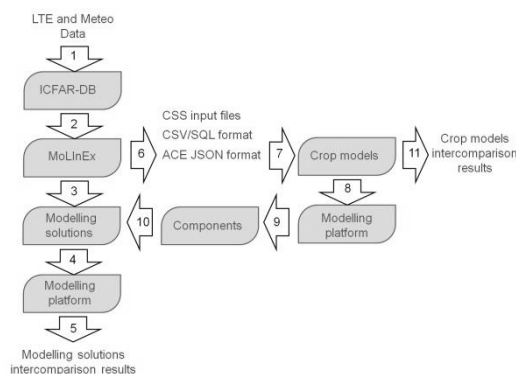

Figure 1. ICFAR information management system: 1. Data storage and site-based harmonisation; 2. Feeding Molinex; 3. Feeding new modelling solutions; 4. Simulation; 5. Results intercomparison; 6. Production of extractor output files; 7. Crop models feeding using translators; 8. Crop model knowledge re-implementation in modelling platform; 9. Model component creation; 10. Modelling solutions development.

Acknowledgements

This research has been funded by the MIUR PRIN 2010, Project IC-FAR, coordinated by Pier Paolo Roggero.

References

Danuso, F. and Rocca, A. (2014). Ecological modeling. 08/2014; 285:54–77.
 Donatelli M., Cerrani I., et al., (2012). In: Proc. of iEMSs, Sixth Biennial Meeting, Leipzig, Germany.
 Porter, C. H., Villalobos, C., Holzworth, D., et al., (2014). *Environmental Modelling and Software*, 62, 495-508
 Forrester, J.W. (1968). Principles of systems. Wright-Allen Press, Inc., Cambridge, MA.
 Danuso F. (1992). Stata Technical Bulletin, n.8, 19-32, Santa Monica, Computing Resource Center.
 White, J. W., Hunt, L. A. et al., (2013). *Computers and electronics in agriculture*, 96, 1-12.

**Assessing crop model performance in a critical food insecure region,
southern Africa, for improved modelling of climate risks
to food security**

D. Deryng^{1,2,*} – *D. Conway*² – *T. J Osborn*¹

¹ School of Environmental Sciences, University of East Anglia, Norwich, NR4 7TJ, UK

² Grantham Research Institute on Climate Change and the Environment, London School of Economics and Political Science, Houghton Street, London, WC2A 2AE, UK

* Corresponding author: d.deryng@uea.ac.uk

Introduction

The African continent, and more particularly Southern Africa (SA), is projected to experience some of the largest negative impacts of climate change on crop yields due to rising temperatures that are already on the upper-high end of crop tolerance thresholds, increasing occurrence of extreme weather events, greater variability in rainfall and subsequent shortages in water supplies (Zinyengere et al., 2013). Furthermore, SA remains a critical food insecure region: yields remain low whilst they have increased in other parts of the world during the 20th century “green revolution”; cropping systems are particularly vulnerable to extreme weather conditions and farmers’ adaptive capacity is poor. Crop models are useful tools for assessing risks posed by climate change in food production systems. In the last decade, there has been a growing interest in the development and application of global process-based crop models to (1) better understand the potential geographic distribution of yield losses and the means to alleviate them, (2) assess the role for agriculture, land cover and land use change activities on the global biogeochemistry cycles and (3) inform global food trade and agro-economic assessments. Despite the development of global agriculture datasets to support global crop yield simulations, little focus has been made to evaluate the performance of such models and datasets in SA. The gap in the quality of agriculture data as well as a greater range of simulated climate change scenarios in SA relative to other parts for the world impede crop model outputs are particularly unreliable in the region.

Materials and Methods

Model evaluation is key to model improvement. Our study aims to report an in-depth assessment of skills and causes of limitations of state-of-the-art global gridded crop models (GGCMs) and the accompanying agricultural datasets for conducting climate impacts, adaptation and vulnerability assessments for the agriculture sector in SA. We compare and analyse the performance of global gridded data and simulation results from the global gridded crop modelling intercomparison initiative (GGCMI), which includes a comprehensive ensemble of harmonised GGCM outputs and the most comprehensive ensemble of gridded agriculture and climate-reanalyses data products over the last 30 years (Elliott et al., 2014).

Results and Discussion

We compare the performance of crop models in simulating inter-annual yield variability for maize and explore potentials for model improvements and data requirements. The figure below introduces some of our results.

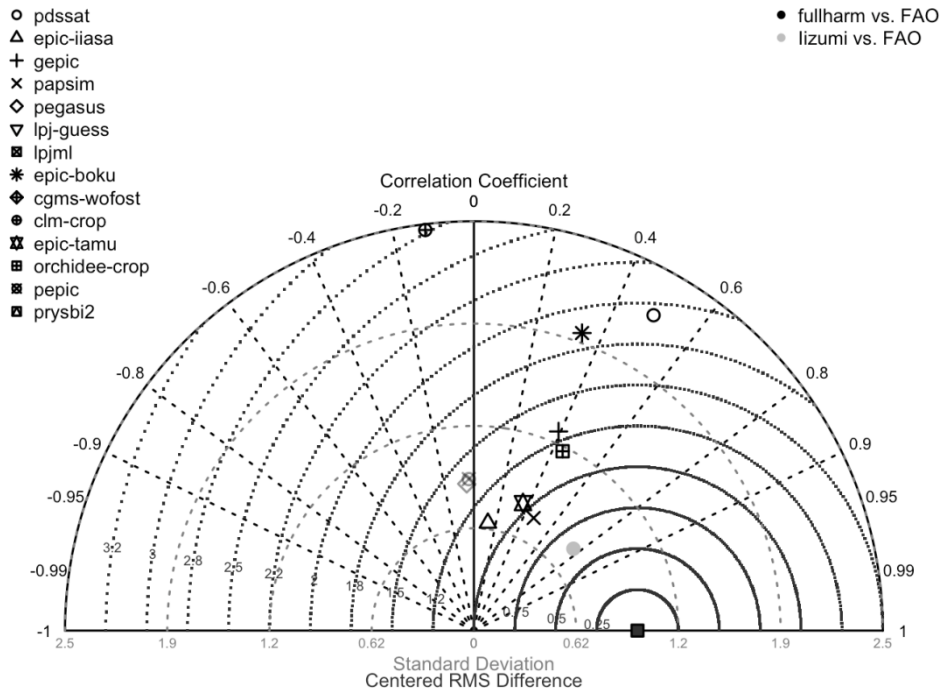

Figure 1. GCMs performance against FAO data in simulating inter-annual maize yield in SA (1980-2010).

Conclusions

These results target a new generation of agriculture impacts and adaptation research carefully designed to meet the needs of SA’s agricultural development and resilience in face of future climate change.

References

Zinyengere N, Crespo O, Hachigonta S. (2013) Crop response to climate change in southern Africa: A comprehensive review. *Global and Planetary Change*. Elsevier B.V; 2013 Dec 1;111(C):118–26.
 Elliott J et al., (2014) "The Global Gridded Crop Model intercomparison: data and modeling protocols for Phase 1 (v1.0)", *Geosci. Model Dev. Discuss.*, 7, 4383-4427, doi:10.5194/gmdd-7-4383-2014.

Performance of dssat-canegro and fao-agroecological zone models under operational Brazilian sugarcane Conditions

H. B. Dias – P. C. Sentelhas

Department of Biosystems Engineering, ESALQ, University of São Paulo, PO Box 09, Piracicaba, SP 13418-900, Brazil, e-mail: henrique.bdias@yahoo.com.br

Introduction

Sugarcane is cultivated across Brazil under different climates, soils and managements that impose different yield levels. Crop simulation models (CSM) for sugarcane can be used to evaluate a wide range of issues. However, crop management still remains a major challenge for CSM, such as mechanization, weeds, pests, diseases, and residues application (for instance, filter cake and vinasse). The aim of this study was to evaluate two sugarcane CSM: DSSAT-CANEGRO (Singels et al., 2008) and FAO Agroecological Zone Model (FAO-AZM; Doorenbos and Kassam, 1979) for a wide range of Brazilian sugarcane production systems and propose the use of a management factor, associated to the yield decay along the successive crop cycles (plant and ratoon) to improve the models performance.

Materials and Methods

The sugarcane crop models used were DSSAT-CANEGRO and FAO-AZM. DSSAT-CANEGRO is a process-based model that simulates growth, development, crop yield and other variables. The calibration for RB86-7515 cultivar from Marin et al., (2015) was used. FAO-AZM estimates attainable yield based on crop potential yield and the water deficit yield depletion in the different crop phases. The yield data, for both plant and ratoon crops, were obtained from different Brazilian mills located in different regions and conducted under rainfed and irrigated conditions, during 15 growing seasons. The irrigation method was dripping subsurface with the total water applied ranging from 500 to 2000 mm (full irrigation). The soils data were obtained from RADAM Brazil Project and ISRIC-WISE dataset (Romero et al., 2012). The weather data were obtained from the closest stations. An empirical management factor, called here as decay factor (kd), was proposed for both models based on Bernardes et al., (2008). The factor expresses an exponential of stalk fresh mass (SFM, t ha⁻¹) loss along successive ratoons, according to the following equation: $SFM_n = SFM_1 \times n^{-kd}$; where SFM₁ is SFM simulated for plant cane and n is the number of cuts. Mean absolute error (MAE), root mean square error (RMSE), determination coefficient (R²), agreement index (d), and modeling efficiency (E) were used to evaluate the two CSM.

Results and Discussion

The kd values, adjusted to field data, ranged from 0.1 (best farmers) to 0.35 (worst farmers). Without kd, both CSM had difficulties to estimate SFM (Figure 1), with MAE greater than 20 and 30 t ha⁻¹ for DSSAT-CANEGRO and FAO-AZM, respectively. When

kd was applied, model performance improved considerably, with MAE decreasing to about 16 t ha⁻¹ and d increasing to more than 0.8 for both models (Figure 1).

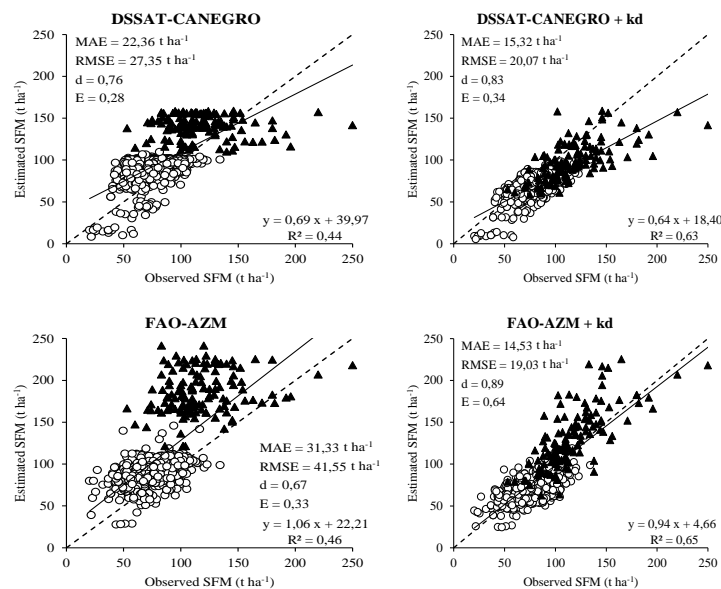

Figure 1. Performance of DSSAT-CANEGRO and FAO-AZM models for estimating sugarcane stalk fresh biomass under operational Brazilian conditions without and with decay factor (kd).

Conclusions

The introduction of the decay factor, due management, improved both CSM performance and should be used for yield simulations of sugarcane production systems.

Acknowledgements

We are grateful to Daniel Pedroso, from NETAFIM, and sugar mills for crop data. This study was supported by São Paulo Research Foundation (FAPESP), 2014/05173-3 process.

References

- Bernardes, M.S, W.P.V. Prellwitz, et al., (2008). Anais do 9º Congresso Nacional da STAB. Maceió, 906pp.
- Romero, C. C., Hoogenboom, G. et al., (2012). Environmental Modelling and Software 35: 163-170.
- Doorenbos, J. and A. H. Kassam (1979). FAO, Irrigation and Drainage Paper, 33. Rome, 179pp.
- Marin, F.R., P.J. Thorburn et al., (2015). Environmental Modelling and Software, 1: 1-15.
- Singels, A., M. Jones; M. van der Berg (2008). DSSAT v.4.5 DSSAT/CANEGRO: sugarcane plant module: scientific documentation. Mount Edgecombe, 34pp.

Interactive effects of CO₂ enrichment and N fertilization on grain N-acquisition and grain protein concentration in wheat

M. Dier – R. Manderscheid – J. Sikora – M. Erbs – H.-J. Weigel

Department of Biodiversity, Thünen-Institute, Bundesallee 50, 38116 Braunschweig, markus.dier@ti.bund.de

Introduction

A prominent feature of climate change is a rising atmospheric CO₂ concentration. Elevated CO₂ ([eCO₂]) increases growth and grain yield of C₃ crops, but decreases grain protein concentration (Taub et al., 2008; Myers et al., 2014) and therefore baking quality (Wieser et al., 2008).

In a two year FACE experiment we investigated the effect of [eCO₂] on the key processes determining grain N-acquisition and thus grain protein concentration. These key processes are the remobilization of N originating from pre-anthesis uptake and N acquisition during grain filling.

In order to detect possible interactions between [eCO₂] and N-fertilization, in both years we used three NO₃⁻ based fertilization regimens comprising one shortage, standard and excessive variant.

Materials and Methods

The experiment was conducted with winter wheat (variety "Batis") on a field site at the Thünen-Institute in Braunschweig in 2014 and 2015. The experiment consisted of three plots ("rings") with CO₂ free air enrichment ([CO₂] ~ 600 ppm) and three ambient plots ([CO₂] ~ 390 ppm). The fertilization variants were randomized within the plots.

NO₃⁻ based fertilization was carried out with calcium ammonium nitrate with 40, 180 and 320 kg ha⁻¹ in 2014 and 30, 200 and 320 kg ha⁻¹ in 2015.

Irrigation was carried out to keep usable field capacity in the range of 60 and 90%. In both years, crop growth and plant N-concentration was measured during five destructive harvests.

Results and Discussion

In 2014 [eCO₂] increased grain yield (Table. 1) by 12, 16 and 19% of the N-shortage, standard and excessive variant, respectively. Grain protein concentration of these variants were reduced by [eCO₂] by 2, 6 and 4%. The [eCO₂] effect on grain yield was in accordance with the results of other studies (Weigel and Manderscheid, 2012), but the [eCO₂] effect on grain protein concentration was much lower in comparison with others (e.g. Taub et al., 2008; Myers et al., 2014).

Table 1: Effect of [eCO₂] and N fertilization on grain yield and grain protein concentration.

N-fertilization	Grain yield (g m ⁻²)		Grain protein concentration (%)	
	Ambient CO ₂	High CO ₂	Ambient CO ₂	High CO ₂
40 kg ha ⁻¹	472	528	7.9	7.7
180 kg ha ⁻¹	817	949	10.6	10.0
320 kg ha ⁻¹	818	971	12.3	11.9

Similar to grain yield [eCO₂] increased the amount of N remobilized from the vegetative organs to the grain (13, 18 and 8% for the N-shortage, standard and excessive variant, respectively) and its efficiency, the amount of N remobilized to the grain divided by the amount of N at anthesis (Figure. 1). [eCO₂] did not have a significant effect on N-acquisition during grain filling. However, it increased post-anthesis N-acquisition at the N-excess variant by 26%.

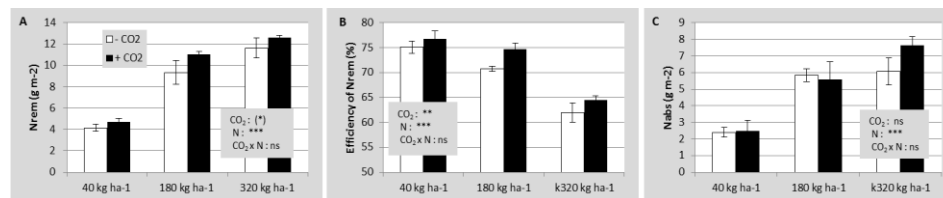

Figure 1: Effect of [eCO₂] and N fertilization on N-remobilization (A), its efficiency (B) and N-uptake during grain filling (C). ANOVA results for the CO₂ and N treatment: ns, not significant; (*), p < 0.1; **, p < 0.01; ***, p < 0.001.

Conclusions

Our data from the first year show, that [eCO₂] increased grain N-acquisition. This suggests that under field conditions of Central Europe grain protein concentration is only slightly affected by [eCO₂].

Acknowledgements

This project is funded by the German Research Foundation.

References

- Myers, S. S., A. Zanobetti, I. Kloog et al., (2014). *Nature*, 510: 139-143.
 Taub, D. R., B. Miller and H. Allen (2008). *Global Change Biology*, 14: 565-575.
 Weigel, H.-J. and R. Manderscheid (2012) *European Journal of Agronomy*, 43: 97-107.
 Wieser, H., R. Manderscheid, M. Erbs et al., (2008). *Journal of Agricultural and Food Chemistry*, 56: 6531-6535.

Pineapple cropping system design with the simpifiña modelling framework

*E. Dorey*¹ – *M. Rothe*² – *S. Pissonier*³ – *T. Michels*² – *P. Tixier*⁴

¹ UPR GECO, CIRAD, Bassin plat, 97455 Saint Pierre cedex, La Réunion, France, elodie.dorey@cirad.fr

² UPR HortSyst, CIRAD, Bassin plat, 97455 Saint Pierre cedex, La Réunion, France

³ UMR Innovation, CIRAD, 34398 Montpellier, France

⁴ Departamento de Agricultura y Agroforestería, CATIE, 7170, Cartago, Turrialba, 30501, Costa Rica

⁵ UPR GECO, CIRAD, CAEC, Quartier Petit Morne, BP 214 - 97285 Lamentin Cedex 2, Martinique, France

Introduction

It is a major issue to include field and farm constraints in model-based cropping system. Pineapple ('Queen Victoria' cultivar) is the first fruit to be produced on Réunion Island under a large range of climatic conditions and cultural practices. This implied a great variability on system performances (yield, fruit quality, N leaching). We designed a comprehensive model (Simpifiña) to simulate combinations of cultural practices (planting periods, planting density, weight of sucker, date of flowering induction, N fertilization and irrigation) that maximize agronomic, environmental (N leaching), fruit quality (acidity and sugar contents), and economical criteria in relation to climatic and structural constraints identified in a typology. We discussed the sensitivity of each cultural practice in the definition of sustainable systems and the gap between systems selected by the model and current systems for each type identified.

Materials and Methods

Plant growth and fruit development, affected by daily changes in soil N and soil water was determined with Simpiña model (Dorey et al., 2015). The sugar content and titratable acidity were simulated in two sub-modules linked to the plant growth module. We evaluated the grower's gain using an economic balance (Pissonnier et al., 2015). A typology of practices was performed in 39 farms representative of pineapple production on Réunion Island. SIMPIÑA was used to explore a wide range of practices combination in different locations, taking into account the constraints identified for each groups defined with the typology. Each combination of practices was evaluated for its: (i) agronomic performance (ii) fruit quality performance (iii) environmental performance, and (iv) economic performance

Results and Discussion

The typology led to three groups of farmers (A, B, and C) according to their location and the climatic conditions. We explored 8748, 34992 and 69984 systems with the Simpiña model and we selected 81, 77, and 101 systems that satisfy all criteria for the 3 types, respectively. Promising systems selected varied according to the farm-types identified (Figure 1). In farm-types A and B, systems selected showed earlier dates of flowering induction than current systems and N fertilization < 200 kg ha⁻¹. Inversely, in farm-type C, date of flowering selected was later than current systems and the level of

N fertilization is extended compared to farm-types A and B. There were some similarities between the 3 farm-types, e.g. most promising systems showed high performances with lower of N application. The level of N fertilization can probably be decreased in order to decrease N leaching while maintaining high yield. For the three farm-types, planting density was generally higher in the selected systems than in current ones. High sucker's weight also seems to improve performances of promising systems. The method used for selecting promising system is interesting because it did not generate a single solution, but range of combination of practices. This variability within practices selected highlighted that farmers could identify management recommendation which match with their objectives and strategic choices (Grechi et al., 2012).

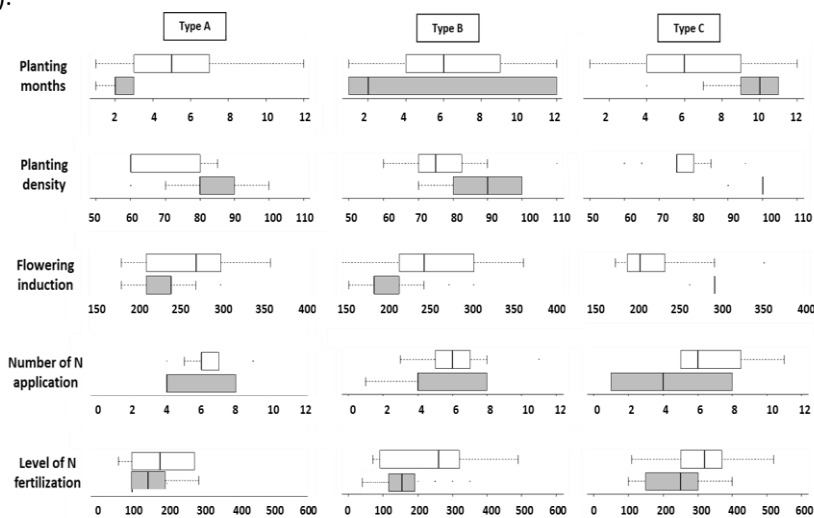

Figure 1. Representation of range of practices for actual pineapple system (white) and selected system (grey)

Conclusions

We demonstrated that a dynamic crop model that takes into account the key biophysical processes evaluated with a multi-criteria analyses associated with a typology of practices provide a useful framework for the design of innovative pineapple systems.

References

- Dorey, E., P. Fournier, M. Léchaudel, and P. Tixier. (2015). Validity of the pineapple crop model SIMPIÑA across the climatic in Réunion Island. *European Journal of Agronomy* 62:1-12.
- Grechi, I., Ould-Sidi, M. M., Hilgert, N., Senoussi, R., Sauphanor, B. and Lescourret, F. (2012). Designing integrated management scenarios using simulation-based and multiobjective optimization: Application to the peach tree-Myzus persicae aphid system. *Ecological Modelling* 246: 47-59.
- Pissonnier, S. (2015). Simulating impacts of marketing strategies on pineapple growers and grower organizations' profits on Reunion Island. In 'International Symposium on Innovation in Integrated and Organic Horticulture – Avignon, France 8-12 June 2015, in press.

Crop yields, soil organic carbon and soil nitrogen content change under climate change

B. Dumont^{1,*} - *B. Basso*¹ - *I. Shcherbak*¹ - *S. Asseng*² - *S. Bassu*³ - *K. Boote*⁴ -
*D. Cammarano*⁵ - *G. de Sanctis*⁶ - *J.-L. Durand*⁷ - *F. Ewert*⁸ - *S. Gayler*⁹ - *P. Grace*¹⁰ -
*R. Grant*¹¹ - *J. Kent*¹² - *P. Martre*¹³ - *C. Nendel*¹⁴ - *K. Paustian*² - *E. Priesack*¹⁵ -
*D. Ripoche*⁶ - *A. Ruane*¹⁷ - *P. Thorburn*¹⁸ - *J. Hatfield*¹⁹ - *J. Jones*²⁰ - *C. Rosenzweig*¹⁷

¹ Department of Geological Sciences, Michigan State University, MI, USA - ² Agricultural and Biological Engineering Department, University of Florida, Gainesville, FL, USA - ³ INRA-AgroParisTech, Thiverval-Grignon, France - ⁴ Department of Agronomy, University of Florida, Gainesville, FL, USA - ⁵ The James Hutton Institute, Invergowrie, Scotland, UK - ⁶ European Commission - Joint Research center, Ispra, Italy - ⁷ INRA-URP3F, Lusignan, France - ⁸ Institute of Crop Science and Resource Conservation (INRES), University of Bonn, Bonn, Germany - ⁹ WESS-Water and Earth System Science Competence Cluster, University of Tübingen, Tübingen, Germany - ¹⁰ Institute for Future Environments, Queensland University of Technology, Brisbane, Queensland, Australia - ¹¹ Institute of Crop Science and Resource Conservation (INRES), University of Bonn, Bonn, Germany - ¹² Natural Resource Ecology Laboratory, Colorado State University, Fort Collins, CO, USA - ¹³ INRA, UMR759 LEPSE, Montpellier, France - ¹⁴ Institute of Landscape Systems Analysis, ZALF, Leibniz-Centre for Agricultural Landscape Research, Muencheberg, Germany - ¹⁵ Institute of Soil Ecology, Helmholtz Zentrum München—German Research Center for Environmental Health, Neuherberg, Germany - ¹⁶ INRA-AGROCLIM, Avignon, France - ¹⁷ Climate Impacts Group, NASA Goddard Institute for Space Studies, New York, NY, USA - ¹⁸ CSIRO Ecosystem Sciences, Dutton Park, Queensland, Australia - ¹⁹ USDA-ARS National Soil Tilth Laboratory for Agriculture and the Environment, Ames, IA, USA - ²⁰ Department of Agricultural and Biological Engineering, University of Florida, Gainesville, FL, USA.

* 288 Farm Lane, Dpt. Geological Sciences, Natural Sciences Bldg., # 306, Michigan State University, MI, USA
Tel : +1-517-353-3472 – E-mail : bdumont@msu.edu

Introduction

It has been demonstrated that model ensembles is an efficient way to reduce the uncertainty associated with climate change impact on crop growth. (Asseng et al., 2015). Using such this approach, wheat and maize grain yields response to temperature increase were simulated by Asseng et al., 2015 and Bassu et al., 2014 using annually re-initialized soil conditions (soil water and nitrogen). Bassu et al., 2015, showed that by running models in a continuous mode, yield results differed from the annual reinitialized runs. In this study, we present the results of continuous model run of the AgMIP wheat- and maize-pilot under temperature and CO₂ changes and different management practices.

Materials and Methods

Five maize models and seven wheat models were run using a continuous mode under conventional tillage and no-till using the same factorials temperature, CO₂, rain and nitrogen fertilization levels of the AgMIP pilots (Asseng et al., 2015 and Bassu et al., 2014). We evaluate the range of response provided by the different models soil organic carbon (SOC) dynamic, soil nitrogen (N-NO₃⁻) and water dynamics under the maize-fallow and wheat-fallow crop rotations.

Results and Discussion

Under continuous running mode, models agreed in the direction of the changes for soil N-NO₃⁻ and SOC under the different temperature treatments. Furthermore, soil N-NO₃⁻ was found to increase and SOC was found to decrease with temperature increases. Consequently, important differences on simulated yields were observed between reinitialized and continuous run of the model. Fig. 1 compares the average model results under different CO₂ treatments and soil management practices for the continuous run. Whatever the temperature, yields were overall higher when CO₂ increased and lower when practicing no-till. Soil N-NO₃⁻ was lower under higher CO₂ concentration and was found to increase with temperature.

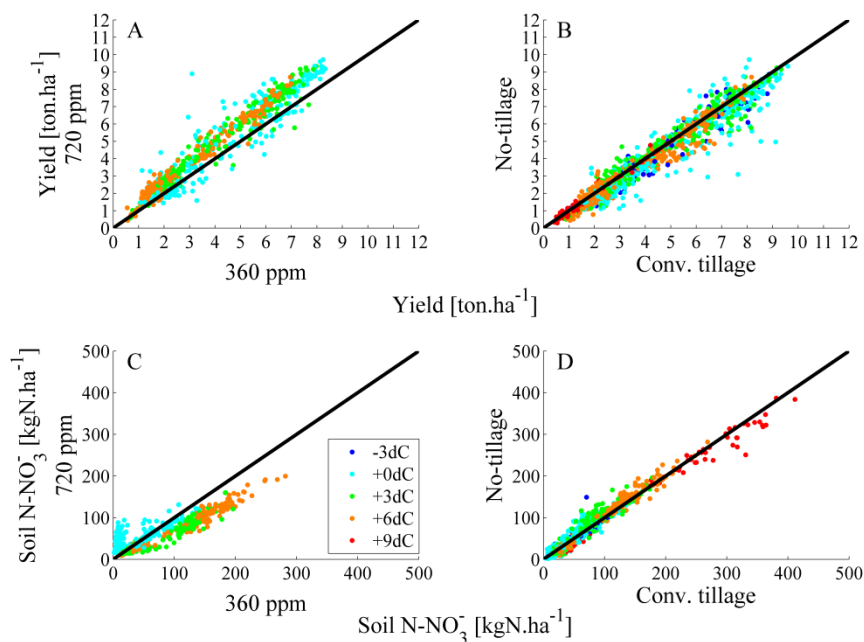

Figure 1. Wheat yield (A-B) and soil N-NO₃⁻ (C-D) content under different temperature (-3 to +9°C) treatments. Impact of CO₂ concentration (A-C) and tillage practice (B-D).

Conclusions

Continuous running mode of crop models appeared as a promising way to better understand the interactions between soil, climate and crop management. Such an approach is a promising mean to conceive crop and soil management strategies able to mitigate adverse climate change impacts.

References

- Asseng, S., Ewert, F., Martre, P. et al., (2015). Nature Clim. Change 5: 143-147.
 Bassu, S., Brisson, N., Durand, J.L., Boote, K. et al., (2014). Global Change Biology 20: 2301-2320.
 Basso B. et al., (2015). Plos One 10(6): e0127333.

Integrated assessment of climate change impacts on crop productivity and poverty rates: Case Study of the Bethlehem district in South Africa.

*W. Durand*¹ – *D. Cammarano*² – *O. Crespo*³ – *W. A. Tesfuhney*⁴

¹ Agricultural Research Council, Private Bag X1252, Potchefstroom, 2520, South Africa, DurandW@arc.agric.za

² The James Hutton Institute, Invergowrie Dundee DD2 5DA, Scotland, Davide.Cammarano@hutton.ac.uk

³ Environmental and Geographical Science Department, University of Cape Town, South Africa, olivier@csag.uct.ac.za

⁴ University of the Free State, PO Box 339, Bloemfontein, 9300, South Africa, weldit78@yahoo.com

Introduction

The Agricultural Model Inter-comparison Improvement Program (AgMIP) has developed a range of climate, crop, and economic modelling tools, protocols, and methodologies for integrating stakeholders' feedback for assessing the impacts of climate change on the agricultural systems at regional level (Rosenweig and Hillel, 2015). The approach was tested for the Bethlehem district in the Free State of South Africa.

Materials and Methods

The Bethlehem district was selected for this case study, because, it is representative of commercial farming systems. The study is mainly based on remote sensing identifying rainfed fields that have been planted to maize. Crop management inputs were obtained from objective yield surveys and soil input data from land type classification. Daily climate data was obtained from the University of Cape Town. Changes from the baseline climate (1980-2010) to mid-century (2040-2070) were computed under the RCP scenario 8.5 for five GCMs. Crop yield simulation were made using two crop models, DSSAT (Hoogenboom et al., 2012) and APSIM (Keating et al., 2003). Two agronomic adaptations to future climate were evaluated: increased application of fertiliser and a change in variety growth season length. Integrating the biophysical with the economic elements use was made of Representative Agricultural Pathways (RAPs) studying these using the TOA-MD economic model (Antle, 2014). The RAPs in this study was: Low Adaptation Challenges. Directions of change and magnitude of economic model inputs under this pathway were obtained from stakeholders through a series of meetings. Other socio-economic data for the district were obtained from surveys.

Results and Discussion

Analysis of the climate of the five GCMs for mean temperature, the GCMs agreed in terms of the direction (warming), however, for the rainfall there was higher uncertainty in both the amount and the direction of change, especially during summer. The average simulated maize grain yield for baseline climate (1980-2010) was

3155 kg ha⁻¹ with a CV of 49% between farms. Simulated grain yield using projected climate declined for both crop models and was estimated to be about 10% and 16% with DSSAT and APSIM, respectively. Adaptations increased simulated yields for both baseline and projected effects of climate. Economic analysis indicated that the per capita income would decrease between 10-27% in respect to the current levels and poverty rates would increase by between 2-3%. In future but without adaptation and with the assumptions made in the RAPs, indications are that the per capita income would decrease by between 5-27% while poverty rates would increase between 1-3%. If, however, the adaptations were taken into account, the net return per hectare was projected to increase between 12-18%, the per capita income would increase between 15-23% whilst the poverty rates would decrease between 12-22%.

Conclusions

This case study demonstrated that the integration between scientific skills in crop, climate, and economy to conduct detailed technical analysis along with the stakeholder engagement, which provided “reality-checks” in terms of technology trends, agronomic practices, policy and so on can offer an interesting alternative in the gaining information from integrated studies of climate change impacts.

Acknowledgements

This research was sponsored by USDA and UKAID. The authors would also like to acknowledge the coordination and leadership of AgMIP from Columbia University, the University of Florida and Oregon State and of NASA for the technical support.

References

- Antle, J.M., Stoorvogel, J. J., and Valdivia, R. O. (2014). New parsimonious simulation methods and 21 tools to assess future food and environmental security of farm populations, *Philos. Trans. R. Soc. Lond. B Biol. Sci.*, 369(1639), 20120280.
- Hoogenboom, G., Jones, J. W., Wilkens, P. W, Porter, C. H., Boote, K. J., Hunt, L. A., Singh, U., 44 Lizaso, J. L., White, J. W., Uryasev, O., Royce, F. S., Ogoshi, R., Gijsman, A. J., Tsuji, G. Y., 45 and Koo, J. (2012). Decision Support System for Agrotechnology Transfer (DSSAT)Version 4.5. 46 University of Hawaii, Honolulu, Hawaii.
- Keating, B. A., Carberry, P. S., Hammer, G. L., Probert, M. E., Robertson, M. J., Holzworth, D., 7 Huth, N. I., Hargreaves, J. N. G., Meinke, H., Hochman, Z., McLean, G., Verburg, K., Snow, 8 V., Dimes, J. P., Silburn, M., Wang, E., Brown, S., Bristow, K. L., Asseng, S., Chapman, S., 9 McCown, R. L., Freebairn, D. M., and Smith, C. J. (2003). An overview of APSIM, a model 10 designed for farming systems simulation, *Eur. J. Agron.*, 18, 267–288.
- Rosenzweig, C., and D. Hillel, 2015: Major findings and future activities. In *Handbook of Climate Change and Agroecosystems: The Agricultural Model Intercomparison and Improvement Project (AgMIP)*, Part 2. C. Rosenzweig, and D. Hillel, Eds., ICP Series on Climate Change Impacts, Adaptation, and Mitigation Vol. 3. Imperial College Press, 411-426.

Modelling sowing date of winter wheat in response to climate change for eastern Austria

E. Ebrahimi¹ – A. M. Manschadi¹ – R. Neugschwandtner¹ – J. Eitzinger² – S. Thaler² – H.-P. Kaul¹

¹ University of Natural Resources and Life Sciences, Dept. of Crop Sciences, Division of Agronomy, Konrad Lorenz-Str. 24, 3430 Tulln, Austria e-mail elnaz.ebrahimi@boku.ac.at

² University of Natural Resources and Life Sciences, Dept. of Water - Atmosphere - Environment, Institute of Meteorology, Peter Jordan-Str. 82, 1190 Vienna, Austria

Introduction

Climate change is expected to cause a decrease in wheat (*Triticum aestivum* L.) production in central Europe (Gouache et al., 2012; Kersebaum and Nendel 2014). Achieving demanded yield under future condition requires the development of management strategies such as increasing fertilizer efficiency by matching N application time to crop developmental stage and weather. Mechanistic crop growth models such as APSIM (The Agricultural Production Systems Simulator), integrate current understanding of the physiological processes within a mathematical framework. When linked to long-term weather data, they provide a valuable tool for quantitative assessment of the impact of management interventions on crop growth in a much larger sample of environments than is possible experimentally (Keating et al., 2003; Stöckle et al., 2003; Manschadi et al., 2006; Nelson et al., 2010, Asseng et al., 2000; 2014). The objectives of this study was to assess the impacts of climate change on optimum crop management in terms of sowing date and N fertilization (timing and rate).

Materials and Methods

Previously evaluated APSIM was run with the 100-year stochastic daily weather series for baseline (BL, 1981-2010) as well as those generated by the two Global Circulation Models (IPCM4 and MPEH5) under either A1B (536 ppm CO₂) or B1 (490 ppm CO₂) emission conditions. A factorial combination of sowing date (SD) and nitrogen fertilizer (N) treatment was used in all simulation runs. Wheat was sown on Sep 20, Oct 20, and Nov 20 and fertilized with 80, 120, 160, and 200 kg N ha⁻². Ratios of 40-40-0, 40-40-40, 50-50-60, and 60-60-80 kg N ha⁻² was applied at Zadoks stages 21 (beginning of tillering), 31 (beginning of stem elongation), and 51 (beginning of heading), respectively (see e.g. Ebrahimi et al, 2015).

Results and Discussion

With the BL, the earliest sown crops (SD1) were fertilized on average 67 and 203 days after sowing (DAS) for the N80 treatment. For higher N rates, an additional application was performed 233 DAS. Under IPCM4-A1B, the first N application was on average up to one month (19-29 d) earlier than that for the baseline. With B1, the first N application occurred 7-20 d earlier than today (Fig.1). With view to SD, the simulation

results suggest that in eastern Austria planting wheat in late September is the best strategy under both current and future climatic conditions. Earlier sowing and use of longer season cultivars have previously been suggested as adaptive strategies to climate change (Olesen and Bindi 2002).

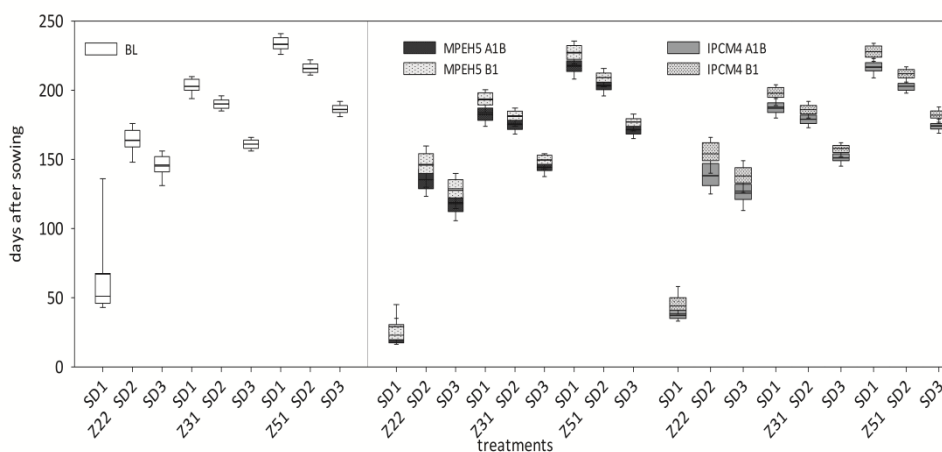

Figure 1 Simulated average days after sowing (DAS) of fertilizer application at target Zadok stages (Z21, Z31 and Z51) under baseline MPEH5 and IPCM4 weather with two emission scenarios (A1B, B1) as affected by sowing dates (SD).

The simulation results suggest that in eastern Austria planting wheat in late September is the best strategy under both current and future climatic conditions. An earlier sowing of wheat will even be more important in future, as delaying of planting to late October will be associated with a much larger reduction in grain yield due to shortening of growing season under climate change conditions compared to BL. modifying crop sowing date and amount and timing of N application may help to partially compensate adverse effects of climate change.

References

- Asseng, S., H. Van Keulen, W. Stol (2000). *European Journal of Agronomy* 12: 37-54.
- Asseng, S., F. Ewert, P. Martre et al., (2014). *Nature Climate Change* 5: 143-147
- Ebrahimi, E., A. M. Manschadi, et al., (Accepted sep. 2015). *Journal of Agricultural Science, Cambridge*.
- Gouache, D., X. Le Bris, M. Bogard, et al., (2012). *European Journal of Agronomy* 39: 62-70.
- Keating, B.A., P.S. Carberry, G.L. Hammer, et al., (2003). *European Journal of Agronomy* 18: 267-288.
- Kersebaum, K.C. and C. Nendel (2014). *European Journal of Agronomy* 52: 22-32.
- Manschadi, A.M., J. Christopher, P. Devoil, G.L. Hammer (2006). *Functional Plant Biology* 33: 823-837.
- Nelson, R., P. Kocic, S. Crimp (2010). *Environmental Science and Policy* 13: 18-27.
- Olesen, J.E. And M. Bindi (2002). *European Journal of Agronomy* 16: 239-262.
- Stöckle, C.O., M. Donatelli, R. Nelson (2003). *European Journal of Agronomy* 18: 289-307.

Data aggregation does not reduce signals of heat and drought stress in large area yield simulations

E. E. Rezaei^{1,2*} – *S. Siebert*¹ – *F. Ewert*¹

¹ Institute of Crop Science and Resource Conservation, University of Bonn, Katzenburgweg 5, D-53115 Bonn, Germany, *e-mail: eeyshire@uni-bonn.de

² Center for Development Research (ZEF), Walter-Flex-Straße 3, 53113 Bonn, Germany

Introduction

Spatial aggregation or averaging of climate and soil input data for crop models decreases the spatial variability of the data and may lower local extremes (Diffenbaugh et al., 2005). The current study objects to systematically investigate the effects of data aggregation on simulations of winter wheat yields considering explicitly heat and drought stress for the period 1980-2011 across Germany.

Materials and Methods

Daily climate data were obtained from the German Meteorological Service for the period 1980-2011 and soil properties were derived from the BÜK 1000 dataset. The climate and soil data were aggregated from the original 1 km × 1 km grids to 10 km × 10 km, 25 km × 25 km, 50 km × 50 km and 100 km × 100 km resolution across Germany. Heat and drought stress reduction factors and crop yield of winter wheat were simulated for all aggregations using the model SIMPLACE<LINTUL-2-CC-HEAT> but constrained to cropland areas in Germany according to the Corine Landcover 2006.

Results and Discussion

Spatial aggregation of input data showed a small effect (<4%change) on the mean of yield and on reduction factors for heat and drought stress simulated at country scale. However, the variability of model outputs declined with increasing aggregation (Figure 1).

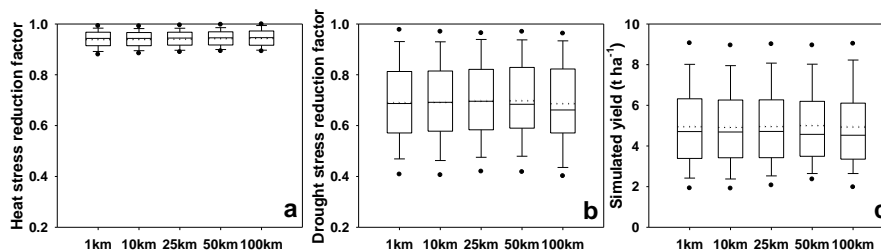

Figure 1. Boxplots of mean simulated heat (a), drought (b) stress reduction factors (for year 2003 considered as extreme year) reduction factors and yield (1980-2011) (c) at different resolutions across Germany. (Dashed line: mean, solid line: median; upper point and lower point show 5th and 95th percentiles, respectively)

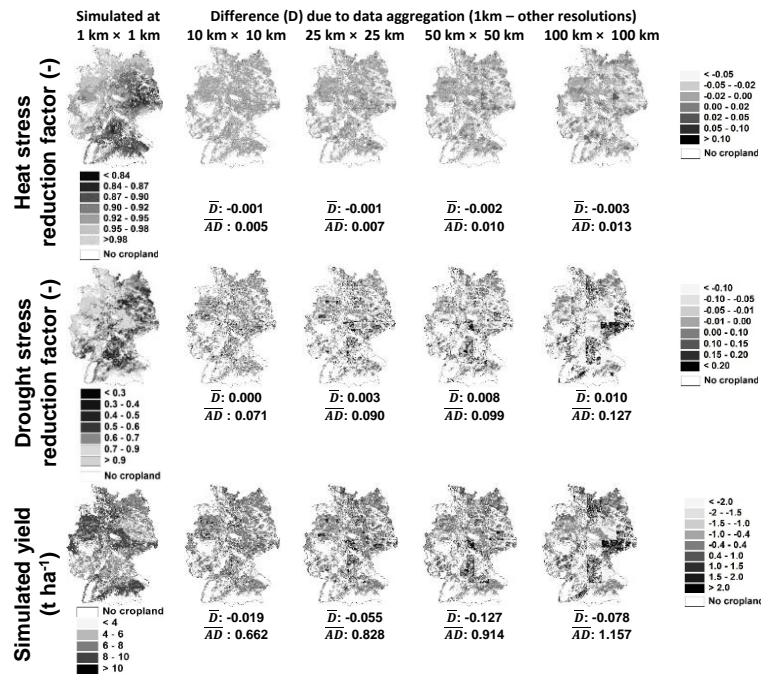

Figure 2. Impact of data aggregation on simulated heat, drought for year 2003 as extreme year and yield for the period 1980-2011 simulated at different spatial resolutions. (\overline{AD} : mean absolute difference at country scale and \bar{D} : mean difference at country scale)

Increasing the aggregation levels leads to a loss of spatial details of model outputs especially in heat and drought prone areas shown by mean absolute difference (\overline{AD}) at the country level (Figure 2). However, there was no remarkable change in mean difference (\bar{D}) across various aggregation levels caused by offsetting effects of positive and negative values (Figure 2).

Conclusions

We found that a high spatial resolution of input data is not necessarily needed to simulate mean crop yield under heat and drought stress across Germany. However, high resolution data improve spatial patterns of heat and drought effects on crop yield. (Rezaei et al., 2015).

Acknowledgements

Research support was provided by the German Research Foundation DFG (grant no. EW 119/5-1).

References

- Diffenbaugh, N.S., et al., (2005). Fine-scale processes regulate the response of extreme events to global climate change. *PNAS*, 102: 15774-15778.
- Rezaei, E.E., et al., (2015). Impact of data resolution on heat and drought stress simulated for winter wheat in Germany. *European Journal of Agronomy*, 65: 69-82.

Adapting the CSM-CROPGRO to simulate Chinese cabbage

T. Feike¹ – S. Munz² – Q. Chen³ – S. Graeff-Hönniger² – W. Claupein²

¹ Institute for Strategies and Technology Assessment, Julius Kühn-Institut | Federal Research Centre for Cultivated Plants, Stahnsdorfer Damm 81, 14532 Kleinmachnow, Germany, til.feike@jki.bund.de

² Institute of Crop Science (340a), University of Hohenheim, Stuttgart, Germany

³ College of Resources and Environmental Sciences, China Agricultural University, Beijing, China

Introduction

Chinese cabbage (*Brassica rapa* ssp. *pekinensis*) is the most important field grown vegetable of East Asia. In China, which is globally by far the largest producer, Chinese cabbage production is often characterized by excessive input intensities and low efficiencies (Chen et al., 2004). To evaluate opportunities for improving Chinese cabbage production, crop simulation models (CSM) are useful tools, which can help to understand the crop-soil-atmosphere interactions. So far no CSM for Chinese cabbage exists.

Therefore the aim of the present study was to adapt the process-based CSM-CROPGRO to simulate growth and development of Chinese cabbage. The generic structure of the CSM-CROPGRO, which was originally developed for field legumes, allows its targeted adjustment to new types of crops. By re-defining its cultivar, ecotype and genotype files, the model was adapted to different types of crops, including recent adaptations to pigeon-pea (Aldermann et al., 2015) and rapeseed (Deligios et al., 2013).

Materials and Methods

The adaptation built on the existing CROPGRO cabbage (*Brassica oleracea*) model. Based on a series of climate chamber, greenhouse and field experiments conducted in Germany and China from 2007 to 2010, the cardinal temperatures of the phenology and the photosynthesis model of CROPGRO were defined for Chinese cabbage, using leaf appearance rate and mean relative growth rate as key-variables, respectively. In the second step, the chemical composition of various plant tissues was defined according to published sources. Finally, specific cultivar, ecotype and genotype coefficients were adjusted systematically for the autumn sets from the Chinese experiment site following Boote (1999), minimizing the sum of squared errors between observed and simulated values. Measured data were available for head, leaf, stem and total above ground biomass, as well as leaf area index, specific leaf area, number of leaves and plant height and width. The model was validated based on four additional data sets from China and Germany.

Results and Discussion

The most relevant parameters, i.e., head dry matter, leaf area index (LAI) and specific leaf area (SLA) were predicted well over all six independent data sets.

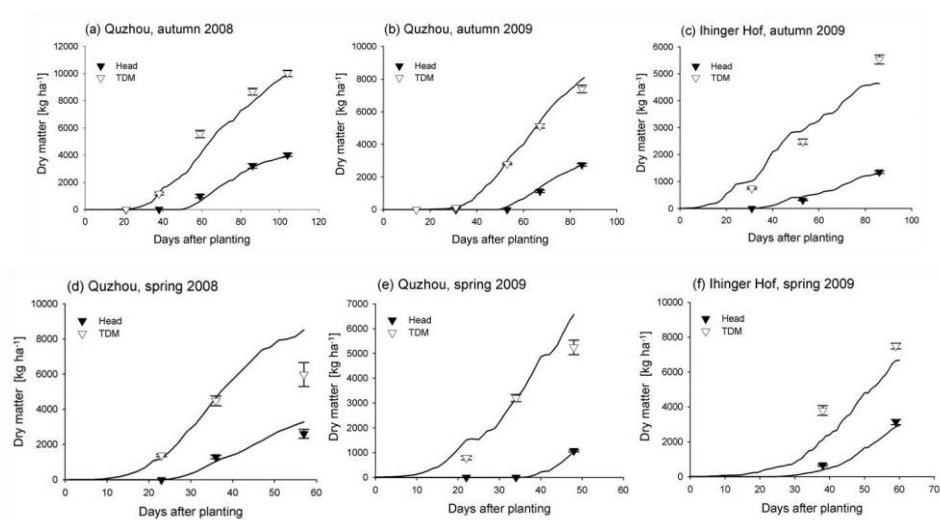

Figure 1. Simulated (lines) and observed (symbols) head and total above ground dry matter of six independent field data sets, used for calibration (aandb) and validation (c-f) of CROPGRO Chinese cabbage

While final head dry matters were simulated with deviations of less than 10% of actually obtained yields over all six data sets, certain inaccuracies occurred for the simulation of total above ground dry matters. Substantial underestimation occurred at the German site (cf. Fig.1 candf), and certain overestimation at the Chinese site (cf. Fig.1 dande). Future research may focus on integrating vernalization into CROPGRO-CSM.

Conclusions

The adapted CROPGRO-CSM proved valid for simulating growth and development of Chinese cabbage under the temperate climate conditions of Germany and China.

Acknowledgements

This research was funded by the German Research Foundation (GRK1070) and the Ministry of Education of the People's Republic of China.

References

- Alderman, P.D., K.J. Boote, J.W. Jones et al., (2015) Adapting the CSM-CROPGRO model for pigeonpea using sequential parameter estimation. *Field Crops Research* 181: 1–15.
- Boote, K.J. (1999). Concept for calibrating crop growth models. In: Hoogenboom, G., P.W. Wilkens and G.Y. Tsuji (Eds.), *DSSAT version 3. A decision support system for agrotechnology transfer*. Vol. 4, Univ. of Hawaii, Honolulu, HI, 179–200.
- Chen, Q., X. Zhang, H. Zhang et al., (2004). Evaluation of current fertilizer practice and soil fertility in vegetable production in the Beijing region. *Nutrient Cycling in Agroecosystems*, 69 (1): 51–58.
- Deligios, P.A., R. Farci, L. Sulas et al., (2013). Predicting growth and yield of winter rapeseed in a Mediterranean environment: Model adaptation at a field scale. *Field Crops Research* 144: 100–112.

Fuzzy-logic based multi-site crop model evaluation in europe

R. Ferrise¹ – M. Bindi¹ – M. Acutis² – G. Bellocchi³

¹ DISPAA, University of Florence, P.le delle Cascine 18, Florence, Italy, roberto.ferrise@unifi.it

² DiSAA, University of Milan, Via G. Celoria 2, Italy, marco.acutis@unimi.it

³ INRA-UREP, French National Institute for Agricultural Research-Grassland Ecosystem Research Unit, 5 Chemin de Beaulieu, Clermont-Ferrand, France, gianni.bellocchi@clermont.inra.fr
Corresponding author: roberto.ferrise@unifi.it

Introduction

It is agreed that the aggregation of metrics of different nature into integrated indicators offers a valuable way to assess models (Bellocchi et al., 2010). A composite indicator (MQI_m : Model Quality Indicator for multi-site assessment) was elaborated on metrics commonly used to evaluate simulation models, and on recent concepts of model evaluation integrating sensitivity analysis and robustness measures, as well as information criteria for model selection and expert judgments on the importance of different metrics. For wheat modelling in Europe, we document to what extent the MQI_m reflects the main components of model quality and supports inferences about model performances.

Materials and Methods

Five crop simulation models (CropSyst, DSSAT, HERMES, SIMPLACE, STICS), differing in processes and approaches used to represent the dynamics of crop phenology and growth, were applied to reproduce winter wheat development, aboveground biomass and yield at three experimental sites in Europe (Tab. 1).

Table 1. Sites and experimental setup (Kollas et al., 2015).

Site characteristics	Foulum	Müncheberg	Thibie
Country	Denmark	Germany	France
Latitude (decimal degrees North)	56.49	52.52	48.93
Longitude (decimal degrees East)	9.57	14.12	4.23
Climate type*	Atlantic North	Continental	Atlantic Central
Years of available data	2003-2012	1993-1998	1992-2003

* Metzger et al., (2005).

The performance of models was assessed using the MQI_m (<http://ojs.macsur.eu/index.php/Reports/article/view/D-L2.2/59>), which aggregates three components (modules) of model quality: agreement with actual data, complexity of the model, and stability of performance over a range of conditions (robustness). Using fuzzy logic-based weighting, a number of basic performance metrics were converted and aggregated into modules, which are dimensionless values between 0 (best model response) and 1 (worst model response). Then, the modules were aggregated in the final indicator (as well, dimensionless and in the range 0 to 1).

Results and Discussion

Limited to simulated grain yield, results show that the ranking of models may change depending on the metric considered (Tab. 2), thus confirming the need to aggregate several metrics to have a comprehensive view of model performance. MQI_m values >0.7 with all the models indicate that wheat yield is difficult to simulate, with high variability depending on the site (Robustness=1). Under the conditions evaluated, model 3 resulted the best-performing. Its performance was mainly due to a better agreement to data ($d=0.80$), achieved thanks to its high complexity (Complexity=1) owing to a relative high proportion of relevant parameters ($R_p>0.5$).

Table 2. Winter wheat yield simulations: performance metrics, modules and MQI_m calculated over three sites with five crop models. I_R : index of robustness (best, $0 \div \infty$, worst); $P(t)$: probability of paired Student t-test for means being equal (worst, $0 \div \infty$, best), d : index of agreement (worst, $0 \div 1$, best), R : Pearson's correlation coefficient of the estimates versus measurements (worst, $-1 \div +1$, best), R_p : relevant parameter ratio (best, $0 \div 1$, worst), w_k : ratio of Akaike's Information Criterion (worst, $0 \div 1$, best). For each basic metric, the upper line indicates the average value across sites. Greyed areas show the best value per metric.

Model	Performance metrics, modules and indicator					
	$P(t)$	\bar{r}	\bar{d}	\bar{R}_p	\bar{W}_k	I_R
1	0.22	0.30	0.50	0.32	2.10E-13	31.7
2	0.22	0.30	0.57	0.28	3.26E-10	66.7
3	0.42	-0.04	0.80	0.53	0.24	47.2
4	0.26	-0.05	0.27	0.50	0.76	176.7
5	0.29	0.20	0.43	0.37	1.07E-08	211.9
		Agreement		Complexity		Robustness
1		0.8182		0.7975		1.000
2		0.8182		0.7975		1.000
3		0.5000		1.0000		1.000
4		0.8000		0.5029		1.000
5		0.8000		0.8944		1.000
			MQI_m			
1			0.9128			
2			0.9128			
3			0.7500			
4			0.8060			
5			0.9504			

Conclusions

The aggregation of different aspects of model quality into a single indicator allowed ranking models from the best to the worst-performing. However, this is not a conclusive judging about the quality of models evaluated (kept anonymous). Rather, it is meant to help modellers identifying areas of their model requiring improvement.

Acknowledgements

Work supported by the FACCE JPI projects MACSUR and CN-MIP, and the EU-FP7 project MODEXTREME.

References

- Bellocchi G, Rivington M, Donatelli M, Matthews K (2010) *Agron Sustain Dev* 30:109-130
 Kollas C, Kersebaum KC, Nendel C, et al., (2015) *Eur J Agronomy* 70:98-111
 Metzger MJ, Bunce RG, Jongman RHG, Mucher CA, Watkins JW (2005) *Global Ecol Biogeogr* 14:549-563

AGRAGiS: Extending the NAGiS database within the agriculture sector

N. Fodor^{1,5} – L. Pásztor¹ – Z. Bakacsi¹ – F. Horváth² – B. Czúcz² – A. Zölei² – G. Illés³ – Z. Somogyi³ – A. Molnár⁴ – J. Szabó¹ – S. Koós¹

¹ Centre for Agricultural Research, Hungarian Academy of Sciences; e-mail: fodor.nandor@agrar.mta.hu

² Centre for Ecological Research, Hungarian Academy of Sciences

³ National Agricultural Research and Innovation Centre, Forest Research Institute

⁴ Research Institute of Agricultural Economics

⁵ Faculty of Biological Sciences, University of Leeds

Introduction

The agriculture related effects of climate change in Hungary would prospectively be mainly negative. The spectrum of mitigating factors is very wide comprising soil conservation techniques, automated precision irrigation, plant breeding and innovative ICT systems, as well. The overall objective of the National Adaptation Geo-information System (NAGiS) project is to create a multipurpose geo-information system that can support the policy-making, strategy-building and decision-making process related to the impact assessment of climate change and elaborating necessary adaptation actions for Hungary.

Materials and Methods

The AGRAGiS project aims at extending the NAGiS database within the agriculture sector (crop lands, grass lands and forests) by including new, 10×10 km resolution data and indicator layers (products) covering the area of Hungary. This objective could be broken down into the following goals (Fig. 1.): (1) Collection and creation of model input data using e.g. pedotransfer functions (2) Creation of agriculture related production, sensitivity, expected impact, adaptive capacity and vulnerability indicator data layers by using static (CASMOFOR: Somogyi 2010) and dynamic (4M: Fodor et al., 2014; Biome-BGC: Hidy et al., 2012) models combined with the latest downscaled future climate data based on the A1B scenario (IPCC, 2000). (3) Incorporation of AGRAGiS products and metadata into NAGiS.

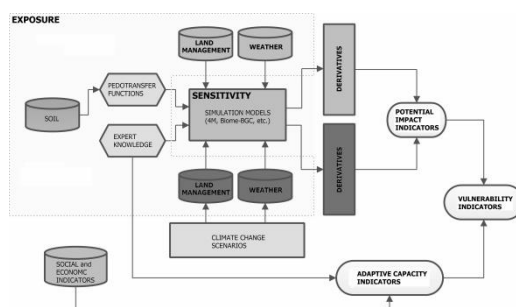

Figure 1. Flow chart of the AGRAGiS methodology.

The models were calibrated and validated by using high resolution soil (res.: 0,1×0,1 km; Pásztor et al., 2014) and climate (res.: 10×10 km; Spinoni et al., 2014) databases as well as decade long FADN data series (agromanagement and yield, 2001-2010) of 294 representatively selected Hungarian farms.

Results and Discussion

Vulnerability assessment was carried out by using the IPCC (2007) methodology. Modell based expected impact indicators and adaptive capacity indicators elaborated by using the ATEAM methodology (Schröter et al., 2004) was combined in order to determine agriculture related vulnerability indicator data layers. As a result of the assessment highly endangered (high expected impact + low adaptive capacity) and flexibly adaptive (high expected impact + high adaptive capacity) regions were located in Hungary. Based on model simulations short- and long-term adaptive management strategies (using irrigation, adaptive planting dates, etc.) were elaborated.

Conclusions

The AGRAGiS project results increase our understanding and awareness of climate change impacts and support policy and decision making processes in relation to adaptation to climate change. Scientifically well-founded climate change adaptation measures reduce human and ecosystem vulnerability to climate change and decrease the resulting economic and social costs.

Acknowledgements

The authors are grateful for the support of the EEA C12-12 Grant.

References

- Fodor, N., Pásztor, L., Németh, T. (2014). Coupling the 4M crop model with national geo-databases for assessing the effects of climate change on agro-ecological characteristics of Hungary. *International Journal of Digital Earth* 7: 391-410.
- Hidy, D., Barcza, Z., Haszpra, L., Churkina, G., Pintér, K., Nagy, Z. (2012). Development of the Biome-BGC model for simulation of managed herbaceous ecosystems. *Ecological Modelling* 226: 99-119.
- IPCC (2007). *Climate Change 2007: Impacts, Adaptation and Vulnerability. Contribution of Working Group II to the Fourth Assessment Report of the Intergovernmental Panel on Climate Change* (Ed.: Parry, M.L. et al.) Cambridge University Press, 976 pp.
- Pásztor, L., Szabó, J., Bakacsi, Zs., Laborczi, A., Dobos, E., Illés, G., Szatmári, G. (2014). Elaboration of novel, countrywide maps for the satisfaction of recent demands on spatial, soil related information in Hungary In: *Global Soil Map: Basis of the global spatial soil information system* (Ed.: Arrouays, D. et al.,) Taylor and Francis Group, pp. 207-212.
- Schröter, D., et al., (2004). *ATEAM (Advanced Terrestrial Ecosystem Analyses and Modelling) Final Report*. Potsdam Institute for Climate Impact Research, Potsdam.
- Somogyi, Z., Hidy, D., Gelybó, Gy., Barcza, Z., Churkina, G., Haszpra, L., Horváth, L., Machon, A., Grosz, B. (2010). Modeling of biosphere-atmosphere exchange of greenhouse gases: Models and their adaptation. In: *Atmospheric Greenhouse Gases: The Hungarian Perspective* (Ed.: Haszpra, L.), Springer, pp. 201-228.
- Spinoni, J. and the CARPATCLIM project team (39 authors) (2014). Climate of the Carpathian Region in 1961-2010: Climatology and Trends of Ten Variables. *Int. J. Climatol*, doi:10.1002/joc.4059.

Modelling climate change impacts for grapevine yield in Europe using the stics crop model

*H. Fraga*¹ – *I. G. de Cortazar Atauri*² – *R. Costa*¹ – *A. C. Malheiro*¹ – *J. A. Santos*¹

¹ Centre for the Research and Technology of Agro-Environmental and Biological Sciences, Universidade de Trás-os-Montes e Alto Douro, 5000-801 Vila Real, Portugal, e-mail: jsantos@utad.pt

² French National Institute for Agricultural Research, INRA, US1116 AgroClim, F-84914 Avignon, France

Introduction

Climate has a predominant role on growth and development of grapevine (Fraga et al., 2014; Jones et al., 2005; van Leeuwen et al., 2004). It is then clear that climate change is an unavoidable challenge for the winemaking sector. The present study aims to develop and analyse climate change projections for the viticultural yield in Europe. As such, the objectives of this study are to couple a dynamical crop model STICS (Brisson et al., 2008) with high resolution climatic simulations, for the recent-past and for future scenarios, in order to develop climate change projection for grapevine yield in Europe

Materials and Methods

In the present study, gridded climatic variables for minimum and maximum air temperatures, for the recent-past (1950-200) and for the RCP8.5 future scenario (2040-2060) are coupled with the STICS crop model (Brisson et al., 2008; Coucheney et al., 2015). For each grid-cell, in the European sector, soil characteristics (e.g. texture, depth) and terrain data are determined and used as model inputs. Grapevine and crop management variables are also defined within the model. STICS yield simulations for the recent-past and for the future are then compared and analysed to take into account the climate change impacts on European viticulture.

Results and Discussion

For the recent-past the STICS model is able to properly simulate yield for the current European wineregions, showing lower yields in Southern Europe and higher yield in more central/northern regions (Fig. 1 – left panel). For the future, the results depict an increase in yield in the later regions, and a decrease in the former, especially in inner Iberia (Fig. 1 – right panel). The projections also show an expansion of the potential grapevine growth areas northwards, which will lead to new regions suitable for winemaking in northern Europe (Fig. 2).

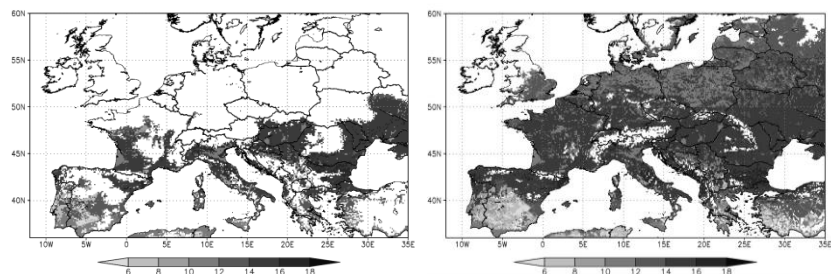

Figure 1. STICS simulations for yield over Europe for 1950-2000 (left panel) and 2040-2060 (right panel).

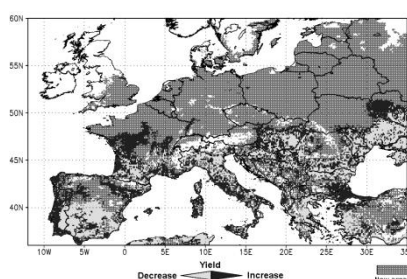

Figure 2. Differences (Future - Present: 2040-2060 minus 1950-2000) for yield simulations over Europe.

Conclusions

The current study is a first attempt to apply the STICS crop model to the whole spatial European sector, by using climatic, soil and terrain data as inputs. Additionally, by using climate change projections as crop model inputs, the results highlight the future changes in grapevine yield in Europe. These changes may bring significant challenges to the winemaking sector.

Acknowledgements

This study was supported by national funds by FCT - Portuguese Foundation for Science and Technology, under the project UID/AGR/04033/2013. This work was also supported by the project "ModelVitiDouro" - PA 53774", funded by the Agricultural and Rural Development Fund (EAFRD) and the Portuguese Government by Measure 4.1 - Cooperation for Innovation PRODER program - Rural Development Programme.

References

- Brisson, N., Launay, M., Mary, B. and Beaudoin, N. (2008). Conceptual Basis, Formalisations and Parameterization of the STICS Crop Model. Editions Quae, Versailles, France, 297 pp.
- Coucheny, E. et al., (2015). Accuracy, robustness and behavior of the STICS soil-crop model for plant, water and nitrogen outputs: Evaluation over a wide range of agro-environmental conditions in France. *Environ. Model. Software*, 64(0): 177-190.
- Fraga, H. et al., (2014). Integrated analysis of climate, soil, topography and vegetative growth in Iberian viticultural regions. *Plos One*, 9(9): e108078.
- Jones, G.V., White, M.A., Cooper, O.R. and Storchmann, K. (2005). Climate Change and Global Wine Quality. *Clim Change*, 73(3): 319-343.
- van Leeuwen, C. et al., (2004). Influence of climate, soil, and cultivar on terroir. *Am J Enol Vitic*, 55(3): 207-217.

Increasing boro rice production in saline coastal Bangladesh

*D. S. Gaydon*¹– *A. M. Radanielson*²– *Md. M. R. Khan*³– *A. K. Chaki*³– *Md. A. Rahman*³–
*Md. J. Kabir*⁴– *C. H. Roth*¹

¹ Commonwealth Scientific and Industrial Research Organisation (CSIRO), Brisbane, Australia

² International Rice Research Institute (IRRI), Los Baños, Philippines

³ n-Farm Research Division, Bangladesh Agricultural Research Institute (BARI), Joydepur, Bangladesh

⁴ Bangladesh Rice Research Institute (BRRI), Joydepur, Bangladesh

Introduction

In the saline coastal zones of Bangladesh, production of dry-season boro rice is limited by the availability of stored fresh water for irrigation. Consequently much of the land lies fallow, with dry season cropping occupying less than 10% of available area. Water available in the surrounding environment (rivers) becomes increasingly too saline for rice crop irrigation during the season. The possibility to mix saline and stored fresh water may offer an option to increase useable irrigation water volume and hence area of production for boro rice in this region. Decreased rice yield per hectare is expected under such management, however the total cropped area (and hence total rice production) could be increased. In this paper, we use crop modeling in combination with field experiments to examine tradeoffs between yield loss (t ha^{-1}) and cropping area increase (ha) to identify irrigation strategies which improve fresh water productivity (BGT ML^{-1}) and farm profit (BGT farm^{-1}).

Materials and Methods

A module accounting for rice crop salinity response was implemented inside the cropping systems model APSIM-Oryza (Radanielson et al., 2015; Gaydon et al., 2012a, 2012b). The model was calibrated and validated using two years of experimental data from Satkhira, Bangladesh for four (4) irrigation strategies, using fresh water, saline water, and two fresh-saline mixes. Long-term simulations were then performed using historical climate data for Satkhira, evaluating rice production and farm profit for a range of irrigation water mixing ratios. The control (rice variety BRRI-Dhan47 sown on 1-Jan) was compared with a range of treatments investigating changes to sowing date.

Results and Discussion

The APSIM-Oryza model was able to satisfactorily simulate observed rice production under different levels of salt stress and to capture the effect of the irrigation treatments on soil salinity. Under the control sowing date of 1 Jan, mixing saline water with stored fresh water at any ratio resulted in decreased farm profit, as yield loss from increasing salinity out-weighed cropping area gains. However the fresh-saline mixing strategy was shown to be very sensitive to sowing date, with significant gains in rice production and farm profit possible (Figure 1). Earlier sowing facilitated crop growth during periods of both greater yield potential and lower environmental salinity. A prerequisite is enhanced polder management practices to achieve the required early

drainage of stagnant water remaining from the wet season (the current cause of delayed boro rice sowing until 1-Jan). Whole-of-system cost-benefits require further study.

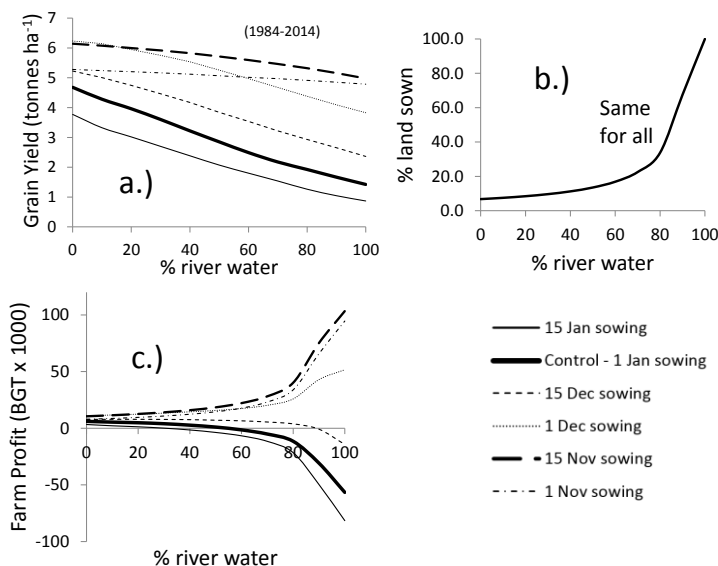

Figure 1. Boro rice production as a function of fresh-saline irrigation water mixing ratio (% river water is the saline component) and crop sowing date (for a medium sized farm (2 ha), values plotted are average 1984-2014), presented as a.) Grain Yield, b.) % land sown, and c.) Farm Profit (BGT)

Conclusions

Significant increases in boro rice production are possible in saline coastal Bangladesh using a strategy of early sowing with mixed fresh-saline water for irrigation. Improved polder management with early season drainage is a prerequisite to facilitate this earlier sowing. Extension of this method to other Rabi season crops, and extrapolation of these results to other salt affected regions in Bangladesh will help to establish potential gains in regional food production.

Acknowledgements

This work was supported by the Australian Centre for International Agricultural Research (ACIAR)

References

- Gaydon, D.S., Probert, M.E., Buresh, et al., (2012a). *European Journal of Agronomy* 39, 9-24.
 Gaydon, D.S., Probert, M.E., Buresh, et al., (2012b). *European Journal of Agronomy* 39, 35-43.
 Radanielson, A.M., Gaydon, D.S., et al., (2015). *Environmental Modelling and Software* (in review)

Yield gap analysis for Tanzania - The impact of Water supply and Fertilization on maize yields

C. Gornott – F. Hattermann – F. Wechsung

Potsdam Institute for Climate Impact Research (PIK)

Keywords

Tanzania, Maize yield gap, Water supply, Fertilization, Crop models.

Introduction

For Tanzania, food security will be the biggest challenge in the next decades. One dimension of food security is the production of food. Because of limited extendable arable land, the yield (per hectare) must increase to achieve a higher food production. Maize (*Zea mays* L.) is the most important food crop in Tanzania, although the average yield is below 1.5 t ha^{-1} . Field trials show that Tanzania has a large potential to increase the maize yield and enhance food security. An improvement of the plant nutrition due to a balanced fertilizer application can secure higher maize yields. In particular in regions with sufficient water supply, the potential for improvement is quite high.

Materials and Methods

Under optimal growing conditions, crop yields are determined by the solar radiation, the atmospheric CO_2 content, and the genetically potential of the crop. Under rainfed conditions, crops have frequently a non-sufficient water supply. These water limited yields (Y_w) suffer on water deficiency, but not on nutrient deficiency. Any divergence from the optimum nutrient supply and limited water supply are defined as water and nutrients limited yields (Y_n).

Crop models enable yield assessment for different management situations. For our yield gap analyses, we use the process based model SWIM (Soil and Water Integrated Model). Process based models calculate crop yields by the consideration of plant physiological impacts due to weather (solar radiation, temperature, precipitation) and agronomic practices (fertilization, irrigation). Furthermore, these models are able reproducing different management situation beyond the limits of the calibration dataset. In our analysis, we apply a concept of different yield levels (Y_w , Y_n) treated by different fertilizer application rates. These different fertilizer application rates are considered in the SWIM model to simulate the potential of fertilization for entire Tanzania.

Results and Discussion

For Tanzania, the water and nutrient limited yields (Y_n) calculated by SWIM are on average 1.5 t ha^{-1} , while the yields which only limited by the water supply (Y_w) archive 7.5 t ha^{-1} (Fig. 1). Field trails with analogous fertilization treatments show a high accordance to the SWIM yields. Generally, the optimal fertilization leads to a clear

increase of maize yields. However, there is also a strong spatial heterogeneity within Tanzania. In particular, in the Dodoma region (central Tanzania), the yields are highly water limited. Thus, the optimal fertilization leads only to a slight yield increase.

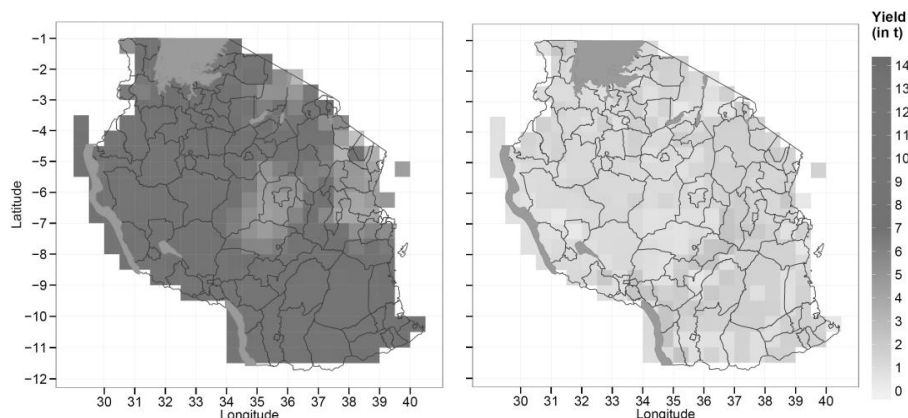

Figure 1: Water limited maize yields with optimal fertilizations conditions – Yw (left) and maize yields limited by water and nutrients supply – Yn (right). The black borders are the districts of Tanzania.

For entire Tanzania, the difference between Yw and Yn is on average 6.0t ha^{-1} . This can be interpreted as potential for improvement. This high potential for improvement can be explained by the low yield level of the Yn and by the fact that water supply often not limiting the crop yields. In central Tanzania, the difference between Yw and Yn is smaller; this could be explained by the low amount of precipitation in this region. The average yield gap of 6.0t ha^{-1} shows a potential for yield enhancements which is three times higher than the actual farm yields. The Yw calculated by SWIM based on an optimal nutrient supply over the whole growing period. However, temporal nutrient immobility or nitrogen leaching are not considered in the Yw calculation. Furthermore, the damaging effect of pests, weeds and diseases is not considered in SWIM. Nevertheless, the case of the neighboring country Malawi and the considered field trial data for Tanzania show that the tripling of maize yields might be possible.

Conclusions

The utilization of process-based model SWIM helps understanding the reasons of low yields and enables the development of agronomic practices, which enhance plant nutrient supply. A better understanding of the soil and plant nutrient dynamics allows the implementation of regional adjusted low cost management practices focusing either on water supply (e.g. tied ridges) or nutrient supply (e.g. micro-dosing of fertilizer).

Acknowledgements

The research was supported by the project Trans-SEC, which is sponsored by BMBF and co-financed by BMZ.

Potential growth of wheat-maize intercrop: model description and Bayesian parameter estimation

*F. Gou*¹ – *M. van Ittersum*² – *W. van der Werf*³

¹ Centre for Crop Systems Analysis, Wageningen University, P.O. Box 430, 6700 AK Wageningen, The Netherlands e-mail: fang.gou@wur.nl

² Plant Production Systems, Wageningen University

³ Centre for Crop Systems Analysis, Wageningen University

Introduction

Intercropping is attracting more attention around the world due to the advantages of high yield per unit land and potential for efficient resource uptake, resulting in reduced emissions. Field trials are frequently used to identify optimal systems in terms of species combination and planting pattern (Zhang et al., 2007; Agegnehu et al., 2008). In this research, we aim to build an intercrop model to explore yields potential under different climatic conditions, planting configurations and sowing dates.

Materials and Methods

Light interception in the intercrop was modelled with principles derived from a model for light interception in a block structured crop (Pronk et al., 2003). Field trials with different planting patterns (sole wheat, sole maize, wheat-maize intercrops with replacement or augmentative designs, as well as skip-row treatments) were conducted to collect data for model calibration. Bayesian estimation (Wallach et al., 2013) was used to find plausible ranges for key parameters for wheat and maize under different planting configurations.

Results and Discussion

Intercropping changed radiation use efficiency (RUE) and light extinction coefficient (k) in both wheat and maize (Table 1 and Figure 1). Crop biomass was simulated using the credible range of RUE and the modal value of k . The resulting average land equivalent ratio (LER) under potential growing condition for replacement intercrop was 1.27.

Table 1. Mean value and 95% credible interval of parameters and estimated biomass

Parameters	Sole wheat	Sole maize	Intercrop wheat	Intercrop maize
RUE (g /MJ PAR)*	2.50 (2.18, 2.82)	3.60 (3.32, 3.89)	2.76 (2.40, 3.12)	3.4 (3.08, 3.82)
k	0.60 (0.43, 0.77)	0.57 (0.42, 0.72)	0.62 (0.46, 0.78)	0.66 (0.50, 0.82)
Biomass (kg m ⁻²)	1.29 (1.07, 1.52)	2.328 (2.13, 2.53)	0.623 (0.51, 0.73)	1.830 (1.60, 2.06)

*RUE in the model represents radiation use efficiency of the crop under potential growing conditions (not water-limited).

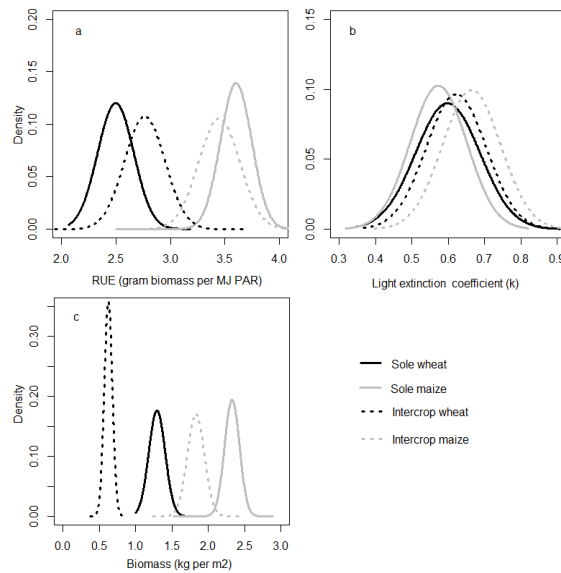

Figure 1. Density function of RUE, k and biomass for wheat and maize in sole crops and intercropping

Conclusions

This model captured light competition for strip intercropping system, which allows to explore plant performances under different crop combinations and planting configurations, and allows to benchmark intercropping systems: potential versus actual conditions and monoculture systems versus intercropping systems.

Acknowledgements

We are grateful to Dr Peter Leffelaar for helpful discussions and advices, and to Mr. Peter van der Putten, Dr Junqi Zhu, Mr. Yang Yu, Mr. Niel Verhoog and Wageningen UR Unifarm staff for valuable help during the experiments. The financial support of the China Scholarship Council (CSC) and the Key Sino-Dutch Joint Research Project of NSFC (grant number: 31210103906) are gratefully acknowledged.

References

- Agegnehu, G., Ghizaw, A. and Sinebo, W. (2008). Yield potential and land-use efficiency of wheat and faba bean mixed intercropping. *Agronomy for Sustainable Development* 28, 257-263.
- Pronk, A., Goudriaan, J., Stilma, E. et al. (2003). A simple method to estimate radiation interception by nursery stock conifers: a case study of eastern white cedar. *NJAS-Wageningen Journal of Life Sciences* 51, 279-295.
- Wallach, D., Makowski, D., Jones, J. et al., (2013). *Working with dynamic crop models*, 2nd edition, Academic press, 277-305 pp.
- Zhang, L., Van der Werf, W., Zhang, S. et al., (2007). Growth, yield and quality of wheat and cotton in relay strip intercropping systems. *Field Crops Research* 103, 178-188.

**Responses of soil nitrous oxide emissions and nitrate leaching on
climate, soil and management input data aggregation: a
biogeochemistry model ensemble study**

*E. Haas¹ – R. Kiese¹ – S. Klatt¹ – H. Hoffmann² – G. Zhao² – F. Ewert² – J. Constantin³ –
H. Raynal³ – E. Coucheney⁴ – E. Lewan⁴ – C. Sosa⁴ – R. Dechow⁵ – B. Grosz⁵ –
H. Eckersten⁶ – T. Gaiser² – M. Kuhnert⁷ – P. Smith⁷ – K. C. Kersebaum⁸ – C. Nendel⁸ –
X. Specka⁸ – E. Wang⁹ – Z. Zhao⁹ – L. Weihermüller¹⁰*

¹ Karlsruhe Institute of Technology (KIT), Institute of Meteorology and Climate Research – Atmospheric Environmental Research, Kreuzteckbahnstraße 19, 82467 Garmisch-Partenkirchen, DE

² Crop Science Group, INRES, University of Bonn, Katzenburgweg 5, 53115 Bonn, DE

³ INRA, UMR 1248 AGIR and UR0875 MIA-T, F-31326 Castanet-Tolosan, FR

⁴ Biogeophysics and water quality, Department of Soil and Environment, Swedish University of Agricultural Sciences, Lennart Hjelms väg 9, 750 07 Uppsala, SE

⁵ Thünen-Institute of Climate-Smart-Agriculture, Bundesallee 50, 38116 Braunschweig, DE

⁶ Department of Crop Production Ecology, Swedish University of Agricultural Sciences, Ulls väg 16, 750 07 Uppsala, SE

⁷ Institute of Biological and Environmental Sciences, School of Biological Sciences, University of Aberdeen, 23 St Machar Drive, Aberdeen AB24 3 UU, Scotland, UK

⁸ Institute of Landscape Systems Analysis, Leibniz Centre for Agricultural Landscape Research, 15374 Müncheberg, DE

⁹ CSIRO Land and Water, Clunies Ross Street, Canberra, ACT, AU

¹⁰ Institute of Bio- and Geosciences Agrosphere (IBG-3), Forschungszentrum Jülich, 52425 Jülich, DE

Introduction

Numerical simulation models are increasingly used to estimate greenhouse gas (GHG) emissions at site to regional scales and are outlined as the most advanced methodology (Tier 3) for national emission inventory in the framework of UNFCCC reporting. Low resolution simulations need less effort in computation and data management, but details could be lost during data aggregation associated with high uncertainties of the simulation results. This aggregation effect and its uncertainty will be propagated with the simulations. This paper aims to study the individual aggregation effects of climate, soil and management input data on soil N₂O emissions and nitrate leaching by an ensemble of different biogeochemistry models.

Materials and Methods

We simulated two 30-year cropping systems (winter wheat and maize monocultures) under nutrient-limited conditions. Climate and soil input data was based on a 1 km resolution, aggregated to resolutions of 10, 25, 50, and 100 km. Firstly, soil data was kept homogenous using representative soil properties while climate data was used on all different scales (see Hoffmann et al., 2015 and Zhao et al., 2015). In a second step, the climate data was kept homogeneous while soil initial data was used on all different scales. Finally, in a third step we have used spatially explicit climate and soil data on all different scales. We analyzed the N₂O emissions per unit of crop yield and the nitrate

leaching on the annual average as well as on daily resolution to study pulsing events for all scenarios and on all scales. The study was extended to assess the influence of management input data aggregation on the simulation results. The study presents an analysis of the influence of data aggregation on soil N₂O emissions and nitrate leaching for the state of North Rhine-Westphalia, Germany.

Results and Discussion

The study reveals the influence of input data aggregation on the nitrogen cycle and the losses of reactive nitrogen from managed ecosystems. While ensemble simulation results for micrometeorology and crop yield behave similar for the model ensemble, the response of the individual models for the prediction of soil N₂O emissions and nitrate leaching diverge significantly. This results from the structural differences of the biogeochemical process descriptions used within the model ensemble. The data aggregation effects on the nitrogen cycle across the scales were larger for the plain soil data aggregation compared to the plain climate input data aggregation. The aggregation effects across the scales on the nitrogen cycle for the model ensemble were more variable when using both climate and soil input data aggregation simultaneously. The variation between the wheat and the maize rotation was significant as the two crop rotations differ in nitrogen fertilizer input and plant nitrogen uptake which are the main drivers for the nitrogen cycle.

While the data aggregation of the agricultural management only addressed timings of individual management practices, their influence to the loss of reactive nitrogen were minor compared to the soil data aggregation.

Conclusions

The study gives an indication on adequate spatial aggregation schemes in dependence on the scope of regionalization studies addressing the quantification of losses of reactive nitrogen from managed arable systems.

Acknowledgements

The study was conducted in the frame of the Facce JPI MACSURE and received funding from several national institutions. Please see Hoffmann et al., (2015) and Zhao et al., (2015) for further details.

References

- Hoffman, H., G. Zhao, L.G.J. Van Bussel et al., (2015). Climate Research, doi: 10.3354/cr01326.
Zhao, G., H. Hoffmann, L.G.J. Van Bussel et al., (2015). Climate Research, doi: 10.3354/cr01301.

Environmental characterization for improving breeding strategies in Brazilian rainfed drybean

*A. B. Heinemann*¹ – *J. R. Villegas*^{2,3,4} – *K. J. Boote*⁵

¹ Embrapa Rice and Beans Rodovia GO-462 km 12 Zona Rural, 75375-000 Santo Antônio de Goiás, GO, Brazil, e-mail: alexandre.heinemann@embrapa.br

² International Center for Tropical Agriculture (CIAT), Km. 17 Recta Cali-Palmira A.A. 6713, Cali, Colombia

³ CGIAR Research Program on Climate Change, Agriculture and Food Security (CCAFS), Cali, Colombia

⁴ School of Earth and Environment, University of Leeds, Leeds, UK

⁵ Agronomy Dep., P.O. Box 110500, Gainesville, FL 32611, USA

Introduction

Common bean production in Brazil is concentrated in three distinct target population of environments (TPEs), representing the same geographic area in the Goiás state, but distinct growing seasons, namely, wet, dry and winter. In wet and dry TPEs, common beans are grown under rainfed conditions, whereas the winter sowing is fully irrigated. All varietal selection stages solely in the winter TPE, with rainfed environments being incorporated in the breeding scheme only through the multi environment trials (METs) where basically only yield is recorded. As yield is the result of many interacting processes, it is challenging to determine the events (abiotic or biotic) associated with yield reduction in the rainfed environments (wet and dry TPEs). We develop a characterization of environments and stress patterns that integrates weather, soil, crop and management factors using a crop simulation model, with the aim of producing information that can assist breeding strategies in their efforts to develop stress-tolerant high-yielding germplasm (Chenu, 2014; Heinemann et al., 2015).

Materials and Methods

The study region is located in the Goiás state, in central Brazil. Twenty-six sites with available daily weather data, i.e., precipitation, maximum and minimum temperatures and solar radiation, were selected. Three soil scenarios based on most prevalent agricultural soils, i.e. Oxisol (64% of total area), Ultisol (19%) and Inceptisol (6%) were created based on a Brazilian soil database, and then used to derive soil hydrological properties. The CSM-CROPGRO-DRY BEAN crop model was parameterized and evaluated for two standard check varieties, namely, Pérola and BRS Radiante. Crop simulations were then performed for a total of 13 (wet TPE: from 1 Nov to 30 Dec; dry TPE: from 10 Jan to 28 Feb) sowing dates across both rainfed seasons, for each of the 3 soil types, and 26 weather station regions for the period 1980-2013, using recommended agronomic practices for the region (row spacing) and assuming no nutrient limitations. Attainable (water and radiation-limited) simulated yield was used to identify environment groups in the two rainfed TPEs through cluster analysis. For each environment group, the main drought patterns were then determined by clustering the temporal variation of five-day-mean ratios of the water stress index (WSPD), calculated as the ratio of actual to potential transpiration.

Results and Discussion

We found two environment groups for the dry and wet TPEs, namely, highly favorable environment (HFE, 44 – 58 % of occurrence) and favorable environment (FE, 56 – 42 % of occurrence). Drought-stress free conditions were prevalent for the HFE (wet and dry season) and FE (only wet season) environment groups for both cultivars (profile [1] in Fig. 1). For FE (dry season), the predominant stress profile was terminal drought stress for both cultivars (profile [2] in Fig.1). We also found that for both rainfed TPEs the choice of sowing date is more important than the choice of cultivar for drought risk mitigation.

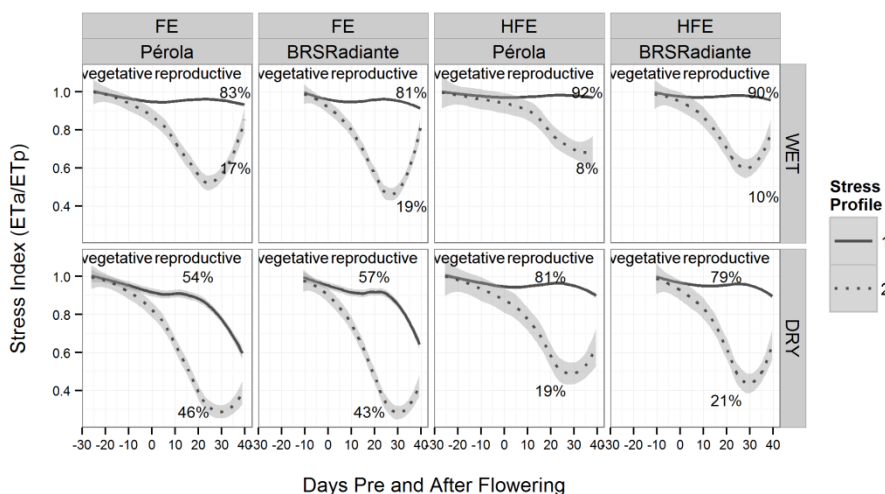

Figure 1. Drought stress patterns for favorable environment (FE) and highly favorable environment (HFE) for wet (top panel) and dry (bottom panel) common beans target population of environments. Numbers represents the frequency of occurrence of stress patterns in each environment group. Gray bands represent the 95% confidence interval around the average stress patterns. Stress profile legend for WET TPE: 1 – drought free profile and 2 –reproductive terminal drought stress. Stress profile legend for DRY TPE: 1 – terminal drought stress and 2 –reproductive terminal drought stress.

Conclusions

As a fraction of the rainfed TPEs, drought conditions occur roughly in one fourth of the seasons (23.9 % for Pérola and 24.7 % for Radiante). We conclude that for the rainfed TPEs, drought can be considered a main constraint only for dry season FE environment group. We argue that breeders should include drought response as part of the selection criteria in their trials.

References

- Heinemann AB, Barrios-Perez C, Ramirez-Villegas J, Arango-Londono D, Bonilla-Findji O, Medeiros JC, Jarvis A. (2015). *Journal of Experimental Botany* 66, 3625-3638.
 Chenu K. (2014). In: Sadras VO, Calderini DF, eds. Boston, MA: Academic Press, pp321-348.

Determination of the water balance of maize plants on lysimeters by means of sap flow measurement and plant growth models

F. Heinlein – C. Biernath – C. Klein – C. Thieme – E. Priesack

Modeling Soil-Plant-Atmosphere Systems, Institute of Biochemical Plant Pathology, Helmholtz Zentrum München GmbH – German Research Center for Environmental Health, Ingolstädter Landstraße 1, D-85764 Neuherberg, Germany, e-mail: florian.heinlein@helmholtz-muenchen.de

Introduction

In Central Europe expected major aspects of climate change are a shift of precipitation events and amounts towards winter months (Palmer and Räisanen, 2002), and the general increase of extreme events (Beniston et al., 2007) like heat waves or summer droughts (Folland et al., 2009). This will lead to a strongly changing regional water availability and have an impact on future growth, water use efficiency and yields of agricultural plants. Therefore, an accurate model description of transpiration as part of the water balance is important.

Materials and Methods

In this study, maize was grown on weighing lysimeters (sowdate: 24 April 2013), which measure evapotranspiration and percolation. Transpiration was determined by sap flow measurement devices (ICT International Pty Ltd, Australia) using the Heat-Ratio-Method (Burgess et al., 2001): two temperature probes 0.5 cm above and below a heater detect a heat pulse and its speed from which sap flow is calculated.

Water balance simulations were executed with six different applications of the model framework Expert-N (Priesack 2006). The same pedotransfer and hydraulic functions and the same modules to simulate soil water flow, soil heat and nitrogen transport, nitrification, denitrification and mineralization are used. Differences occur in the chosen potential evapotranspiration ET_{pot} (Penman-Monteith ASCE, Penman-Monteith FAO, Haude) and plant (canopy models SPASS, CERES) modules. In all simulations ET_{pot} is separated into a soil and a plant part using the leaf area index (LAI). In a next step, these parts are reduced by soil water availability. The sum of these parts is the actual evapotranspiration ET_{act} which is compared to the lysimeter measurements

Results and Discussion

Weather data exhibits diurnal cycles of temperature, wind speed and relative humidity. Maximum net radiation is 8000 W m^{-2} and a major rain event (25 mm d^{-1}) occurred on 25 August.

Modelled (Penman-Monteith ASCE, SPASS) and measured sap flow rates are presented in Figure 1. The measurements show clear diurnal cycles except on rainy days. The simulations also show diurnal cycles, but overestimate the measurements on the rainy days and underestimate them on the other days. The main reason is an overestimation

of potential transpiration T_{pot} due to too high LAI in the beginning. At the end, green LAI gets lower and T_{pot} is slightly underestimated.

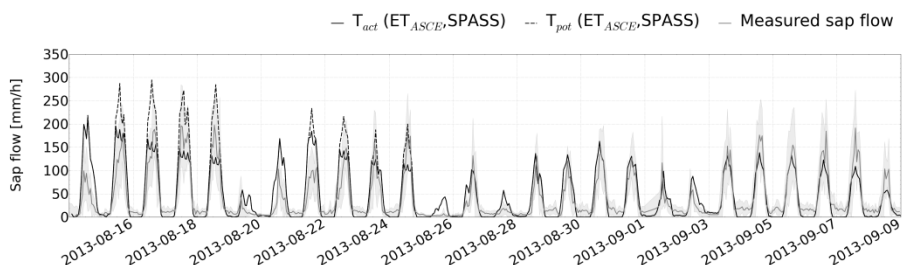

Figure 1. Time series of modelled (black) and measured (grey) sap flow rates. The measured values are averaged sap flow rates of five plants and comprise standard deviations (grey shaded). Simulations of potential (dashed) and actual (solid) sap flow is shown.

Comparing daily rates of the water balance components to measurements, transpiration simulated by SPASS agrees well with the measurements while CERES overestimates them. Evaporation is overestimated by all models due to high water contents in the top soil layers. Differences in ET_{act} simulations mainly occur due to the different chosen ET_{pot} -model, but the plant models also contribute a little. In general ET_{act} is overestimated by the models. Percolation is lower than the measurements due to too low water contents in the bottom soil layers while soil water content of the whole soil column is well simulated by all models.

Conclusions

With the help of canopy models the water balance of a lysimeter system can be reasonably simulated. However, these models oversimplify plant water transport, and thus, cannot explain all underlying mechanisms.

Acknowledgements

This work was carried out in the framework of the DFG Research Unit FOR 1695 "Agricultural Landscapes under Global Climate Change – Processes and Feedbacks on a Regional Scale". My special thanks go to Heinz Lösslein from the Meteorological Institute Munich, who provided the weather data to me, and to the Helmholtz Graduate School MICMoR, which highly supports me with my scientific and professional development.

References

- Beniston, M., D. Stephenson, O. B. Christensen et al., (2007). *Climatic Change*, 81: 71-95.
- Burgess, S. S. O., M. A. Adams, N. C. Turner et al., (2001). *Tree Physiology*, 21: 589-598.
- Folland, C. K., J. Knight, H. W. Linderholm et al., (2009). *Journal of Climate*, 22: 1082-1103.
- Palmer, T.N. and J. Räisanen (2002). *Nature*, 415: 512-514.
- Priesack, E. (2006). *Expert-N Dokumentation der Modellbibliothek – FAM-Bericht 60*, 310 pp.

Genotypic predictions and environmental characterization by coupling climate suitability and statistical models

*J. M. Herrera*¹ – *L. L. Häner*² – *Annelie Holzkämpfer*³ – *D. Pellet*²

^{1,2}Institute for Plant Production Sciences, Agroscope, Route de Duillier 50, 1260 Nyon, Switzerland, ³Institute for Sustainability Sciences, Agroscope, Reckenholzstrasse 191, 8046 Zürich, Switzerland¹e-mail: juan.herrera@agroscope.admin.ch

Introduction

Genotype performance often varies across environments as a result of Genotype by Environment interaction ($G \times E$). One challenge that stems from $G \times E$ is the characterization of environments to better understand the consequences of $G \times E$. The possibility to cluster environments with similar characteristics helps breeders and agronomists to efficiently target germplasm and utilize resources. Environments were clustered by applying a set of different clustering methods. However to our knowledge these approaches were so far not used to extrapolate findings to regions for which crop data do not exist (referred as unobserved environments hereafter).

A second challenge associated to $G \times E$ is the prediction of the genotypic value of a candidate genotype in a specific environment. Prediction is especially desirable for unobserved environments. Researchers have considered weather variables by regressing genotypes on environmental covariates and $G \times E$ were modeled using interactions between genotypes and the environmental covariates. However, such approaches have a limited applicability to predict genotypic performance on large areas from gridded weather data.

This study had three objectives: i) evaluate if a recently developed algorithm would be suitable for utilizing weather gridded data to predict genotypic performance in Switzerland, ii) identify a procedure to cluster unobserved environments and environments for which crop data is available, and iii) simplify the integration between approaches used for genotypic value prediction and those used for clustering environments.

Materials and Methods

We derived environmental limiting factors from daily weather data using a recently developed wheat suitability approach (Holzkämpfer et al., 2015) that allows determining grain yield limitations as a function of growth stage. The limiting factors were then related to genotypic performance in variety trials. Prediction accuracy was evaluated by correlations between predicted and observed values for seven winter wheat genotypes grown at 10 sites during three years. We obtained clusters for the sites based only on the information provided by the limiting factors with a self-organizing map (SOM) algorithm (Boelaert et al., 2014). To determine whether the mega-environments defined by SOM were suitable and reliable, we compared the results with those from a hierarchical cluster based on the grain yield of the wheat genotypes according to Pearson's correlation within clusters.

Results and Discussion

Figure 1 shows the relationship between observed grain yield and predicted genotypic values using the proposed algorithm. The results demonstrate a satisfactory level of accuracy ($r=0.63$) for grain yield predictions based on the environmental limiting factors. The accuracy varied for the studied genotypes. However it was acceptable for all of them and ranged from 0.66 (var. 83) to 0.92 (var. 21). Although the accuracy depends also on the dataset, our results were similar or higher than those reported in recent studies; e.g. $r=0.63$ (Lopez-Cruz et al., 2015) and $r=0.30$ (Heslot et al., 2014). Compared to those reports, the approach that we followed relied on a different statistical model and allowed us to use gridded weather data to predict country-wide genotype performance.

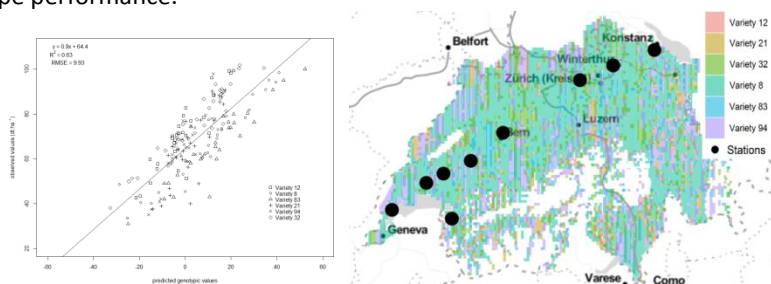

Figure 1. Predictions of yield for wheat varieties using environmental limiting factors compared to observed values and the resulting map showing the highest yielding genotypes for 10,000 sites of 4 km².

The SOM approach using only environmental limiting factors formed 13 clusters while hierarchical clustering based on grain yield grouped the environments into 15 clusters (data not shown). Although there were environments that were grouped together with one approach and remained separated with the other, the suitability and reliability of using limiting factors as the sole source of information to characterize environments was similar to that using grain yield. Average correlations within groups with hierarchical clustering according to grain yield was 0.55 while it was 0.52 using the limiting factors and SOM.

Conclusions

The integration of functionally defined environmental limiting factors with an algorithm proved to be a suitable approach for predicting genotypic performance from gridded weather data. Switzerland is a challenging study case since landscape complexity is high. In addition, the environmental limiting factors allowed matching sites according to environmental profiles through a SOM algorithm and as a result consider unobserved environments in relation to environments where the performance of specific genotypes is better known.

References

- Boelaert, J., L. Bendhaiba, M. Olteanu et al., (2014). In: T. Villmann, F.-M. Schleif, M. Kaden et al.,: Advances in Self-Organizing Maps and Learning Vector Quantization. Springer, Heidelberg, 314 pp.
- Heslot, N., D. Akdemir, M.E. Sorrells et al., (2014). Theoretical and applied genetics, 127: 463-480.
- Holzkmper, A., D. Fossati, J. Hiltbrunner et al., (2015). Regional Environmental Change, 15: 109-122.
- Lopez-Cruz, M., J. Crossa, D. Bonnett et al., (2015). G3: Genes|Genomes|Genetics, 5: 569-582.

Sensitivity analysis of the DAISY model applied to winter wheat - summer maize rotation in the North China Plain

M. Jabloun^{1,2} – *L. Xiaoxin*⁴ – *J. E. Olesen*^{1,2} – *K. Schelde*¹ – *X. Zhang*⁴ – *F. Tao*³ – *C. Hu*⁴

¹ Dept. of Agroecology, Aarhus University, e-mail: Mohamed.jabloun@agro.au.dk

² Sino-Danish Centre for Education and Research (SDC), Niels Jensens Vej 2, 8000 Aarhus C, Denmark

³ Institute of Geographical Sciences and Natural Resources Research, Chinese Academy of Sciences, Beijing, 100101, China

⁴ Key Laboratory of Agricultural Water Resources, the Center for Agricultural Resources Research, Institute of Genetics and Developmental Biology, Chinese Academy of Sciences, Shijiazhuang 050021, China

Introduction

Generally, finding an accurate estimate for all the parameters for which models best fit experimental data is a complex and computationally expensive process specifically for complex simulation models (Whittaker et al., 2010). Therefore, rigorous analysis of parameter sensitivity and reduction of the parameter space are essential to facilitate the calibration process. Despite an increasing awareness of the importance of sensitivity analysis (SA) in model implementation and parameterisation, particularly in identifying influential parameters before the calibration process, screening SA methods have not yet, to the best of our knowledge, been applied to the DAISY model. Therefore, the aim of this study is to analyse the sensitivity of key outputs of DAISY to crop and soil parameters and the extent to which parameter sensitivities are affected by crop and soil management and by environmental conditions.

Materials and Methods

The analysis was performed using long-term experimental data of a winter wheat-summer maize double cropping system in North China Plain (NCP). Data from nine consecutive years (1997 to 2006) from a completely randomized block design with four N fertilizer rates (200, 400, 600, and 800 kg urea-N ha⁻¹ year⁻¹) were used. The first three years (1997-2000) were used as a warm-up period. SA was performed using the Morris screening method (Morris, 1991) to identify the most influential crop and soil parameters for four key model outputs grain yield (Mg ha⁻¹), grain N content at harvest (kg N ha⁻¹), cumulated evapotranspiration (mm) and N leaching (kg N ha⁻¹).

The sensitivity of 39 crop parameters which for the two crops sum to 78 parameters and 29 soil parameters which for the three soil layers sum to 46 parameters was investigated. Due to a lack of information about the prior probability distributions for each parameter, we assumed an independent uniform distribution for each parameter with bounds set at 20% of either side of its nominal value as also used by (Sourisseau et al., 2008). The output sensitivity to crop and soil input parameters was determined for different years with diverse weather conditions and under different N fertiliser rates.

Results and Discussion

Generally, the results of the Morris analysis of the different output variables suggest that parameters with higher overall impacts on model outputs had higher nonlinear effect and/or interacted with other parameters. It was found that, among 85 parameters, only 34 and 36 parameters were identified as being influential for the different model variables during 2003-04 (wet) and 2004-05 (dry) season, respectively. The same result was found for both crops. It is noteworthy that the same set of sensitive parameters but with different ranks were found for both crops when all model outputs were considered. Nevertheless, when model outputs were analysed separately, the sensitive parameters were substantially different. Therefore, it is interesting to notice that some parameters, specifically soil related parameters, are shown to be significantly more sensitive when evaluated in water-limited conditions, especially for yield and grain N. Thus the sensitive (and insensitive) parameters cannot be assumed to be consistent across years which corroborate the findings of van Werkhoven et al., (2008). These findings were also confirmed for the different N treatments investigated in our study. However, the effect of N fertilization rates on model parameter sensitivity ranks was negligible. Furthermore, our findings suggest that multiple influential parameters may affect several output variables and that the influential parameters varied between crops and years. Interestingly, the results of the SA highlighted the importance of the previous crop in affecting the output variables of the next crop. In fact, the cumulated N leaching over the maize cropping season was also affected by parameters relating to crop phenology and to crop photosynthesis of winter wheat grown prior to growing maize. Similarly, N leaching under winter wheat was also affected by parameters for the maize crop. These findings will have direct implications on model calibration strategy.

Conclusions

We demonstrated that the ranking of the influential parameters depended on weather conditions and model output variable considered. Interestingly, parameterisation of the previous crop had a substantial effect on N leaching of the current crop and also affected crop yield and grain N content of the current crop, depending on the wetness or dryness of the cropping season.

Acknowledgements

This study was financially supported by Aarhus University and by the Sino-Danish University Centre for Education and Research. It was further linked to the CRES Centre funded by the Danish Council for Strategic Research under contract no: DSF-EnMi 09-066868.

References

- Morris, M.D. (1991). *Technometrics* 33: 161–174.
- Sourisseau, S., Bassères, A., Périé, F., Caquet, T. (2008). *Water research* 42: 1167–1181.
- Van Werkhoven, K., Wagener, T., Reed, P., Tang, Y. (2008). *Water Resources Research* 44: W01429.
- Whittaker, G., Confesor Jr, R., Di Luzio, M., Arnold, J.. (2010). *Transactions of the ASABE*, 53: 1487–1499.

Linking satellite imagery and crop modeling for integrated assessment of climate change impacts on chickpea yields in Southern India

D. M. Kadiyala^{*} – *G. Murali* – *S. Nedumaran* – *D. Kumara Charyulu* – *A. Whitbread* – *M. C. S. Bantilan*

International Crops Research institute for Semi-Arid Tropics, Patancheru, Hyderabad, India -502324

* Corresponding author, email: d.kadiyala@cgiar.org

Introduction

Chickpea (*Cicer arietinum* L.) is the largest pulse crop grown in India and the second most widely cultivated food legume in the world. Chickpea is a cool season grain legume that is particularly sensitive to the effects of high temperatures at reproductive stage which usually result in severe yield reductions (Wang et al., 2006). Heat stress at reproductive stage is becoming a major constraint to chickpea production because of large shift in chickpea area from the cooler, long season environments to warm, short-season environments (Gaur et al., 2014). Given the importance of chickpea as a major pulse crop, it is necessary to study and understand the impacts of future climate changes on chickpea productivity in the major chickpea growing regions. Mapping spatial distribution of chickpea using remote sensing imagery and linking with crop models using Geographical Information System (GIS) assists in the understanding of climate change impacts at a regional scale.

Materials and Methods

Land use land cover classification was performed using LANDSAT-8 and MODIS 250 m temporal data with spectral matching techniques. The chickpea growing regions in the state were concentrated in the four districts and 810 sample locations were surveyed for information about the management practices followed by farmers. This management data was used as an input to DSSAT model to simulate current future yields with and without adaptation options. In order to create a representative 30-year weather series for each location, we utilized neighboring sites from the highly spatially resolved WorldClim data, which is available historically as monthly values. The GCM's used include GFDL-ESM2G and MICROC5. The sequence analysis tool of DSSAT v4.5 was used to simulate fallow-chickpea rotation in the study regions using the test cultivar JG-11.

Results and Discussion

Base yield (1980-2009) in study location was spatially heterogeneous ranging between 150 to 2795 kg/ha. The results suggest that as compared to baseline climate, the climate change by 2069 (Mid –century period) may decrease the yield of chickpea by 4.3 to 18.6% across various locations tested. Yield benefits with various adaptation options revealed that application of one critical irrigation at 60 DAS found to be beneficial in increasing chickpea yields under climate change. Although projected

annual rainfall is predicted to increase for many of the regions where chickpea will be grown, the reduction in yield under climate change in fallow-chickpea crop rotation is attributed to the predicted rises in temperature

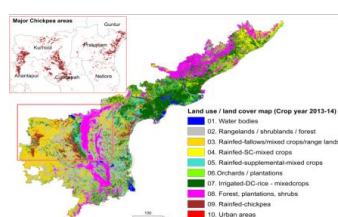

Figure 1. Land use land cover map of study area

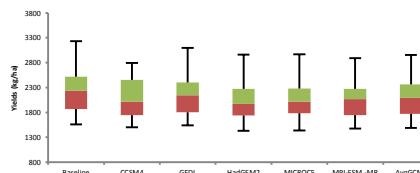

Figure 2. Box plots of chickpea yields during mid-century period under RCP.8.5 with one irrigation

Conclusions

The results suggested that climate change impacts on chickpea differ regionally and needs location specific adaptation options or strategies rather. These simulations indicate that providing one supplemental irrigation or advancing the sowing window appeared to mitigate the negative impacts of climate change.

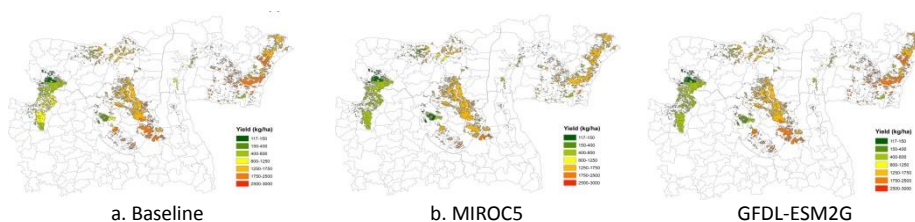

Figure 3. Spatial distribution of chickpea yields as projected by two GCMs compared to baseline

Acknowledgements

This work was undertaken as part of the CGIAR Research Program on Policies, Institutions, and Markets (PIM) led by the International Food Policy Research Institute (IFPRI). Funding support for this study was provided by the Global Futures Project funded by the Bill and Melinda Gates Foundation; the CGIAR Research Program on Climate Change, Agricultural and Food Security (CCAFS); CGIAR Research Program on Grain Legumes (GL) and CGIAR Research Program on Policies, Institutions, and Markets

References

- Wang, J., Y.T.F. Gan, F. Clarke, C.L. McDonald (2006). Response of chickpea yields to high temperature stress during reproductive development. *Crop Science*, 46: 2171–2178.
- Gaur, P. M., A.K. Jukanti, S. Samineni, S.K. Chaturvedi, P.S. Basu, A. Babbar, et al., (2013). Climate change and heat stress tolerance in chickpea. In: *Climate Change and Plant Abiotic Stress Tolerance*. Wiley-VCH Verlag GmbH and Co, Weinheim, Germany, 839-855.

Estimation of sugar beet yield and its partitioning under different applied water and nitrogen

H. Kamal¹ – S. Zand-Parsa² – M. Zare³

¹ Department of Irrigation, PhD student, Shiraz University, Shiraz, Iran, hamidreza14kamali@yahoo.com

² Department of Irrigation, Associate professor, Shiraz University

³ Department of irrigation, M.S. student, Shiraz University

Introduction

Pattern of allocating dry matter to crop components has always been regarded as one of the most important challenges in crop modeling, as it plays an important part in estimation of yield. In present study a logistic model was developed for estimating total dry matter production and then dry matter partitioning was estimated by four models that three of them were presented by Webb *et al.*, (1997) and Werker *et al.*, (1999) and the last one is developed in present study.

Materials and Methods

Experimental design in the first year (2013) was line source with irrigation treatment as the main plot and nitrogen fertilizer as the subplot. Irrigation treatments were 120, 100, 75, 75 and 50 percent of full irrigation. Nitrogen was applied at 0, 60, 120 and 180 kg N ha⁻¹ as urea. In second season (2014), experimental design was a split plot arrangement in randomized complete block design with irrigation treatment as the main plot and N fertilizer as the subplot with three replications. Irrigation treatments were 120 (I₁), 100, 75, 75 and 50 percent of full irrigation and the experimental plots were irrigated by furrow irrigation method. Nitrogen treatments in second season included: 0, 60, 120, 180 and 240 kg N ha⁻¹ as urea.

Results and Discussion

Data of second year was used for calibration and first year was used for validation. Calibration and validation of the logistic model, that was used for estimating total dry matter, is shown in Fig. 1. In the model that was constructed by Webb *et al.*, (1997), the amount of applied water was not got involved in dry matter partitioning and α was fixed and β illustrated soil nitrogen content, but in this study α and β was related to both nitrogen and water in no dimensional form as is shown in Eq. 1.

$$Q_s = P^2, Q_k = (1 - P), Q_r = P(1 - P), P = \alpha + \frac{\beta}{1 + e^{\sigma(\epsilon - \mu)}} \\ \alpha = 0.4438 - 0.1403(IR/IR_0) + 0.038(N/N_0), \beta = 0.3814 + 0.9832(IR/IR_0) + 0.2585(N/N_0) \quad (1)$$

where Q_s , Q_k and Q_r are partitioning of assimilates to the shoot, storage root and fibrous root respectively. IR is amount of applied water, IR_0 is amount of required water for full irrigation treatment, N is amount of nitrogen that is available for crop and N_0 is amount of recommended nitrogen.

The second model was extracted from the allometric growth function that was describe by Werker *et al.*, (1999). In these model R represents root dry matter, S is

shoot dry matter, α_r and α_s are initial partitioning fraction of total dry matter to root and shoot respectively.

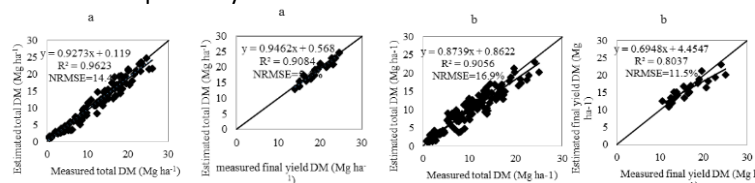

Figure 1. Calibration(a) and validation(b) of the logistic model in estimation of total dry matter and final yield dry matter

$$R = R_0 \left(\frac{W}{W_0}\right)^{\alpha_r \frac{W_0}{R_0}}, S = S_0 \left(\frac{W}{W_0}\right)^{\alpha_s \frac{W_0}{S_0}}$$

$$\alpha_r = 0.3279 - 0.0136 \left(\frac{IR}{IR_0}\right) - 0.0226 \left(\frac{N}{N_0}\right),$$

$$\alpha_s = 0.1935 + 0.0624 \left(\frac{IR}{IR_0}\right) + 0.0803 \left(\frac{N}{N_0}\right) \quad (2)$$

The third model was derived from the model that was described by Werker *et al.*, (1999). In this model, K indicate the effects of drought and nitrogen on dry matter partitioning between root and shoot respectively.

$$R = W - \frac{1}{K} \log(1 + KW), S = \frac{1}{K} \log(1 + KW)$$

$$K = 0.1733 + 0.2387 \left(\frac{IR}{IR_0}\right) - 0.1835 \left(\frac{N}{N_0}\right) \quad (3)$$

Finally, the logistic model was developed in present study:

$$R = \frac{R_m}{(1 + \exp(-bt))}, G = W - R$$

$$R_m = 0.811 + 0.082 \left(\frac{IR}{IR_0}\right) - 0.036 \left(\frac{N}{N_0}\right),$$

$$a = -5.989 + 10.718 \left(\frac{IR}{IR_0}\right) + 5.199 \left(\frac{N}{N_0}\right),$$

$$b = 0.0123 + 0.0188 \left(\frac{IR}{IR_0}\right) + 0.0075 \left(\frac{N}{N_0}\right), \quad (4)$$

In present study, we consider both amount of soil and applied fertilizer nitrogen:

$$N = N_s + N_f, N_0 = N_s + N_{f0} \quad (5)$$

where N_s is initial soil nitrogen (kg ha⁻¹), N_f is amount of nitrogen applied (kg ha⁻¹) and N_{f0} is recommended amount of fertilizer nitrogen applied to the crop (kg ha⁻¹).

Table 1. Validation of dry matter partitioning models

Model Number	Shoot DM		Root DM		final root yield DM	
	R ²	NRMSE(%)	R ²	NRMSE(%)	R ²	NRMSE(%)
1	0.76	24.1	0.93	18.5	0.91	9.3
2	0.57	63.5	0.88	31.1	0.86	13.7
3	0.66	30.7	0.89	18.9	0.91	9.5
4	0.82	23.1	0.93	18.9	0.90	8.5

Conclusions

Results showed that estimating total dry matter by the logistic model was proper. On the other hand, between four model that was validated for dry matter partitioning, the first and fourth one had better results in shoot, root and final root yield dry matter estimation.

References

- Webb, C. R., Werker, A. R. and Gilligan, C. A. (1997). Modelling the dynamical components of the sugar beet crop. *Annals of botany* 80: 427-436.
- Werker, A. R., Jaggard, K. W. and Allison, M. F. (1999). Modelling partitioning between structure and storage in sugar beet: Effects of drought and soil nitrogen. *Plant and soil* 207: 97-106.

Modelling cover crop effects in a corn-soybean rotation in Iowa on water and nitrogen tile drain fluxes

K. C. Kersebaum¹ – R. W. Malone² – T. C. Kaspar² – L. Ma³ – D. B. Jaynes²

¹ Institute for Landscape Systems Analysis, Leibniz Centre for Agricultural Landscape Research, Eberswalder Str. 84, D-15374, Germany, ckersebaum@zalf.de

² National Laboratory for Agriculture and the Environment (NLAE), USDA-ARS, Ames, IO, USA

³ Agricultural Systems Research Unit (ASRU), USDA-ARS, Fort Collins, CO, USA

Introduction

Beside yield prediction crop models also provide a good opportunity to analyze environmental issues, such as water dynamics and nitrogen emissions, since crops are major sinks of nitrogen in soil. Drained soils are especially vulnerable for nitrogen losses because dissolved nitrate is rapidly transported to surface waters by the drainage with reduced opportunities for plant uptake or denitrification to occur.

Fall-planted cover crops are a promising method to substantially reduce nitrate loss from artificially drained agricultural fields (Kaspar et al., 2012). Agricultural models can be used to evaluate management practices, including winter cover crops, under a wide range of pedoclimatic conditions. To simulate nitrogen loss in subsurface drainage in the U.S. Midwest, we integrated a simple drain flow component into the agroecosystem model HERMES and compared predictions to four years of data (2002-2005) from Iowa fields in corn-soybean with (CC) and without winter rye cover crop (NCC).

Materials and Methods

The Boone County Iowa field experiment was used to test HERMES for response to winter rye (*Secale cereale*) cover crop. Predominant soils are fine-loamy textured mesic Typic Endoaquolls and mesic Aquic Hapludolls. Eight 30.5 x 42.7 m plots were included in the experiment. Four plots included rye as the winter cover crop and four were a control treatment without winter rye. Corn (*Zea mays*) was planted in late April to mid-May of even years and soybean (*Glycine max*) planted in early to mid-May of odd years from 2000-2005. Split applications of fertilizer were spring applied in corn years at annual rates of 224 to 237 kg N ha⁻¹. A 7.6 cm diameter corrugated drainage pipe was installed 1.2 m below the soil surface in the center of each plot. Flow rates in the pipes were measured and composite samples from each plot collected for analysis of flow-weighted nitrate-N concentration on a weekly or shorter basis. Soybean and corn yield were determined and grain samples were collected at harvest for protein and total N content. Above ground winter rye shoot dry matter was collected before spring termination and analyzed for N content. HERMES was calibrated for NCC and tested using CC. The revised model had a simple drainage component implemented. The model simulation was started in 1992 to allow hydrology and C/N dynamics to initialize prior to model calibration and testing using data from 2002 to 2005.

Results and Discussion

Overall HERMES reasonably simulated annual N loss in NCC and CC and the annual differences between the two treatments. The average annual observed and simulated N loss was 43.8 and 44.4 kg N ha⁻¹ (NCC) and 17.6 and 20.0 kg N ha⁻¹ (CC), with an overall model efficiency EF including both treatments of 0.72. The cumulative monthly N loss over the four year period was also simulated well (fig. 1; EF >0.9 for each treatment), with NCC over predicted by 2% and CC over predicted by 14%. HERMES slightly under predicted the average annual effect of winter rye reducing N loss in drainage with observed and simulated NCC-CC differences of 26.2 and 24.4 kg N ha⁻¹, since average annual rye shoot N was under predicted by 3.2 kg N/ha or 6.7%. Average annual corn yield was over predicted by 0.1 Mg/ha. Soybean yield was under predicted by 0.1 Mg/ha in 2005 but was over predicted by 1.3 Mg/ha in 2003.

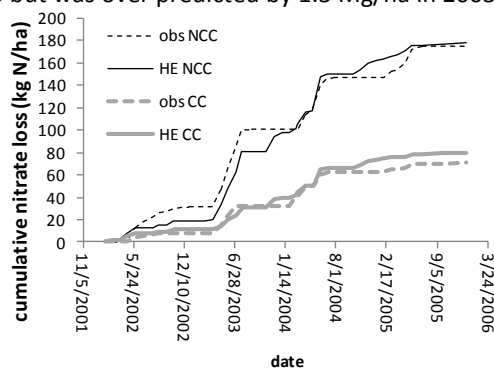

Figure 1. Simulated/observed cumulative monthly N loss in drain flow. CC is with and NCC without cover crop

Conclusions

Although simulated monthly drain flow volume showed some deviations, cumulative monthly and annual water and N drain flow were reasonable compared to field data and comparable to other published drainage model tests (Malone et al 2014). The results suggest that HERMES is a promising tool to estimate annual N loss in drain flow in the U.S. Midwest under corn-soybean rotations with winter rye as a cover crop.

Acknowledgements

R. W. Malone acknowledges the receipt of a fellowship from the OECD Co-operative Research Programme: Biological Resource Management for Sustainable Agricultural Systems in 2015. K.C. Kersebaum was supported by FACCE JPI MACSUR (2812ERA 147). Data were provided from USDA-ARS.

References

- Kaspar, T.C., D.B. Jaynes, T.B. Parkin, T.B. Moorman, and J.W. Singer. (2012). Effectiveness of oat and rye cover crops in reducing nitrate losses in drainage water. *Agricultural Water Management* 110:25-33.
- Malone, R.W., D.B. Jaynes, T.C. Kaspar, K.R. Thorp, E. Kladvko, L. Ma, D.E. James, J. Singer, X.K. Morin, and T. Searchinger. (2014). Cover crops in the upper midwestern United States: Simulated effect on nitrate leaching with artificial drainage. *Journal of Soil and Water Conservation* 69(4):292-305

Intercropping oil palm: a tree-soil-crop interactions model

N. Khasanah^{1,2} – *M. van Noordwijk*^{1,2} – *K. Hairiah*³

¹ World Agroforestry Centre (ICRAF), Southeast Asia Regional Programme, Bogor, Indonesia

² Plant Production Systems, Department of Plant Sciences, Wageningen University, Wageningen, the Netherlands

³ Department of Soil Science, Brawijaya University, Malang, Indonesia

Introduction

Global demand for palm oil may double by 2020, and triple by 2050 (Prokurat, 2013). Conversion of lowland tropical forests in areas of suitable climate is a major concern (Koh and Wilcove, 2008; Koh et al., 2011). Oil palm is part of mixed agroforestry in its African centre of origin, but all current expansion is based on a monoculture technology. In sub-optimal oil palm climates, however, interest in mixed production systems is increasing. We developed a module representing the physiology and phenology of oil palm flower and fruit development in Water, Nutrient and Light Capture in Agroforestry System (WaNuLCAS) model (van Noordwijk and Lusiana, 1999; van Noordwijk et al., 2011) to explore mixed system. The model represents a four-layer soil profile with four-spatial zone where trees and/or crops can be planted and has a daily time step. It accounts for light, water, and nutrient (N and P) as growth resources, subject to competition and sharing. Interactions are based on above- and below-ground architecture, physiology and phenology. The oil palm module includes five elements: time keeping of frond emergence (phyllochron time steps), sex determination of flowers, fruit abortion, book keeping of fruit stage development, and a possible harvest cycle of a fruit bunch at the end of each phyllochron. Three factors: water availability, nutrient availability, and growth reserves determine the dynamics of phyllochron time, flower determination and fruit development. The model, therefore, can be used to explore growth and production of oil palm in either monoculture or mixed system with other crops or trees across climate, soil, and management conditions.

Materials and Methods

We used the WaNuLCAS model to explore growth and production of monoculture oil palm, monoculture cacao, and mixed oil palm-cacao, in a factorial design of water hydraulic redistribution by deeper root (without and with), long dry period (3 months: without and with), and annual rainfall (2200, 1100, 550 mm yr⁻¹). Planting distance was 8.5 m × 8.5 m (138 palm ha⁻¹) for oil palm monoculture, 4 m × 4 m (833 tree ha⁻¹) for cacao monoculture, and 8.5 m × 8.5 m (138 palm or tree ha⁻¹) for both cacao and oil palm in mixed oil palm-cacao.

Results and Discussion

In simulations with a long dry period and effects of hydraulic lift, bunch weight of oil palm in mixed system was predicted to be higher than in monoculture, however, only at the early production stage (Figure 1A). The lower production in subsequent years is due to smaller bunch size. Hydraulic lift can reduce the effect of long dry periods on male flower induction (Figure 1B).

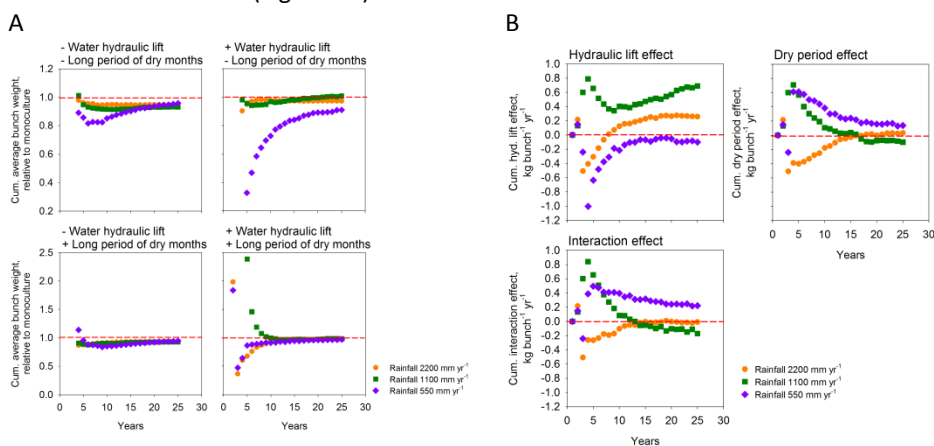

Figure 1. Cumulative average bunch weight of oil palm in mixed system (relative to oil palm monoculture) at different conditions (A) and cumulative effect of each condition (B)

Conclusions

- In conditions with long dry period and with hydraulic lift, bunch weight of oil palm in mixed system is predicted to be higher than in monoculture system.
- In other words, hydraulic lift stimulates production of female inflorescence; however, it only happened during the early production stages.
- The physiology of flowering in response to water availability and growth reserve, therefore, needs further fine-tuning; process-level understanding can be used to predict complex intercropping effects and options for agroforestry in sub optimal oil palm climates.

References

- Koh, L.,P., Miettinen, J., Liew, S., C., Ghazoul, J., (2011). Remotely sensed evidence of tropical peatland conversion to oil palm. PNAS vol. 108 no. 12: 5127–5132.
- Koh, L.,P., Wilcove, D., S. (2008). Is oil palm agriculture really destroying tropical biodiversity?. Conservation Letters: 60–64.
- Prokurat, S., (2013). Palm oil - strategic source of renewable energy in Indonesia and Malaysia. JoMS: ss. 425-443.
- van Noordwijk, M., Lusiana, B., Khasanah, N. and Mulia, R. (2011) WaNuLCAS version 4.0. Background on a model of water, nutrient and light capture in agroforestry systems. ICRAF, Bogor, Indonesia.
- van Noordwijk, M., Lusiana, B. (1999) WaNuLCAS a model of water, nutrient and light capture in agroforestry systems. Agroforestry System 43:217–242.

Reengineering of the CERES-Rice model for facilitation of parallel crop yield simulation using the cordex data

K. S. Kim^{1,2} – *S. W. Hyun*¹ – *B. H. Yoo*¹

¹ Department of Plant Science, Seoul National University, Seoul, Korea, e-mail: luxkwang@snu.ac.kr

² Interdisciplinary Program in Agricultural and Forest Meteorology, Seoul National University, Seoul, Korea

Introduction

Crop yield simulations have been used for global and regional assessment of climate change impact on crop production (Rosenzweig et al., 2014). Gridded approaches for crop yield simulations are often based on crop growth models designed to simulate crop yield at a specific site. Such crop models are usually written in Fortran, which could make it difficult to perform adaptive maintenance. For example, Ewer et al., (1995) suggested that implementation of new functionalities could be hampered by legacy research codes in Fortran. Instead of modifying crop growth model in Fortran to implement adaptive features, a re-engineering approach could be used to minimize problems associated with maintenance and improvement of legacy systems. For example, advanced computer programming languages that support file streams and dynamic data management could be used to improve an existing crop model in order to facilitate high-performance computing for crop growth simulation. The objective of this study was to re-engineer the legacy Fortran code of a crop growth model in order to apply message processing interface (MPI) for effective gridded simulation of crop yield and to allow the use of gridded weather data, e.g., the regional climate data.

Materials and Methods

The Decision Support System for Agrotechnology Transfer (DSSAT) model was used to apply the MPI for regional impact assessment of crop yield. The DSSAT model often depends on static variables in subroutines, which would make it difficult to perform a concurrent simulation of crop growth over a region. Using C++, the source code of the CERES-Rice model, which is a rice model within the DSSAT, was re-engineered.

The simulated results from the original and reengineered CERES-Rice model were compared to evaluate the compatibility of two versions of the model. The values of five variables including anthesis date (ADAT), maturity date (MDAT), maximum leaf area index (LAIX), canopy weight at maturity (CWAM), and cumulative evapotranspiration at maturity (ETCM), were analyzed as Throp et al., (2012) suggested. These variables represent the numerical accuracy in simulating crop physiology (ADAT and MDAT), leaf area development (LAIX and CWAM), and water balance (ETCM). Differences in variables between models were quantified using mean absolute difference (MAD) between models written in Fortran and C++.

The MPI was also implemented in the re-engineered version of the CERES-Rice model to allow parallel simulations of crop growth. For regional simulation of crop growth, subroutines associated with weather inputs were modified to use gridded climate data

as inputs to the model. In this study, Coordinated Regional Climate Downscaling Experiment (CORDEX) data in network common data form (netCDF) format was used as inputs to the CERES-Rice model written in C++. The re-engineered version of the CERES-Rice model was modified to enable to store outputs of crop growth simulation in the netCDF format in order to minimize post-processing of simulation results.

Results and Discussion

The re-engineered CERES-Rice model had similar simulation results to the original version of the model (Table 1). Simulated anthesis and maturity date were same between two versions of the CERES-Rice model. Outputs for water balance had considerably small differences, e.g., 0.0%, between two versions of models whereas variables associated with leaf area development had relatively larger differences, e.g., 0.1%.

The re-engineered CERES-Rice model succeeded in simulating gridded crop yield simulations using 69 cores over five nodes. The running time of regional crop yield simulations was mostly affected by data exchange rate between nodes. Although multithreading approach was used to expedite data transfer between nodes, data exchange was bottlenecked by Ethernet connection. This suggested that further studies would be merited to optimize state variable of the CERES-Rice model, which would limit the amount of data exchange between nodes.

Table 1. Mean absolute differences between the CERES-Rice models implemented using Fortran and C++ depending on simulated phenology

	MAD	%		MAD	%
N=39			LAIX	2.380E-3	0.0975
ADAT	0	0	CWAM	1.064E1	0.0886
MDAT	0	0	ETCM	2.564E-2	0.0034

Conclusions

The re-engineered version of the CERES-Rice model using C++ had similar simulation results to the original version of the CERES-Rice model. The re-engineered CERES-Rice model also allowed gridded simulation of crop simulation using the CORDEX data as inputs to the model. These results suggested that regional impact of climate change on crop production would be facilitated using the new version of the CERES-Rice model.

Acknowledgements

This work was supported by a grant from the Rural Development Administration (ATIS number PJ0101150), Republic of Korea.

References

- Ewer, J., B. Knight, D. Cowell (1995). *Advances in Engineering Software*, 22, 153-168.
 Rosenzweig, C., J. Elliott, D. Deryng et al., (2014). *Proceedings of the National Academy of Sciences* 111:3268-3273.
 Thorp, K.R., J.W. White, C.H. Porter et al., (2012). *Computers and Electronics in Agriculture* 81:62-71.

Modelling changes in soil carbon stocks in New Zealand grazed pastures in response to variations in management and environmental factors

M. U.F. Kirschbaum¹

¹ Landcare Research, Palmerston North, New Zealand, KirschbaumM@LandcareResearch.co.nz

Introduction

In order to reduce net greenhouse gas emissions from pastures, it is important to identify any management options that can lead to soil organic carbon (OC) sequestration. This addressed here by using CenW 4.1, a process-based ecosystem model, to describes the biophysical drivers of the system and their interactions. The challenge lies in understanding the complex array of interacting factors that together determine the trajectory of future soil C. External factors may change:

- 1) the rate of C gain of the system, principally through net primary production;
- 2) the proportion of C and N harvested and becoming unavailable for OC formation;
- 3) the proportion of C remaining on the surface which is easily respired;
- 4) the rate of OC decomposition that determines the rate at which OC is lost.

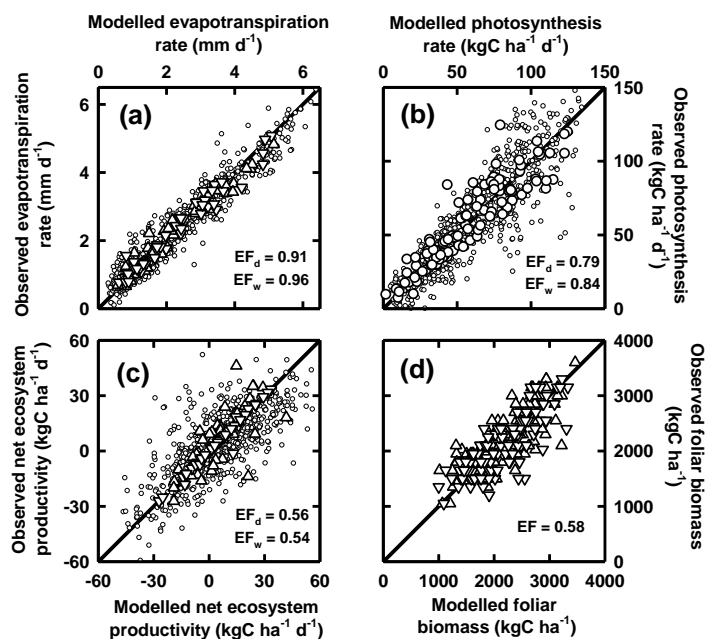

Figure 1. Observed versus modelled rates of evapotranspiration (a), photosynthesis (b), net ecosystem productivity (c) and foliar biomass (d). Small symbols show daily and larger symbols weekly data. "EF" refers to model efficiency, and the subscripts 'd' and 'w' refer to daily and weekly data, respectively.

Materials and Methods

CenW (Carbon, Energy, Nutrients, Water) is a daily time step process based model, combining the major C, energy, N and water fluxes in an ecosystem (Kirschbaum, 1999; Kirschbaum et al., 2015). All cycles are fully integrated, which allows the testing of any interactions between them. Major processes are photosynthesis, and C losses through autotrophic respiration, heterotrophic soil respiration, and respiration by grazing animals, which is a key component of the overall site C balance. The model was parameterised and tested for an intensively studied dairy farm located near Hamilton in New Zealand’s Waikato region (Kirschbaum et al., 2015). We then used the model to study changes in OC in response to changes in key input variables.

Results and Discussion

Agreement between the model and observations was excellent (Fig. 1), especially for evapotranspiration and net photosynthesis, for which 91% and 79% of observed daily variations could be explained. Agreement was less good for respiratory carbon losses. Much of that related to the capture of grazing events that were highly episodic and could release carbon at rates that were an order of magnitude greater than combined plant and soil respiration rates. Consequently, the simulation of combined carbon fluxes was not as good as the simulation of carbon gain alone with model efficiencies of 0.54 and 0.56 for weekly and daily values, respectively (Fig. 1c).

CenW was then used to explore the effect of changes in key driving variables. It resulted in a diverse picture (Fig. 2), with overall responses that could be dominated by direct effects on primary production (e.g. for fertiliser additions), through changes in the proportion of carbon retained on-site (e.g. for [CO₂]), through the effect on within-site allocation patterns (e.g. root:shoot ratios), or through a stimulation of OC decomposition rates (e.g. temperature). Overall responses to any changes in external or system properties depend on all direct and indirect effects acting together.

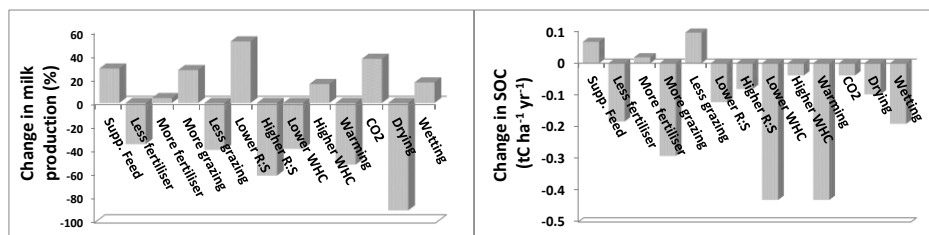

Figure 2. Summary of modelled responses in milk production and soil organic carbon (SOC) to changes in management, plant physiological factors and external environmental drivers.

References

Kirschbaum, M.U.F., Rutledge, S., Kuyper, I.A. et al., (2015). Science of the Total Environment, 512-513: 273–286.
 Kirschbaum, M.U.F. (1999). Ecological Modelling, 118: 17-59.

Modeling energy fluxes in heterogeneous cropland employing a mosaic approach

C. Klein – C. Thieme – C. Biernath – F. Heinlein – E. Priesack

Modeling Soil-Plant-Atmosphere Systems, Institute of Biochemical Plant Pathology, Helmholtz Zentrum München - Deutsches Forschungszentrum für Gesundheit und Umwelt (GmbH), Ingolstädter Landstraße 1, christian.klein@helmholtz-muenchen.de

Introduction

Recent studies show that uncertainties in regional and global climate and weather simulations are partly due to inadequate descriptions of the energy flux exchanges between the land surface and the atmosphere [Stainforth et al., 2005]. One major shortcoming is the limitation of the grid-cell resolution, which is recommended to be about at least 3x3 km² in most models due to limitations in the model physics. To represent each individual grid cell most models select one dominant soil type and one dominant land use type. This resolution, however, is often too coarse in regions where the spatial heterogeneity of soil and land use types are high, e.g. in Central Europe. The relevance of vegetation (e.g. crops), ground cover, and soil properties to the moisture and energy exchanges between the land surface and the atmosphere is well known (McPherson 2007), but the impact of vegetation growth dynamics on energy fluxes is only partly understood (Gayler et al., 2014).

Materials and Methods

An elegant method to avoid the shortcoming of grid cell resolution is the so called mosaic approach. This approach is part of the recently developed ecosystem model framework Expert-N (Biernath et al., 2013) .

The aim of this study was to analyze the impact of the characteristics of two managed fields, planted with winter wheat and potato, on the near surface soil moistures and on the near surface energy flux exchanges of the soil-plant-atmosphere interface. The simulated energy fluxes were compared with eddy flux tower measurements between the respective fields at the research farm Scheyern, North-West of Munich, Germany.

To perform these simulations, we coupled the ecosystem model Expert-N to an analytical footprint model (Mauder and Foken 2011) . The coupled model system has the ability to calculate the mixing ratio of the surface energy fluxes at a given point within one grid cell (in this case at the flux tower between the two fields).

The approach accounts for the temporarily and spatially changing contributions of the patchwork of environmental land surface conditions (land use, management, soil properties) which influence the energy flux tower measurements due to the footprint dynamics.

Results and Discussion

Our preliminary simulation results show that a mosaic approach can improve modeling and analyzing energy fluxes when the land surface is heterogeneous. In this case our applied method is a promising approach to extend weather and climate models on the regional scale.

Conclusions

A mixed approach for surface fluxes simulations can improve the understanding of the measured surface fluxes of crop fields located in a small distance to the flux tower. Simulated surface fluxes using the mixed approach are not always better representing the measurements than single crop simulations, but the simulation results are more stable and more reliably than taking only one vegetation and soil model configuration.

Acknowledgements

C.B. was funded by the Helmholtz project "REKLIM - Regional Climate Change: Causes and Effects" Topic 5: "Chemistry-climate interactions on global to regional scales."

C.K. was funded by the HGF Alliance "Remote Sensing and Earth System Dynamics".

C.T. was funded by "REKLIM - Regional Climate Change: Causes and Effects" Topic 4: "The land surface in the climate system."

References

- Biernath, C.; Bittner, S.; Klein, C.; Gayler, S.; Hentschel, R.; Hoffmann, P.; Högy, P.; Fangmeier, A. and Priesack, E. (2013), *European Journal of Agronomy* 48 : 74-87.
- Gayler, S.; Wöhling, T.; Grzeschik, M.; Ingwersen, J.; Wizemann, H.-D.; Warrach-Sagi, K.; Högy, P.; Attinger, S.; Streck, T. and Wulfmeyer, V. (2014), *Water Resour. Res.* 50 : 1337-1356.
- Mauder, M. and Foken, T., 2011, Univ., Abt. Mikrometeorologie, .
- McPherson, R. (2007), *Prog. Phys. Geog.* 31 : 261-285.
- Stainforth, D.; Aina, T.; Christensen, C.; Collins, M.; Faull, N.; Frame, D.; Kettleborough, J.; Knight, S.; Martin, A.; Murphy, J.; Piani, C.; Sexton, D.; Smith, L.; Spicer, R.; Thorpe, A. and Allen, M. (2005), *Nature* 433 : 403-406.

Disentangle mechanisms of nitrogen and water availability on soybean yields

J. Kroes^{1,*} – *P. Groenendijk*¹ – *I. Supit*² – *A. de Wit*¹ – *D. de Abellegra*³ – *S. R. Vero*³

¹ Alterra, Wageningen UR, the Netherlands

² Environmental Sciences, Wageningen University, the Netherlands

³ Instituto Nacional de Tecnología Agropecuaria, Argentina

* Corresponding author: joop.kroes@wur.nl

Introduction

Increase of agricultural production often needs to be obtained on existing arable land. This increase puts pressure on the sustainability of land management and can have considerable impact on the environment. Innovative approaches and its results, achieved within the SIGMA project (www.geoglam-sigma.info), as part of the environmental impact analyses, will be presented. This paper describes improvements we made in crop modelling using the model WOFOST and improving its resource use and management including the relation with the water and nitrogen cycle.

Materials and Methods

The environmental impacts of land degradation and land use changes on groundwater recharge and nitrate leaching is analysed for representative sites from the Joint Experiment for Crop Assessment and Monitoring (JECAM) network (www.jecam.org). Selected JECAM sites are used to combine field data, remote sensed data and dynamic models for hydrology (Van Dam et al., 2008), nitrogen leaching (Rijtema et al., 1999) and crop growth (Boogaard et al., 2013). To assess impact of nitrogen limitations on crop growth we extended WOFOST with three modules that allow a daily interaction between nitrogen in crop and soil. The first extension was a nitrogen module of the crop which is based on Lintul (Shibu et al., 2010). The second extension is a carbon module of the soil based on the model Roth-C (Coleman and Jenkinson, 1999) with different pools that use a simplified parameterization for transformation. This carbon module interacts with the third module that describes the nitrogen cycle in the soil. The nitrogen cycle distinguishes ammonium-N and nitrate-N, which allows leaching of nitrate and ammonium and uses the water flow from the hydrological sub model.

The new approach has functionalities to calculate availability of soil nitrogen for crop uptake using different management options like fertilization and crop rotations. It is applied to disentangle the mechanisms involving nitrogen and water availability by which soybean expansion and soybean monoculture impacts crop yields in the Argentinean Pampas.

Results and Discussion

The methods was tested using field data sets from The Netherlands and Argentina where soybean is grown. Results of local scale field experiments will be presented.

Environmental impact evaluations are executed of increasing agricultural productivity both on a local/regional level as well as on a global level. (Valin et al., 2013). With our approach we try to offer an integrated assessment as suggested by Webber et al., (2015). We also tried to find a proper balance between complexity of processes and simplicity of use to allow interaction with remotely sensed data. Examples of how the upscaling will be achieved are presented and discussed.

Conclusions

Complexity of processes requires integrated dynamic assessment tools in cases where insight into the processes is needed to find solutions for problems. This is often so when water and/or nitrogen are limiting and the environment is dynamic.

The combination of remote sensed data with a high spatial resolution and dynamic modelling with a high temporal resolution offers challenging research and innovative solutions.

Acknowledgements

The SIGMA project (www.geoglam-sigma.info)

References

- Boogaard, H., Wolf, J., Supit, I., Niemeier, S., and van Ittersum, M. (2013). A regional implementation of WOFOST for calculating yield gaps of autumn-sown wheat across the European Union. *Field Crops Research*, 143, 130–142. doi:10.1016/j.fcr.2012.11.005
- Coleman, K., and Jenkinson, D. S. (1999). RothC - 26.3 - A model for the turnover of carbon in soil, Model description and windows user guide.
- Rijtema, P.E., P. Groenendijk and J.G. Kroes (1999). Environmental impact of land use in rural regions. The Development, Validation and Application of Model Tools for Management and Policy Analysis. Series on Environmental Science and Management vol. 1, Imperial College Press, Imperial College, London, UK, p. 321.
- Shibu, M. E., Leffelaar, P. a., van Keulen, H., and Aggarwal, P. K. (2010). LINTUL3, a simulation model for nitrogen-limited situations: Application to rice. *European Journal of Agronomy*, 32(4), 255–271. <http://doi.org/10.1016/j.eja.2010.01.003>
- Valin, H., Havlík, P., Mosnier, A., Herrero, M., Schmid, E. and Obersteiner, M. (2013). Agricultural productivity and greenhouse gas emissions: trade-offs or synergies between mitigation and food security? *Environmental Research Letters* 8: 9pp
- Van Dam, J.C., P. Groenendijk, R.F.A. Hendriks and J.G. Kroes (2008). Advances of modeling water flow in variably saturated soils with SWAP. *Vadose Zone J.*, Vol.7, No.2, May 2008.
- Webber, H., Zhao, G., Wolf, J., Britz, W., Vries, W. De, Gaiser, T., Hoffmann, H., Ewert, F. (2015). Climate change impacts on European crop yields: Do we need to consider nitrogen limitation? *European Journal of Agronomy*, 71, 123–134. <http://doi.org/10.1016/j.eja.2015.09.002>

Analysis and modelling of spatio-temporal patterns of CO₂ and H₂O fluxes in relation to crop growth under field conditions

M. Kupisch – M. Langensiepen – A. Stadler – F. Ewert

Crop Science Group, Institute of Crop Science and Resource Conservation, Faculty of Agriculture, University of Bonn, Katzenburgweg 5, 53115 Bonn, E-Mail: mkupisch@uni-bonn.de

Introduction

Exchange of CO₂ and water vapor between plant surfaces and the atmosphere are important processes that determine plant growth and yield. They are affected by changes in physical boundary conditions and their magnitudes differ greatly between plant species. The temporal variability of gas exchange in crops has been extensively studied (Reicosky *et al.*, 1994; Wang *et al.*, 2006), but less is known about its spatial variability in fields. Understanding the spatio-temporal variability of gas exchange is necessary for modeling and estimating the dynamics of soil-vegetation-atmosphere processes at field and larger scales. Most crop modeling efforts ignore the spatial variability of gas exchange within fields which are influenced by heterogeneous soil conditions. Detailed representations of plant physiological processes at a single point within a field are typically assumed to represent the entire field. Little work has been done on scaling up from the single point to the entire field, not least due to the limited availability of experimental data. The study aimed at observing and analyzing spatial and temporal patterns of growth and CO₂ and H₂O fluxes in winter wheat and winter barley under heterogeneous soil conditions and studying the effect of input aggregation of soil heterogeneity on model outputs.

Materials and Methods

The measurements were carried out in a field near Selhausen, located in the Rur-catchment in North-Rhine-Westphalia, Germany (50.868°N, 6.451°E) during three vegetation seasons (2011–2013). The simulations comprise an application of the crop growth model GECROS (Yin and van Laar, 2005) over the whole season in dependence on spatially varying inputs. Each simulation was executed for six different spatial patterns with different edge lengths resolutions, ranging from a minimum value of 1 m to 280 m. The patterns differ only in their spatial arrangement but not with respect to their underlying frequency distributions. For the simulations with the crop model, only the amount of daily water supply was used as a spatial input parameter.

Results and Discussion

Results show that the dynamics of crop growth and carbon and water fluxes can have a high spatial and inter-annual variability depending on the underlying water supply patterns. Vegetation patterns arise from responses of growth processes and LAI

development to drought stress. Flux patterns of CO₂ could be linked to soil heterogeneity and leaf area development patterns. Simulations resulted in fluctuating responses of photosynthesis, transpiration and LAI, depending on the aggregation of input parameter step-sizes. At the level of seasonal crop growth, the output patterns of maximum LAI were decoupled from the patterns of photosynthesis and transpiration. No effects of input aggregation has been observed if the response variable was linearly dependent on the input, e. g. leaf nitrogen content. Although there is an interacting effect between environmental patterns and aggregation on flux variables, the consideration of field heterogeneity for parameterizing crop and large-scale soil-vegetation-atmosphere-transport models might not be necessary, as the differences in total simulated seasonal fluxes in dependence on aggregation size ranged between 1 and 8%.

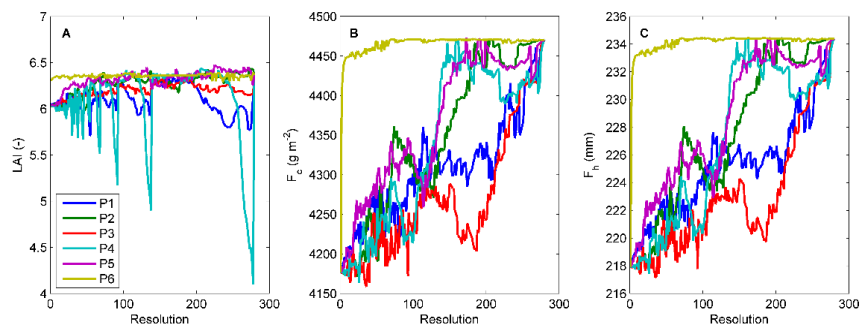

Figure 1. Mean maximum LAI (A), mean cumulative gross canopy photosynthesis (B) and transpiration (C) as calculated by GECROS model in dependence on the resolution of the underlying input patterns applied to daily water supply.

References

- Reicosky DC, Brown PW, Moran MS. (1994). Diurnal trends in wheat canopy temperature, photosynthesis, and evapotranspiration. *Remote Sensing of Environment* 49, 235–245.
- Wang J, Yu Q, Li J, Li LH, Li XG, Yu GR, Sun XM. (2006). Simulation of diurnal variations of CO₂, water and heat fluxes over winter wheat with a model coupled photosynthesis and transpiration. *Agricultural and Forest Meteorology* 137, 194–219.
- Yin X, van Laar HH. (2005). Crop systems dynamics. An ecophysiological simulation model for genotype-by-environment interactions. *Wageningen Academic Pub.*

Effect of different levels of calibration in rotation schemes simulated in five European sites in a multi-model approach

M. Lana^{a} – K. C. Kersebaum^a – C. Kollas^c – X. Yin^b – C. Nendel^a – K. Manevski^b – C. Müller^c – T. Palosuo^d – C. M. Armas-Herrera^e – N. Beaudoin^e – M. Bindl^f – M. Charfeddine^g – T. Conradt^c – J. Constantin^h – J. Eitzingerⁱ – F. Ewert^k – R. Ferrise^f – T. Gaiser^k – I. G. de Cortazar-Atauri^l – L. Giglio^g – P. Hlavinka^{m,u} – H. Hoffmann^k – M. P. Hoffmannⁿ – M. Launay^l – R. Manderscheid^o – B. Mary^e – W. Mirschel^a – M. Moriondo^s – J. E. Olesen^b – I. Öztürk^b – A. Pacholski^{j,o} – D. Ripoche-Wachter^l – P. P. Roggero^f – S. Roncossek^b – R. P. Rötter^d – F. Ruget^p – B. Sharif^b – M. Trnka^{m,u} – D. Ventrella^g – K. Waha^{c,t} – M. Wegehenkel^o – H.-J. Weigel^o – L. Wu^q*

* Corresponding author: lana@zalf.de

Introduction

Diversification of crop rotations is considered a basic agronomic practice recommended to reduce the incidence of pests, diseases, as well as to increase the resilience of agroecosystems, especially in a context of climate change and variation. The majority of crop simulation studies have focused in simulating single crops during single years. In a long term perspective, it makes more sense to simulate rotations than single crops because they can also characterize the carry-over effects of the previous crop, providing much better arguments for impact and adaptation studies. The aim of this study is to evaluate the effect of minimally versus calibrated data on the projections of crop yields using nine different crop models in five sites and different rotation schemes.

Materials and Methods

Experimental data

Data sets from five sites in Europe covering 10 crops under different crop rotation schemes were approached in this study. A comprehensive description of the sites and the crop rotation schemes can be found in Kollas et al (2015). The targeted variable was crop yield at harvest or maturity or final biomass, depending on the crop.

Crop models

Nine different crop models were used in this study. They can be initially divided in three different modes: ROTATION (when a crop model only performs continuous runs without reinitializing subroutines at the onset of the crop season - SWIM), SINGLE (when crop models only perform single crop growing seasons, not representing a true rotation scheme – DSSAT1 and DSSAT2) and ROTATION + SINGLE (when a crop model can provide results for both modes – DAISY, FASSET, HERMES, LINTUL2, MONICA, STICS).

Crop model calibration

The results observed in Kollas et al (2015) refer to crop models using a low level of calibration (defined as LOW), usually limited to information about initial values of soil

water content and soil mineral N (at a date close to sowing) for each treatment for the first year only. Additional data about key phenological observations, so as harvest dates or final biomass observations, were also provided. The high level of calibration (HIGH) contained detailed information about soil parameters, management, so as plant phenology and development.

Evaluation of crop models performance

As proposed by Bennett et al (2013), the performance of each model was evaluated by calculating complementary performance indicators. This procedure allows the quantification of error magnitude and the detection of bias. The performance indicators mean absolute error (MAE), index of agreement (IA), percent bias (PBIAS) and root mean square error (RMSE) were calculated for each site, crop, simulation mode and calibration level, and then averaged for each site.

Results and Discussion

The results of this study are structured in the following order:

- a) Evaluation of single crop model performance in simulating yields using LOW and HIGH levels of calibration for specific sites and crops;
- b) Comparison of crop multi-model ensemble using LOW and HIGH calibration levels for single crops;
- c) Comparison of the effect of LOW versus HIGH calibration on the simulation of yields in rotation schemes.

Conclusions

Initial results indicate that, for the majority of crops, the HIGH calibration does improve the model outputs for both ROTATION and SINGLE modes, when compared to the LOW calibration. The same tendency can be observed for multi-models ensemble, where HIGH calibration slightly reduced the difference between observations and simulation results. The effect of HIGH calibration is more evident in ROTATION schemes than in SINGLE, probably due the better projection of carry-over effect.

Acknowledgements

The present study was carried out in the context of CropM within the FACCE-MACSUR knowledge hub. We are thankful to all the colleagues that provided experimental and simulated data, so as advices to conduce this work.

References

- Bennett, N.D., et al., (2013). Characterizing performance of environmental models. *Environ. Model. Software* 40, 1–20.
- Kollas, C. et al, (2015). Crop rotation modelling—A European model intercomparison. *Europ. J. Agronomy* 70, 98–111.

Integrating C4 photosynthesis into the ORYZA crop simulation model for virtual assessment of C4 rice

T. Li^{} – MVR Murty – T. D. Setiyono – S. Mohanty*

International Rice Research Institute, Los Banos, Philippines

^{*} Corresponding author, t.li@irri.org

Introduction

The world needs 2.0% more rice every year to meet rice demand of the continuously increasing population. Rice, a C3 crop, is a staple food for more than half of the world's population and its conventional breeding so far has brought some success in increasing its productivity. However, new initiative is needed in order to meet rice demand in the future in the face of climate uncertainty and lack of increase in area under production. One of such initiatives is conversion of photosynthesis biochemistry in rice from that of C3 into C4 type. Plants with C4 type photosynthesis have 30% more biomass as compared to C3 plants (Wang et al., 2012), and therefore C4 rice can be a potential solution to meet future rice demand.

It is crucial to assess the potential production of C4 rice in different environments as well as the socio-economic impacts before the C4 rice variety is made available for farming. Crop simulation model is an ideal and low cost tool to conduct such work of evaluating the impact of C4 rice technology in various environments associated with appropriate agronomic practices before the technology becomes a reality.

Materials and Methods

In order to conduct virtual assessment of C4 rice, the C4 version of the ORYZA model was developed by integrating a mechanistic Farquhar leaf photosynthesis into current ORYZA model where CO₂ is considered as substrate of the light-driven photosynthesis process. Using field measurements from two nitrogen application rates (80 and 160 kg N ha⁻¹) in a lowland rice experiment conducted in 1992 to 1993, the crop parameters were calibrated for this C3 model to minimize the difference between simulated and the measured total above ground and panicle biomass. Subsequently, subroutines counting for the photosynthetic process in mesophyll cell were also integrated for C4 photosynthesis. Using the calibrated crop parameters and essential adjustment on parameters for CO₂ exchange and refixation in mesophyll cells, a verification simulation was conducted to quantify the yield advantage of C4 to C3 rice. Further simulation activity was conducted to evaluate the potential yield gains with C4 rice applied in different environments under the future climate condition in South Asia.

Results and Discussion

In the calibration of C3 rice, the simulated above-ground (WAGT) and panicle (WSO) biomass represented the measured growth dynamic with uncertainty of about 10% under full irrigation and two nitrogen fertilizer application rates (Fig. 1). The endseason WAGT and WSO of C4 rice were 50 and 40% higher than those of C3 rice with nitrogen

fertilizer of 80 kg N ha^{-1} , and 26 and 17% increases with 165 kg N ha^{-1} fertilizer, while the grain yield increased by 37 and 18%, respectively.

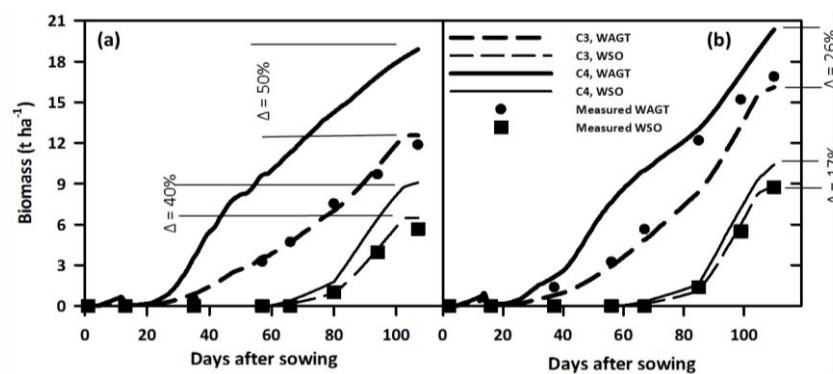

Figure 1: The measured and simulated seasonal biomass dynamics for C3 rice in comparison with simulation results of C4 rice under full irrigation with 80 and 165 kg N ha^{-1} (a and b) fertilizer rates.

In South Asia, the major rice production region in the world, C4 rice was estimated to provide 7 to 58 % yield increase in comparison to C3 rice even under the predicted $3 \text{ }^\circ\text{C}$ increase in air temperature in the next two decades (Fig. 2).

Conclusions

This study concluded that a significant yield gain of C4 rice can offset the challenge of rice demand under adverse future climate scenario. However, due to the C4 rice does not exist yet, the assessment on yield gains could be revised as long as some crop parameters such as nitrogen and water use efficiency can be verified in the future study.

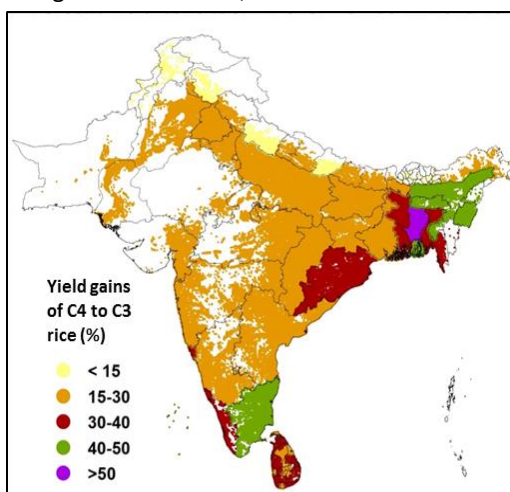

Figure 2: The grain yield increases of C4 rice in comparison with C3 rice under full water and fertilizer supply in South Asia in future climate with $3 \text{ }^\circ\text{C}$ air temperature increase.

Acknowledgements

This research was supported by Global Futures and Strategic Foresight (GFSF) project and CGIAR research Program on Policies, Institutions and Markets (PIM) led by IFPRI.

References

Wang C., L. Guo, Y. Li, Z. Wang (2012). Systematic comparison of C3 and C4 plants based on metabolic network analysis. *Systems Biology*. 6 (Suppl 2), S9.

Estimating canola yield gaps in Australia

J. Lilley – Z. Hochman – D. Gobbett – J. Kirkegaard – H. Horan – J. Navarro Garcia

CSIRO Agriculture, GPO Box 1600 Canberra, ACT 2601, Julianne.Lilley@csiro.au

Introduction

Identifying and understanding yield gaps is an important step in improving food security. Australian farmers have adopted new and improved crop management practices over the last 20 to 30 years, however there is still a gap between potential and actual yields. Canola (*Brassica napus* L.) is the third most important grain crop in Australia worth A\$2.7B in 2012/13 (AOF, 2015) and is the most widely grown broadleaf break crop for cereal-based farming systems (Angus et al., 2015). Here we describe a methodology used to calculate the water-limited yield potential (Yw) of canola across Australia's cropping zone and to determine the gap between actual farm yield (Ya) and Yw for canola. We demonstrate the inclusion of this analysis into an interactive website which enables growers, agronomists, research funders and policy makers to visualise and benchmark their own farm against local yields and yield gaps.

Materials and Methods

This canola yield gap analysis is based on the Australian analysis of yield gaps in wheat described more fully by Hochman et al., (2015). We mapped actual annual canola yields obtained by farmers (Ya) (ABS, 2012) at the statistical local area (SLA) level for each year from 1996 to 2012 for each of the 164 SLAs where canola production covered more than 1000 ha. To determine water-limited yield potential (Yw; yield that can be achieved under current best practice with well-adapted commercial varieties) we deployed APSIM Canola (ver. 7.7) (Holzworth et al., 2014) which is well validated for canola in Australia (see Robertson and Lilley 2016). Canola yields were simulated using weather data from 4,043 weather stations (Jeffrey et al., 2001) and up to three dominant soil types per weather station using the ASRIS soil map (Johnston et al., 2003). Sowing and nitrogen fertiliser rules ensured that yields were only limited by climate and water availability. Simulated yields (Yw) for each year from 1996 to 2012 were aggregated to SLA level. Thus the independently estimated annual Ya and Yw values per SLA could be compared and the yield gap (Yw-Ya) and relative yield ($Y\% = 100 \times Ya/Yw$) were calculated and mapped.

Results and Discussion

The average canola Ya in Australia from 1996 to 2012 was 1.16 t/ha, while simulation gave an average Yw of 2.23 t/ha, resulting in a yield gap of 1.07 t/ha. Thus on average, grain-growers are achieving 52% of their water limited yield potential. The large spatial and temporal variability has been mapped at SLA scale (Figure 1) and is available on the Yield Gap Australia website (www.yieldgapaustralia.com.au). The canola yield gap

analysis forms a basis for discussion of the causes of sub-optimal yields and is similar to that reported for wheat in other Australian studies (Hochman et al., 2012, 2015).

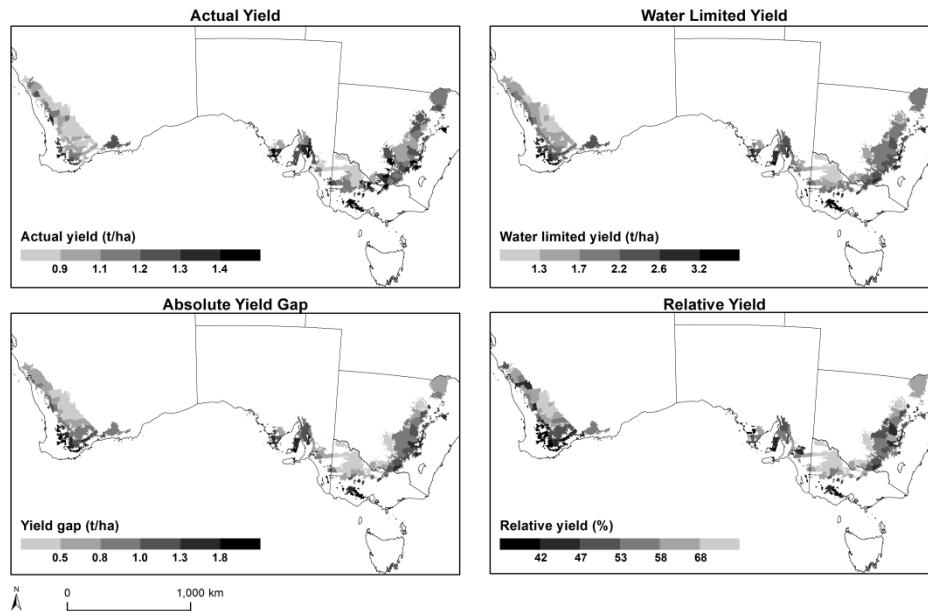

Figure 1. 17-year average dryland canola yield and yield gap in Australia (1996-2012) calculated for each SLA.

Conclusions

The Yield Gap Australia website is an interactive map-based tool for visualising the extent and geographic distribution of the gap between actual and potential production of crops in Australia and demonstrates an approach which could be readily adopted in other crops and countries. The maps provide an opportunity to investigate causes of yield gaps such as subsoil constraints, fallow weeds, time of sowing and crop nutrition.

Acknowledgements

We acknowledge the financial support of the CSIRO and the Grains Research and Development Corporation.

References

- ABS (2012). Agricultural Census: Value of Agricultural Commodities In: Australian Bureau of Statistics
- Angus, J.F., J.A. Kirkegaard, J.R. Hunt, et al., (2015) *Crop and Pasture Science*, 66: 523-552.
- AOF (2015) Australian Oilseeds Federation, www.australianoilseeds.com.
- Hochman, Z., D. Gobbett, D.P. Holzworth, et al., (2012). *Field Crops Research* 136, 85-96.
- Hochman, Z., D. Gobbett, H. Horan, et al., (2015). *Proc. 17th ASA Conference*, www.agronomy2015.com.au.
- Holzworth, D.P., N.I. Huth, P.G. deVoil, et al., (2014). *Environmental Modelling and Software* 62, 327-350.
- Jeffrey, S.J., J.O. Carter, K.B. Moodie, et al., (2001). *Environmental Modelling and Software* 16, 309-330.
- Johnston R.M., S.J. Barry, E. Bleys, et al., (2003). *Australian Journal of Soil Research* 41, 1021-1036.
- Robertson, M.J. and J.M. Lilley (2016) *Crop and Pasture Science* (in press).

Dose rising temperature reduce the winter wheat production?

L. Liu – S. Zhang – X. Qiu – J. Li – L. Tang – W. Cao – Y. Zhu

National Engineering and Technology Center for Information Agricultural, College of Agriculture, Nanjing Agricultural University, Nanjing, Jiangsu 210095, P. R. China, liuleilei@njau.edu.cn

Introduction

Agricultural production is sensitive to weather and thus directly affected by climate change. In the past 20 years, climate change impacts on crop productivity have been studied mainly by using crop simulation models (Rosenzweig et al., 2014). However, there is lack of experimental information on the effects of climate change on crop production. Here, we investigated the relationships between temperatures and growth periods, grain yields by using long term observation data across the Northern Winter Wheat Region of China (NWR). The results could help clarify whether temperature change had an impact on growth periods and grain yields of winter wheat in China.

Materials and Methods

The observed winter wheat phenology, yield and climate data were collected. In this study, only the dataset with cultivars planted more than 20 years was selected. The accumulated growing degree days (GDD, °C d) from sowing to jointing (GDD1), from jointing to anthesis (GDD2), from anthesis to maturity (GDD3), and from sowing to maturity (GDDT) was calculated according to Cao and Moss (1997). Heat degree-days (HDD, °C d) defined as the total heat degree-days when daily maximum temperature >30 °C from anthesis to maturity was calculated according to Liu et al., (2014).

Results and Discussion

At NWR, there was a positive linear relationship between the variation in average temperature and the variation in wheat yield components, except for the 1000-grain weight (Fig. 1a-c). The spikelet number in the study area increased significantly ($P < 0.05$), with the increases of 3.55×10^5 per ha for each 1 °C increase in average temperature. In addition, a significant ($P < 0.01$) linear relationship between the variation in average temperature and grain yield was also found in NWR (Fig. 1d), which indicated that the average temperature exhibited significant positive effects on grain yield. In the past decades, the grain yield of winter wheat in the study area increased by 406.3 kg ha^{-1} for each 1 °C increase in average temperature.

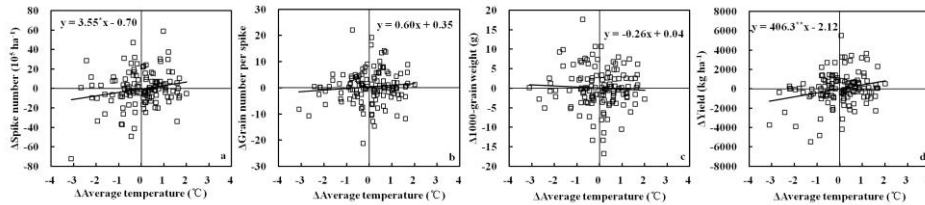

Figure 1. Relationships between year-to-year changes for growing season average temperatures (Δ Average temperature) and year-to-year changes for wheat grain yields (Δ Yield), spike number (Δ Spike number), grain number per spike (Δ Grain number per spike) and 1000-grain weight (Δ 1000-grain weight).

Previous studies suggested that short episodes of temperatures >30 °C during flowering can cause heat stress and lead to a decreased seed setting, resulting in a low grain number. In the present study, the general decreasing trends of grain number per spike and 1000-grain weight were observed in NWR (Fig. 2b and c), which was agreement with the previous reports. However, the present results indicate that there was increasing trends in grain yield with heat stress, yet the increasing trends did not reach the significant level (Fig. 2d).

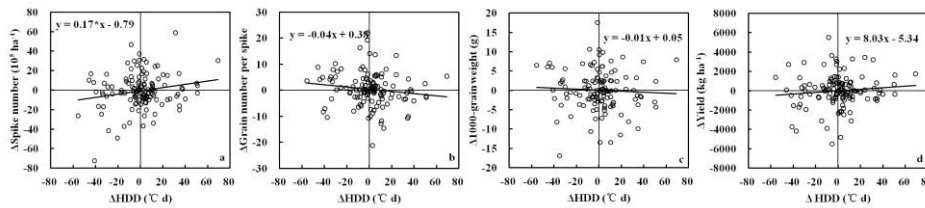

Figure 2. Relationships between year-to-year changes for heat degree-days (Δ HDD) and year-to-year changes for wheat grain yields (Δ Yield), spike number (Δ Spike number), grain number per spike (Δ Grain number per spike) and 1000-grain weight (Δ 1000-grain weight).

Conclusions

Crop models are useful tools in climate impact studies as they deal with multiple climate factors and processes of crop growth and yield formation that are sensitive to climate. However, using crop models to assess the impact of climate change on crop production is an indirect approach. Direct studies on the effects of climate change on crop growth and yield with long term field experiment data could provide more confirmative information. Here our results showed that the rising temperature does not reduce the grain yield of winter wheat under the suitable management practices in the past decades.

Acknowledgements

This study was supported by the National High-Tech Research and Development Program of China (2013AA100404), the National Natural Science Foundation of China (31301234 and 31271616).

Reference

- Cao, W., Moss, D.N. (1997). J. Agric. Sci. 129:163-172.
 Liu, B., Liu, L., Tian, L. et al., (2014). Global Change Biol. 20:372-381.
 Rosenzweig, C., Elliott, J., Deryng, D. et al., (2014). Proc. Natl. Acad. Sci. U.S.A. 111:3268-3273.

Design of african rainfed cotton ideotypes using dssat cropgro-cotton

*R. Loison*¹ – *A. Audebert*² – *P. Debaeke*³ – *E. Gérardaux*¹

¹ CIRAD, UR AïDA, Av. Agropolis, 34398 Montpellier, France, romain.loison@cirad.fr

² CIRAD, UMR AGAP, Av. Agropolis, 34398 Montpellier, France

³ INRA, UMR AGIR, CS 52627, 31326 Castanet-Tolosan, France

Introduction

Crop simulation models (CSM) have been successfully used to study the impacts of increasing climate variability and climate change, and assess adapted cultivars (He et al., 2015; Rötter et al., 2013; Xiao and Tao, 2014). The CSM DSSAT CROPGRO-Cotton was proved effective in predicting cotton yield in African rainfed conditions (Gérardeaux et al., 2013). In Northern Cameroon, cotton (*Gossypium hirsutum* L.) is the main cash crop grown exclusively in rainfed conditions (Sultan et al., 2010). Despite breeding efforts, seed cotton yield has been decreasing steadily since the 80s in Northern Cameroon (Naudin et al., 2010). In order to support breeders in their quest for new cultivars in an uncertain future, optimizing CSM genetic parameters for yield simulation under changing or current climate was reviewed to be efficient in the design of best yielding ideotypes (Rötter et al., 2015). To our knowledge, the use and evaluation of CSM for rainfed cotton ideotype design has never been attempted. In this study, model-based ideotyping will be applied to the conditions of low fertility soils of Far North Cameroon.

Materials and Methods

Crop phenology, morphology, leaf area index (LAI), aerial biomass, yield components and seed cotton yield were measured in 2012 and 2013 in 3 locations of N. Cameroon. In each plot, soil was sampled at planting for water and nutrients contents. Precipitation was measured daily on the fields. Temperature, solar radiation, dew point temperature, and wind speed were recorded daily with synoptic stations located within 10 km from the field. Then, calibration and validation of the CSM were done according to Gérardaux et al., (2013). A simulated climatic series was generated from NASA dataset with WGEN (Richardson, 1985). As candidate ideotypes for the area, 42 virtual cultivars (VC) were designed by modifying within existing ranges the CSM genetic parameters which govern the main plant functions: (i) phenology: phasic duration before and after anthesis, (ii) photosynthesis: maximum assimilation rate and specific leaf area, and (iii) light interception: maximum size of a fully expanded leaf. The VC showing higher average seed cotton yield over the climatic series and for the worst climatic years (environmental indexes ≤ 1), and smaller standard deviation of the mean compared to the reference cultivar are possible ideotypes.

Results and Discussion

DSSAT CROPGRO-Cotton was successfully calibrated and validated in field conditions of N.Cameroon. Indeed, the RRMSE of anthesis date, boll opening date, LAI maximum, and seed cotton yield of calibration dataset were 5.3%, 4.3%, 28%, and 25.7%, respectively. For the worst climatic years (*Figure 1*, environmental indexes below 1), we found that the rejected VC always showed lower seed cotton yields whereas the VC selected as possible ideotypes showed almost always higher seed cotton yields compared to the reference cultivar L484. This ideotype has earlier anthesis date, longer reproductive duration, thicker leaves with higher potential assimilation rate, and smaller leaves as compared to cv. L484. This ideotype seems achievable since leaf thickness, potential assimilation rate and leaf area are positively correlated while no clear correlation exists between vegetative and reproductive durations.

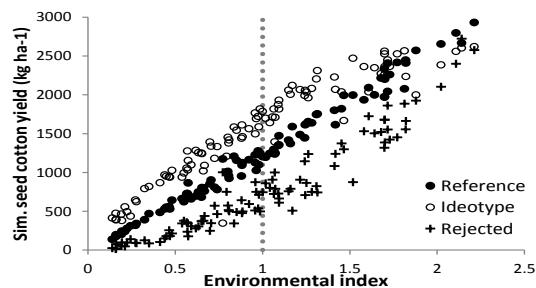

Figure 1. Simulated seed cotton yield over an environmental index (EI) for the reference cultivar L484 (●), the worst VC rejected (+) and the best VC possible ideotype (○). Average seed cotton yield of reference: 1253 kg ha⁻¹, ideotype: 1575 kg ha⁻¹, rejected: 775 kg ha⁻¹. Average seed cotton yield for EI≤1 of reference: 722 kg ha⁻¹, ideotype: 1085 kg ha⁻¹, rejected: 345 kg ha⁻¹. Standard deviation of the mean of reference: 702 kg ha⁻¹, ideotype: 644 kg ha⁻¹, and rejected: 616 kg ha⁻¹.

Conclusions

We concluded that morpho-physiological traits could be imported into breeding programs in F5 generation where high genetic diversity still exists and plant material starts to be considered as a line rather than a single plant. Consequently, we invite breeders to target cultivars with shorter “emergence to anthesis” duration and longer reproductive duration, thicker and smaller leaves and high chlorophyll content under the lowest available water conditions.

Acknowledgements

This study was funded by the agreement between Sodecoton (Société de développement du coton camerounais), IRAD (Institut de Recherche Agricole pour le Développement) and CIRAD (Centre de coopération Internationale en Recherche Agronomique pour le Développement).

References

- Gérardeaux, E., Sultan, B., Palai, O., et al., (2013). *Agron. Sustain. Dev.* 33, 485–495.
 He, L., Asseng, S., Zhao, G., et al., (2015). *Agric. For. Meteorol.* 200, 135–143.
 Naudin, K., Goze, E., Balarabe, O. et al., (2010). *Soil Tillage Res.* 108, 68–76.
 Richardson, C.W. (1985). *Trans. ASAE* 28, 1602–1606.
 Rötter, R.P., Hohn, J., Trnka, M., et al., (2013). *Ecol. Evol.* 3, 4197–4214.
 Rötter, R.P., Tao, F., Höhn, J.G. et al., T. (2015). *J. Exp. Bot.* erv098.
 Sultan, B., Bella-Medjo, M., Berg, A., et al., (2010). *Int. J. Climatol.* 30, 58–71.
 Xiao, D., Tao, F. (2014). *Eur. J. Agron.* 52, 112–122.

Decision Analysis Principles can guide the modeling of complex agroforestry systems

*E. Luedeling*¹ – *K. Shepherd*²

¹ Land Health Decisions, World Agroforestry Centre (ICRAF) and Center for Development Research, University of Bonn, Walter-Flex-Str. 3, 53113 Bonn, e-mail: e.luedeling@cgiar.org

² Land Health Decisions, World Agroforestry Centre

Introduction

Recent years have seen great advances in crop modeling. While progress has been remarkable for many systems, the number of reliable models decreases sharply with increasing system complexity. For complex agroforestry systems, few modeling attempts have been undertaken, with the most promising being WaNuLCAS (Coulibaly et al., 2014), models from the SAFE family (Dufour et al., 2013) and recent advances in adding tree-crop interaction capabilities to APSIM.

In spite of these successes, models with the accuracy and precision exhibited by models for simpler systems are not within reach. Probably the greatest challenge is the complexity and diversity of agroforestry systems. Process-based models would have to consider many relevant system characteristics and processes, such as competition for resources, multi-year crop and tree management and spatial setup. Adding complexity would reduce structural model errors (due to omission of important processes) but increase parameter errors (due to uncertainty about model parameters), limiting the reliability of model outputs (Passioura, 1996). The great diversity of agroforestry systems also hinders the development of generic and widely applicable models.

The second major challenge is uncertainty, resulting from the lack of detailed and comprehensive data on long-term performance of tree-based systems. While a small number of systems has been well researched, application of existing models to new contexts typically requires extensive long-term data collection and often consequential assumptions about parameters that cannot be measured easily. Data scarcity is a particular problem in many tropical countries, where interest in agroforestry is greatest, and where many practices have the greatest potential.

Incremental progress in agroforestry modeling is being made and will continue to be made in the future, but we find it unlikely that the major challenges can be overcome soon. In order to harness the potential of crop modeling for agroforestry, we propose a pragmatic approach based on the principles of decision analysis.

Materials and Methods

We explored the principles of decision analysis for their potential application in modeling agroforestry systems. These principles are widely used in supporting business decisions, in the evaluation of medical evidence, in legal reasoning and in a range of other fields (Fenton and Neil, 2012; Hubbard, 2014). We gained experience with decision analysis approaches through several case studies, in which we

collaborated with decision scientists to jointly model development decisions (e.g. Luedeling et al., 2015). Among the relevant principles are the need to **integrate expert knowledge**, the **inclusion of uncertainty** in predictive models and the use of **information values** for guiding measurements (Shepherd et al., 2015).

Results and Discussion

Integrating expert knowledge into agroforestry modeling processes is indispensable, because hard data are very limited and always context specific. Experiments on tree-based systems are slow to deliver results, and the large number of experiments that would be necessary for clarifying all important system processes makes exclusive reliance on experimental data unrealistic. Without expert knowledge, reliable agroforestry models cannot be developed in the foreseeable future.

Given the extent of the knowledge gaps, it is currently impossible to have confidence in precise performance predictions for agroforestry systems. It is therefore crucial that **uncertainties** about all input parameters are reflected in model outputs, which could be provided as probability distributions or confidence intervals.

The decision analysis principle of **information value** offers guidance on which knowledge gaps are most deserving of scientific attention. While there is often uncertainty about all parameters of a model, there are typically only a few that cause most of the variation in model outputs. Procedures to identify these high-value variables can help guide scarce research resources to where they can generate the greatest gain in model reliability. Finally, the ultimate purpose of models is most often to help stakeholders make better choices or investment decisions on agroforestry interventions. Decision analytic models that combine available data and expert knowledge on agroforestry performance have potential to improve those decisions in the near term.

Conclusions

Decision analysis principles can guide a pragmatic approach to constructing models for complex crop production systems in the absence of robust and abundant data. This requires a departure from the ambition to make precise predictions, in favor of probabilistic model outputs, which honestly reflect our state of uncertainty about model processes and parameters.

References

- Coulibaly, Y.N., L.K. Heng et al., (2014). *Agroforestry Systems*, 88: 13–28.
- Dufour, L., A. Metay et al., (2013). *Journal of Agronomy and Crop Science*, 199: 217-227.
- Fenton, N. and Neil, M. (2012). *Risk Assessment and Decision Analysis with Bayesian Networks*. CRC Press, Boca Raton.
- Hubbard, D. W. (2014). *How to Measure Anything - Finding the Value of Intangibles in Business*. Wiley, Hoboken.
- Luedeling E., A. Oord et al., (2015). *Frontiers in Environmental Science* 3: article 16.
- Passioura, J.B. (1996). *Agronomy Journal* 88, 690-694.
- Shepherd, K., D. Hubbard et al., (2015). *Nature* 523: 152-154.

Agro-climatic indices explaining yield variations in major crops in Germany

A. Lüttger – T. Feike

Institute for Strategies and Technology Assessment, Julius Kühn-Institut | Federal Research Centre for Cultivated Plants, Stahnsdorfer Damm 81, 14532 Kleinmachnow, Germany, Andrea.Luettger@jki.bund.de

Introduction

Climate change is expected to increase variability and occurrence of extreme climate events (Franzke, 2015; Scoccimarro et al., 2015). To be able to adapt to the effects of climate change and ensure agricultural productivity it is crucial to understand how climate influences crop yield variability.

Mechanistic crop modeling approaches are often used to assess the impact of changing climate parameters on crop growth and yields at plot scale. The approaches mainly built on data derived from field experiments, where detailed crop management data is available. However, crop modeling approaches have limitations, when it is about assessing the impact of climatic effects on average actual farm yields on larger spatial scale. For this purpose statistical analysis of historic long-term yield and climate data can help to generate valuable insights on how climatic factors influence yield and inter-annual yield variations. Therefore the current study aims at identifying agro-climatic indices explaining negative yield deviations for different agricultural production regions of Germany and their distinct thresholds.

Materials and Methods

For the present study historical yield data of winter wheat, rapeseed, silage maize and potato were collected from statistical yearbooks and scaled to county level (NUTS 3) from 1956 to 2010.

Based on daily weather data from the German Weather Service (DWD) from 1951 to 2010 a homogenized historical climate data set on station base, interpolated to the centre points of each county was use to emphasize the region-specific differences. Yield and climate data were aggregated to the level of the soil-climate-regions (SCR) (Roßberg et al., 2007). A series of crop specific agro-climatic indices were calculated for each region spanning different seasonal time frames and threshold levels.

Table 1. Overview of selected agro-climatic indices

Indices	Description
NSD_(5, 11)	Number of stress days (NSD) as consecutive days without precipitation for more than 5 days corrected by 5 respectively 11
NHD_(25, 30)	Number of hot days with maximum temperature above 25°C ¹ or 30°C ²

¹ during flowering of winter wheat and ² in July for silage maize

The respective agro-climatic indices were correlated to the negative relative yield deviations defined as deviations of the actual year to the 7-year moving average for winter wheat, silage maize and potatoes. The results for selected relevant agro-climatic indices and three distinct SCRs are presented in the present study (cf. Table 1).

Results and Discussion

In the three regions SCR 102 (East German lowland), SCR 121 (Rhine- and tributary valleys) and SCR 141 (Cologne-Aachen loess land), which feature strongly contrasting soil and climate characteristics, significant differences in the explanatory power of the tested agro-climatic indices can be observed (cf. Table 2). While NSD_5 in WW had a significantly negative effect on yield in SCR 121, the effects were insignificant in the other two regions. With regard to heat stress (NHD_25) significant correlations were found for NHD_25 in SCR 102 and SCR 121. In maize significant effects were evident for drought stress (NSD_5) in SCR 102 and SCR 121, while heat stress showed no significant effect. Similarly in potato, no correlation occurred with heat stress (NHD_30), but NSD_5 was significantly correlated in SCR 102 and SCR 141. For rapeseed no significant correlations were identified (data not shown). The differences among the regions and crops can mainly be explained by differences in intra-seasonal extent of the specific agro-climatic indicator as well as differences in soil characteristics between the three presented regions.

Table2. Correlation between selected agro-climatic indices and negative yield deviations for the three distinct regions and crops

Region	Winter wheat (WW)		Maize		Potato	
	NSD_5	NHD_25	NSD_5	NHD_30	NSD_5	NHD_30
102	-0.39	-0.42*	-0.42*	-0.37	-0.40*	-0.24
121	-0.86***	-0.66*	-0.72**	-0.39	-0.17	-0.04
141	-0.49	0.45	-0.11	-0.28	-0.66*	-0.30

***p<0.001, **p<0.01, *p<0.05

Conclusions

The applied approach was able to identify specific agro-climatic indicators, which help to explain negative yield deviations in major crops in Germany. The derived findings provide useful information for crop modelers to support adaptation of cropping systems to climate change.

References

- Franzke, C. L. E. (2015): Local trend disparities of European minimum and maximum temperature extremes. - *Geophysical Research Letters* 42, 6479-6484.
- Roßberg, D., Michel V., Graf, R. und Neukampf, R. (2007): Definition von Boden-Klima-Räumen für die Bundesrepublik Deutschland. -- *Nachrichtenbl. Deut. Pflanzenschutzd.* 59, 155-161.
- Scoccimarro, E., G. Villarini, M. Vichi, M. Zampieri, P. G. Fogli, A. Bellucci, S. Gualdi (2015): Projected Changes in Intense Precipitation over Europe at the Daily and Subdaily Time Scales*. -- *Journal of Climate* 28, 6193-6203.

Towards A simple model for winter wheat's grain filling dynamics considering heat effects

*A. Luig*¹ – *R. Manderscheid*² – *M. Erbs*² – *A. M. Ratjen*¹ – *H.-J. Weigel*² – *H. Kage*¹

¹ Group of Agronomy and Crop Science, Institute of Crop Science and Plant Breeding, Christian-Albrechts-University, 24118 Kiel, Germany, e-mail: luig@pflanzenbau.uni-kiel.de

² Thünen-Institute of Biodiversity, Federal Research Institute for Rural Areas, Forestry and Fisheries, 38116 Braunschweig, Germany

Introduction

Current crop model algorithms concerning grain growth underly assumptions of determinate grain filling duration and subsequent grain filling rates as a function of vegetative dry matter without considering the influence of temperature, especially canopy temperature (Matre et al., 2006). The use of canopy temperature instead of air temperature seems to more applicable for quantifying the impact of heat stress as it represents the physiological active temperature better and considers the transpiration rate of the canopy, which is driven by atmospheric CO₂ concentrations, plant water status and micrometeorological conditions in the field (Kimball and Bernacchi, 2006). Our objective was to model the key determinants of yield formation, grain number, grain weight and grain protein content, as a function of canopy temperature on basis of field experimental data, which most likely represents reality in crop production systems. In this study we focused on grain weight and grain protein content.

Materials and Methods

In 2013/2014 and 2014/2015 a free air carbon enrichment experiment (FACE; Hendrey and Kimball, 1998) with winter wheat (*Triticum aestivum* cv. Batis) was conducted by the Thünen Institute to test the influence of elevated atmospheric CO₂ concentrations and increasing canopy temperature on the yield parameters. Canopy temperatures were risen by T-FACE technique (Kimball et al., 2009) around anthesis to create short-term heat stress in the daytime and across grain filling to induce long-term warming stress in two temperature treatments during the whole diurnal cycle (+2°C, +4°C). On basis of up to six destructive harvests during the grain filling period grain number and grain weight were measured. The estimation of grain filling rate (GFR_{GDD}) and grain filling duration (GFD_{GDD}) in terms of growing degree days resulted from the fit of logistic growth functions (Robert et al., 1999). With measured canopy temperatures and grain weights GFR_{GDD} and GFD_{GDD} were transformed into grain filling rate (GFR_d) and duration (GFD_d) in terms of days. Same estimation procedures were performed for grain protein filling rate (XP-GFR_{GDD}; XP-GFR_d) and duration (XP-GFD_{GDD}; XP-GFD_d).

Preliminary Results and Discussion

Yield formation of winter wheat reacts to 4 °C higher temperatures with a 5 % decrease of GFR_{GDD} and an elongation of GFD_{GDD} by 9 % whereas the GFR_d increases to an extent of 7 % and GFR_d is 2 days shorter. In a 2 °C warmer temperature environment GFR_{GDD} and GFD_{GDD} were similar to higher temperatures but to a smaller extent while GFR_d and GFD_d remained the same as in the control environment. The differences in incident radiation are not equivalent to differences in intercepted radiation because progressing senescence is not considered yet (Tab.1). FACE treatment resulted in an elongated grain filling period (increase of GFD_d and GFD_{GDD}) because lower transpiration rates of canopies under high CO₂ concentrations led to higher canopy temperatures.

Table 1. Incident radiation, grain filling duration in terms of days (GFD_d) and growing degree days(GFD_{GDD}), for experimental treatments in 2013/2014

	AMBIENT			FACE		
	Control	+2 °C	+4°C	Control	+2 °C	+4°C
GFD_d [days]	33.6	33.9	31.1	34.6	34.0	32.1
Inc. Radiation [MJ/m ²]	659	659	642	677	659	647
GFD_{GDD} [°Cd]	535	563	585	560	591	608

Therefore we hypothesize that the implementation of determinate grain filling duration and subsequent grain filling rates in crop models seem to be not appropriate and suggest an approach by which grain filling is a function of phenology and the development of temperature conditions during grain filling. Grain protein and yield formation reacted similar to heat whereby grain DM filling algorithms seem to be transferrable to estimate grain protein dynamics.

Conclusions

Appropriate modelling of the dynamics of grain weight and protein during grain filling is an important part to get satisfying results displaying winter wheat's yield in crop models under heat stress. Therefore it is inevitable to have further focus on algorithms to calculate grain number and its interaction with grain weight with respect to temperature.

Acknowledgements

This work was funded by German Research Foundation (DFG).

References

- Matre, P., Jamieson, P.D., Semenov, M.A., Zyskowski, R.F., Porter, J.R., Triboi, E. (2006). Modelling protein content and composition in relation to crop nitrogen dynamics for wheat, *Europ. J. Agronomy*, 25, 138-154
- Hendrey, G.R. and Kimball, B.A. (1994). The FACE program, *Agricultural and Forest Meteorology*, 70, 3-14
- Kimball, B.A. and Bernacchi, C.J. (2006). Evapotranspiration, canopy temperature and plant water status relations, *Ecological Studies*, 187, 311-324
- Kimball, B.A. and Conley, M. (2009). Infrared heater arrays for warming field plots scaled up to 5m diameter, *Global Change Biology*, 149, 721-724
- Robert, N., Huet, S., Hennequet, C., Bouvier, A. (1999). Methodology for choosing a model for wheat kernel growth, *Agronomie, EDP Sciences*, 19(5), 405-417

DSSAT model as a tool for water and Nitrogen management in intensive irrigated areas: CALIBRATION AND VALIDATION

W. Malik – F. Dechmi – R. Isla

Soil and Irrigation Department (EEAD-CSIC Associated Unit), Agrifood Research and Technology Centre of Aragon, Avda. Montañana 930, 50059 Zaragoza, Spain, wmalik@cita-aragon.es

Introduction

The DSSAT model has been used worldwide to simulate crop biomass and yield, and soil N dynamics under different management practices and various climatic conditions (Li et al., 2015). There is a continuous need to test and update the models under a wide range of environments and cropping practices (López-Cedrón et al., 2008). This study was focused on the evaluation of the performance of CERES-Maize to study the response (total biomass, grain yield and N uptake) of irrigated maize to different soil nitrogen availability under semi-arid condition.

Materials and Methods

Three maize field experiments using *Pioneer 'PR34N43'* were performed in Montañana 2010 (Mon10), Almodévar 2011 and 2012 (Alm11 and Alm12) (Spain) under sprinkler irrigation system. Five rate of N fertilizer (0 to 400 kg N ha⁻¹) were applied at each field that included four replications. The DSSAT (V4.5) was calibrated using plots managed under optimum N conditions and validated using other plots managed under different soil N available (from 60 to 871 kg N ha⁻¹, preplant soil N+ N fertilizer). To assess the performance of DSSAT, Bias, RMSE and R² were used.

Results and Discussion

The best RMSE of grain yield achieved during the calibration process was about 844 kg ha⁻¹. The DSSAT validation process indicates an overestimation of grain yield, biomass and crop N uptake (Table 1). The best result was obtained in Alm12 site with a RMSE of 1023 kg ha⁻¹ for grain yield and 2516 kg ha⁻¹ for total biomass. The model underestimated the residual soil N in the upper part of the soil profile while overestimated soil N in deeper layers (Table 2).

Table1. Performance (validation) of DSSAT model (Bias, RMSE and R²) to simulate grain yield and total biomass of maize

Field	Grain yield (kg ha ⁻¹)			Total biomass (kg ha ⁻¹)		
	BIAS	RMSE	R ²	BIAS	RMSE	R ²
Mon10	883	2031	0.55***	2516	3656	0.58***
Alm11	271	1340	0.54***	1033	2874	0.46***
Alm12	388	1023	0.83***	1231	2516	0.67***

Table2. Performance (validation) of DSSAT model (RMSE and Bias) to simulate the residual soil N in Alm12.

Prof (m)	BIAS (kg ha ⁻¹)	RMSE (kg ha ⁻¹)
0.0-0.3	-31	49
0.3-0.6	8	17
0.6-0.9	11	15
0.9-1.2	9	13

DSSAT model tended to overestimate the total nitrogen content in grain and plant (Figure 1). The obtained RMSE were 51 and 42 kg N ha⁻¹ for plant and grain N uptake respectively. An additional calibration modifying the CTCNP2 parameter value allowed an improvement of grain N and total crop N uptake RMSE by 22% and 14%, respectively. A good agreement was obtained between observed and simulated grain yield and a moderate agreement for total plant N uptake comparing with other studies (Liu et al., 2012; Salmerón et al., 2014).

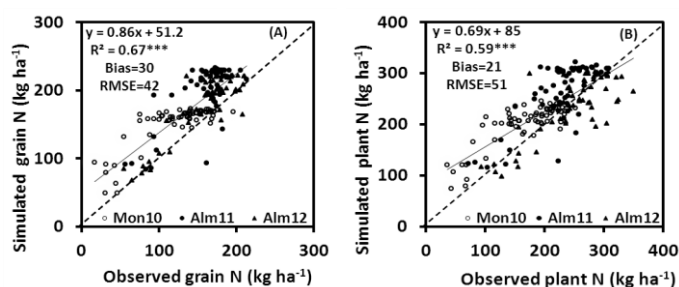

Figure 1. Relationship between simulated and observed of (A) grain N and (B) plant N uptake (kg N ha⁻¹) in the three experiments (Mon10, Alm11 and Alm12; n=158). The dashed line represents the 1:1 relationship.

Conclusions

The model evaluation could be considered acceptable comparing with other published works. However, the model calibration and validation needs to be improved with further data. A better CTCNP2 parameter adjustment to specific field conditions is important to obtain more accurate maize N uptake estimation. The application of calibrated model could be helpful to assess management practices for reducing N leaching in intensive irrigated area.

Acknowledgments

This work has been financed by the Spanish National Research Plan I+D+i (AGL2009-12897-C02-02 and AGL2013-48728-C2-2R). We thank the IAMZ-CIHEAM and the Spanish National Research Plan for awarding to Wafa Malik a Master and predoctoral fellowships, respectively.

References

- Li, Z.T., J.Y. Yang., C.F. Drury et al., (2015). Evaluation of the DSSAT-CSM for simulating yield and soil organic C and N of a long-term maize and wheat rotation experiment in the Loess Plateau of Northwestern China. *Agricultural Systems*, 135: 90-104.
- Liu, H.-l., Y. Jing-yi, H. Ping et al., (2012). Optimizing Parameters of CSM-CERES-Maize Model to Improve Simulation Performance of Maiz Growth and Nitrogen Uptake in Northeast China. *Journal of Integrative Agriculture*, 11(11): 1898-1913.
- López-Cedrón X.F., K.J. Boote, J. Piñeiro, et al., (2008). Improving the CERES-Maize Model Ability to Simulate Water deficit Impact on Maize Production and Yield Components. *Agronomy Journal*, 100: 296–307.
- Salmerón, M., Cavero J., Isla R., et al., (2014). DSSAT Nitrogen Cycle Simulation of Cover Crop–Maize Rotations under Irrigated Mediterranean Conditions. *Agronomy Journal*, 106(4): 1283-1296.

Effects of free air CO₂ enrichment and drought on canopy development and biomass production of different sorghum genotypes as compared to maize

R. Manderscheid – M. Erbs – H.-J. Weigel

Thünen-institute of Biodiversity, Bundesallee 50, D-38116 Braunschweig, e-mail: remy.manderscheid@ti.bund.de

Introduction

Maize has a high biomass production and therefore is used as an energy crop. Given the increase in temperature and the decrease in summer precipitation as predicted by the IPCC, sorghum could be an alternative energy crop in the future due its better drought tolerance. Therefore we analysed the growth response of maize and different Sorghum-genotypes under increased CO₂ concentration and severe summer drought over two seasons.

Materials and Methods

On cultivar of Maize (Simao) and four cultivars of Sorghum (Bulldozer, Inka, Tarzan, Zerberus) were grown in plots in three rings with free air CO₂ enrichment (=FACE, 600 ppm) and three control (380 ppm) rings. Each ring was split in a WET and DRY semicircle. Water supply was controlled by drip irrigation (WET) and by the operation of rain shelters (DRY, Erbs et al., 2012). The investigation program comprised measurements on environmental conditions (weather conditions, soil water content etc.) and plant growth (LAI, radiation absorption, biomass yield, RUE etc.).

Results and Discussion

Soil water content

Severe drought was only achieved in the second year. In this year dry plots received only half the amount of water as compared to the well-watered plots (Table 1). Drought decreased soil water content and CO₂ enrichment led to higher soil water content under both wet and dry conditions as found in a previous study with another maize cultivar (Manderscheid et al., 2014).

Biomass yield

Biomass yield was significantly affected by genotype and watering, and significant interaction of genotype x watering and CO₂ x watering were detected. Maize showed the highest yield under all conditions and the sorghum cultivar Inka the lowest one. Drought decreased crop growth and this effect was mitigated by CO₂ enrichment dependent on genotype (maize: +18%, Inka: +4%).

Radiation absorption by the canopy

Due to the faster leaf expansion of maize seasonal radiation absorption was about 20% higher as compared to sorghum, which is one mechanism contributing to the difference in biomass yield.

Radiation use efficiency (RUE)

RUE calculated from the growth data were significantly influenced by genotype and watering. Moreover, there were significant interactions of genotype x watering and of CO₂ x watering). This indicates that CO₂ enrichment improves RUE only under drought and that genotypes differ in RUE and its modification by drought. Inka had a lower RUE than Bulldozer and Tarzan, of which RUE was similar to maize.

Field trials from different years and from a cool site (Kiel) with different seasonal temperature means ranging from 13 to 18°C showed a strong decrease of RUE especially for the cultivar Inka at cool temperatures (data not shown). Thus, Inka needs higher temperature for optimum growth.

Table 1. Water supply to WET and DRY plots in the 2nd year.

Water source (mm)	WET	DRY
Rain	224	224
Rain excluded	0	-53
Irrigation	110	0
Total	334	171

Conclusions

Maize performs better than sorghum under drought and CO₂ enrichment under today’s temperature, since sorghum has a higher temperature requirement for canopy expansion and optimum RUE. This difference might disappear if the temperature requirement is changed by plant breeding or if it is getting warmer due to climate change.

Acknowledgements

This project was supported by the Federal Ministry of Education and Research (BMBF). We thank the team of Henning Kage for providing growth data of Inka from a field trial in Kiel.

References

Erbs, M., R. Manderscheid and H.J. Weigel (2012). A combined rain shelter and free-air CO₂ enrichment system to study climate change impacts on plants in the field. *Methods Ecol. Evol.* 3, 81-88.
 Manderscheid, R., M. Erbs and H.J. Weigel (2014). Interactive effects of free air CO₂ enrichment and drought stress on maize growth. *Eur. J. Agron.* 52, 11-21.

Can crop yields be doubled and environmental impact halved in the Danish agriculture?

K. Manevski – U. Jørgensen – P. E. Lærke – Z. Solati

Department of Agroecology, Aarhus University, Blichers Allé 20, 8830 Tjele, Denmark
kiril.manevski@agro.au.dk

Introduction

The present study seeks to answer if innovative crop rotations and perennial crops dedicated for biomass are beneficial in their production and environmental impacts over conventional crops under the Danish climate and soil conditions. The work involves field measurements and mechanistic modelling, and it constitutes a subset of a larger project that also investigates value-added products from biomass that can be supplied by biorefineries (Parajuli et al., 2015).

Materials and Methods

Field experiments started in 2012 on sandy loam soil and coarse sand soils in Denmark and involved 1) innovative four-year biomass-optimized crop rotations including beet, hemp, triticale, maize and green rye, 2) perennial grasses *Miscanthus spp.*, festulolium, reed canary, tall fescue, cocksfoot and grass-clover mixtures, and 3) conventional crops winter wheat-spring barley (the most common crops in rotation), continuous maize and triticale. Crop (cuts for dry matter) and soil sampling (soil water content and suction cups below root zone for nitrate analysis) were regularly performed throughout the years. The radiation intercepted by the crops was modelled according to Christensen and Goudriaan (1993) using the remotely sensed canopy reflectance of the plants during their growth seasons. The Daisy agro-ecosystem model (Hansen et al., 2012), calibrated for the climate-crop-soil interactions in Denmark, was used to model soil water- and nitrogen (N) flows in the crop systems. Preliminary results are presented and briefly discussed.

Results and Discussion

Overall, the perennial plants had higher values of intercepted radiation than the annual crops (Fig. 1A), which is mainly due to the growth season. The dry matter and N content of crops already parameterized in Daisy were simulated well (Fig. 1B), except for hemp that was simulated with maize as a proxy (the default photosynthesis-light response curve-does not distinguish between C3 and C4 plants). In addition, the use of proxy crop (ryegrass versus “grass”) to represent the perennial grasses induced difficulties in the simulation of biomass and N content as perennials differ in their re-growth i.e. re-mobilization of assimilates from rhizomes and roots after dormancy or cutting. Both the measurements and the simulations showed low soil nitrate beneath the perennial crop systems, compared to the majority of the annual/grain crops that were characterized with more variable soil nitrate dynamics.

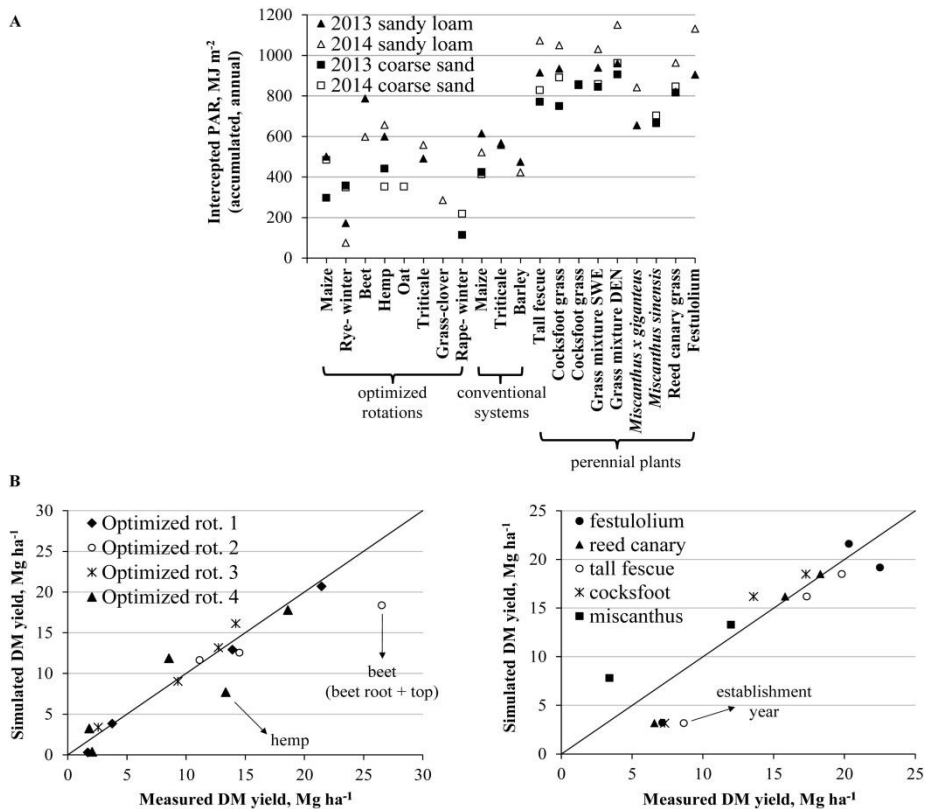

Figure 1. Comparison of (A) intercepted PAR of the annual and perennial crops at the two sites (soil types) in 2013 and 2014, and (B) measured versus Daisy-simulated dry matter yields for sandy loam site in 2012-2014

Conclusions

The Daisy model is mechanistic and often requires detailed input data concerning plant phenology and physiology, but seems to give reasonable fit on the herein newly measured data. Work is ongoing to calibrate the model in order to obtain more reliable water balance for calculation of N leaching from the studied crops, and also to validate the crop production and N dynamics on an independent data.

Acknowledgements

This work is part of the project BIOVALUE SPIR - a strategic platform for innovation and research on value added products from biomass (<http://biovalue.dk/>). BIOVALUE is funded by Innovation Fund Denmark.

References

- Christensen, S., J. Goudriaan (1993). Remote Sensing of Environment 43: 87-95.
 Hansen, S., P. Abrahamsen, C.T. Petersen et al., (2012). Transactions of the ASABE, 55:18.
 Parajuli, R., M.T. Knudsen, T. Dalgaard (2015). Biofuels, Bioproducts and Biorefining 9(5): 545-566

Stochastic model for simulating sugarcane production and uncertainty

*F. R. Marin*¹ – *J. W. Jones*²

¹ Crop Modeling Lab., Department of Biosystems Engineering, College of Agriculture “Luiz de Queiroz”, University of São Paulo, Av. Pádua Dias, 11, Piracicaba-SP, Brazil, fabio.marin@usp.br

² Agricultural and Biological Engineering Department, University of Florida, 289 Frazier Rogers Hall P.O. Box 110570, Gainesville, FL 32611-0570

Introduction

Crop models are increasingly being used for different purposes, including evaluation of climate change impacts on crop yields and opportunities for adapting management to future conditions. However, past uses of these models have been criticized in part due to a failure of researchers to quantify uncertainties of crop yield prediction. This paper describes one potentially useful method for quantifying uncertainty in crop models using a simple sugarcane model as a study case.

Materials and Methods

The model is fully described in Marin and Jones (2014). The model was parameterized and evaluated using plant cane data using the SP83-2847 cultivar, collected in four locations in Brazil. The generalized likelihood uncertainty estimate (GLUE) (Beven and Binley, 1992) method was used with the crop model in order to find the best set of parameters from stochastically generated parameter samples, and to compute the variance-covariance correlation matrix of model parameters. We generated 6000 random sets of the selected model parameters assuming uniform prior distributions within a pre-defined range of variation for each parameter. Based on the comparison of predicted and observed responses, each set of factor values was assigned a likelihood of being a simulator of the system. After that, we normalized the weights such that the sum of all the likelihood values equals one to create a probability distribution for the factor sets. Likelihood values were then calculated for each parameter set using field observations. A posterior covariance structure is obtained when each parameter's combination is weighted via the likelihood measures.

Results and Discussion

The methods used to build the variance-covariance matrix allowed us to evaluate the (linearized) pair-wise interaction structure, which is usually not observable from total sensitivity indices. Parameter relationships were analyzed and in order to reduce the uncertainty of the parameter values. We analyzed the performance of mean of stochastic simulations against the observed data and found that the agreement level was worse than those obtained using the best set of parameters found by the GLUE technique. Uncertainties in crop parameters resulted in variations in both stalk dry mass and sucrose content, and the treatments had a great effect on these variations (Fig. 1). The effect of input parameter uncertainties on the output uncertainty range

for stalk dry mass was generally higher for hotter and drier places (Fig. 2). As sucrose content is computed as composition based on stalk dry mass, the uncertainty range was higher for Piracicaba (Fig. 2).

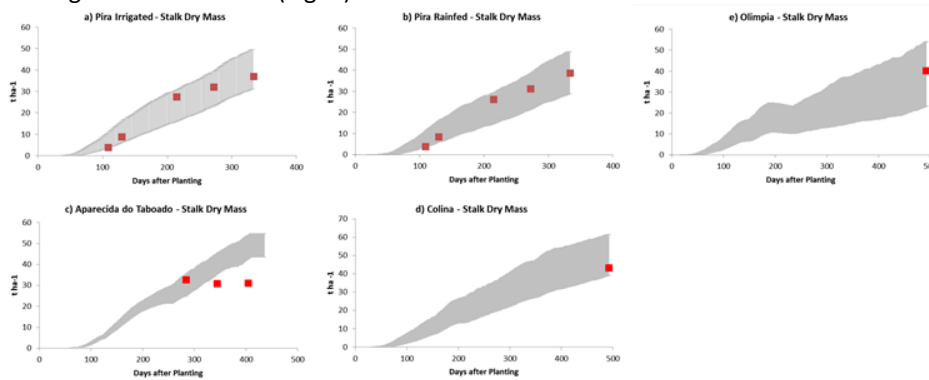

Figure 1. Time variation of simulated stalk dry mass for five datasets of cultivar SP83-2847 using the stochastic approach with correlated random parameter variables. The grey area refer to the variation of one standard deviation around the daily mean value and red squares are the observed data.

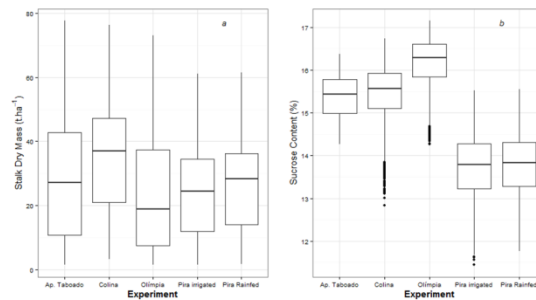

Figure 2. Effect of uncertainty of crop model parameters on uncertainty of harvest-date values of (a) stalk fresh mass (t.ha-1) (b) sucrose content (%) and for five experiments in Brazil for 6000 samples.

Conclusions

The correlated random simulation procedure seems useful for estimating uncertainty in model-based crop growth and yield estimates. The optimization process is heavily dependent on the knowledge of the parameters meaning. The use of correlated random parameter approach reduces the uncertainty in respect of model structure and parameter meaning. Uncertainties in simulated sugarcane model results varied with environmental conditions in this study.

References

- Beven, K., and A. Binley. (1992). The future of distributed models: model calibration and uncertainty prediction. *Hydrological processes* 6 (3): 279–298.
- Marin, F.R., Jones, J.W. (2014). Process-based simple model for simulating sugarcane growth and production. *Scientia Agricola* 71, 1–16.

Investigating the influence of temperature variability on wheat in Bloemfontein using Landsat 8 data

Z. Mashaba^{1,2} – G. Chirima² – J. Botai¹ – L Combrinck¹

¹ Department of Geography, Geoinformatics and Meteorology, Centre for Geoinformation Science, Natural and Agricultural Science, University of Pretoria, Private bag X20, Hatfield, 0028, South Africa, e-mail: MashabaZ@arc.agric.agric.za

² Department of Geoinformatics, Institute for Soil, Climate and Water, Agricultural Research Council

Introduction

Bloemfontein is located in Free State Province and it contributes towards the agricultural production of South Africa including wheat. Climate variability affects farmers in the rural communities of South Africa that rely on agriculture as their main source of sustenance (Tadross et al., 2005). Bloemfontein is no exception to this phenomenon as it is a semi-arid region faced with water scarcity, extremely hot summers and cold winters (DEAT, 2003). High temperatures (~30 °C) accelerate wheat development and decrease the grain filling period which reduces wheat yields (Sharma et al., 2008; Sharma, 1992). Low temperatures (<0 °C) corresponding to periods of frost causes the seedlings to die during the vegetative period and cause sterility during the anthesis period (Barlow et al., 2015). The main aim of the study is to utilize Landsat 8 derived land surface temperature (Kumar and Shekhar, 2015) and compare it with the Normalized Difference Vegetation Index (NDVI) (Lopresti et al., 2015) to derive the relationship between the two parameters for wheat in Bloemfontein.

Materials and Methods

Landsat 8 scenes for path 171 and row 80 for Bloemfontein were acquired for 2013-2015 from the Earth Explorer site. The scenes were selected for the month of July for the study period because winter wheat is at its abundance just before harvesting. The bands were preprocessed using scripts in IDL hosted in the ENVI software according to the processing structure for Landsat 8 data on the USGS site to generate the brightness temperature. The surface temperature calculated had to take into account the emissivity according to the surface temperature equation in Artis and Carnahan, (1982). Finally, the results are used to calculate regression.

Results and Discussion

The results in Figure 1, from this preliminary study indicate that temperature contributes towards the greenness of the wheat. The low surfaces temperatures are linked with high NDVI derived values and the high surface temperatures are related to low NDVI values of the wheat. These are expected results, indicating that remote sensing can play a role in understanding the influence of temperature on wheat. However, more sample points and a long time-series data are required to better understand temporal variations.

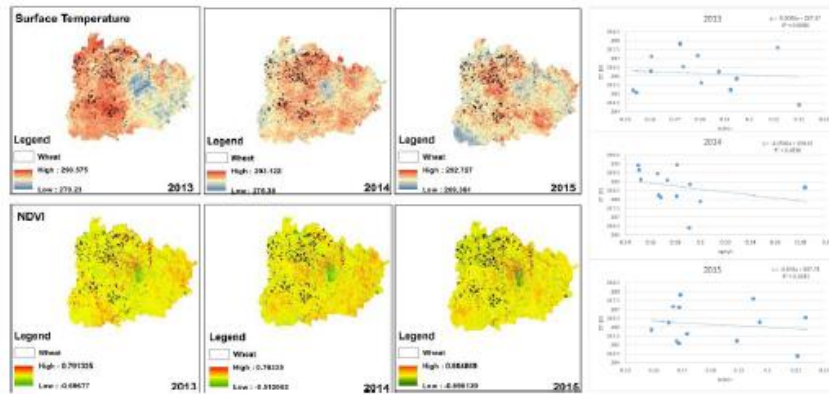

Figure 1. Time series of NDVI and Land surface temperature for Bloemfontein and regression plots.

Conclusions

Given the short time series of Landsat 8 data used in this study, it was demonstrated that temperature plays a crucial role in determining the health status of the wheat. Remote sensing technology can aid in farm management practices and provide valuable information to decision makers. More data are required to fully understand the underlying local and global processes that contributes towards vegetation growth rate and health status. Wheat farms in the Free State Province (including Bloemfontein) require continual monitoring to help with farm management practices.

Acknowledgements

The authors would like to thank the Agricultural Research Council Institute for Soil Climate and Water for funding the project and the Centre for Geoinformation Science at the University of Pretoria for support.

References

- Artis, D. A. and W. H. Carnahan (1982). Remote Sensing of the Environment, 12, 313-329.
- Barlow, K. M., B. P., Christy, G. J., O'Leary, P. A., Riffkin, J. G. Nuttall et al., (2015). Field Crops Research, 171, 109-119.
- DEAT. (2003). Mangaung State of the environment overview report. Department of Environmental Affairs and Technology, Pretoria, South Africa, 1-38.
- Kumar, D. and S. Shekhar (2015). Ecotoxicology and environmental safety, 121, 39-44.
- Lopresti, M. F., C. M., Di Bella, A. J. Degioanni et al., (2015). Information Processing in Agriculture, 2, 73-84.
- Sharma, R. C. (1992). European Journal of Agronomy, 1, 133-137.
- Sharma, R. C., A. K. Tiwary, G. Ortiz-Ferrara et al., (2008). Plant breeding, 127, 241-248.
- Tadross, M. A., B. C. Hewitson, M. T. Usman et al., (2005). Journal of climate, 18, 3356-3372.

Impacts of climate change: a sensitivity analysis to understand the role of soil fertility and water on maize production in the face of climate uncertainty northwest, Zimbabwe

*P. Masikati*¹ – *K. Descheemaeker*² – *O. Crespo*³ – *J. Rurinda*^{4,5}

¹ International Centre for Research in Agroforestry (ICRAF), Lusaka Zambia

² Plant Production Systems, Wageningen University, Wageningen, the Netherlands

³ Climate System Analysis Group University of Cape Town, Rondebosch, South Africa

⁴ Department of Soil Science and Agricultural Engineering, University of Zimbabwe, Harare, Zimbabwe

⁵ International Plant Nutrition Institute (IPNI), Nairobi, Kenya

Introduction

Although climate change is likely to affect a number of development areas in Zimbabwe, the risk to agriculture stands out as very important since it is the mainstay of the country. In the agricultural sector there is limited knowledge on the combined effects of projected increases in carbon dioxide (CO₂) temperature and precipitation variations on crop production, hence adding to uncertainties surrounding future smallholder farming systems and livelihoods. Crop responses depend on factors such as cultivars, management, level of soil degradation, susceptibility to pests and diseases, agrotechnology development and socio-economic condition among others (Ruane et al., 2014). Both climate and agricultural systems are complex and biophysical models are often used to understand the impact of climate change on agricultural systems, investigate crop responses and development of adaptation strategies (Asseng et al., 2015). This study used the Agricultural Production Systems Simulator (APSIM) to assess the sensitivity of maize production to various aspects of climate change that include carbon dioxide, temperature and rainfall under different soils and management practices in a representative semi-arid area of Zimbabwe.

Materials and Methods

Nkayi district in northwest Zimbabwe is located at 19°00' S and 28°20' E. Crop production is rainfed, and average annual rainfall ranges from 450–650 mm. The soils vary from inherently infertile deep Kalahari sands, which are mainly nitrogen- and phosphorus-deficient, to clay and clay loams that are also nutrient-deficient due to continuous cropping without nutrient replenishment. Maize is a dominant crop grown across the district occupying 40-70% of the cropping area (Hommann et al., 2007). To evaluate the combined effects of climate aspects on maize production we used subsets of 5 GCMs (representing relative wet-cool, wet-hot, dry-cool, dry-hot and average conditions) under RCP 8.5 for the mid-century (2040-2070). We further tested the sensitivity of maize to individual climate aspects (CO₂, temperature, rainfall) at different incremental levels. To capture effects of management and soil characteristics, assessments were conducted on 9 soil types which varied in organic carbon (%OC) and plant available water capacity (PAWC) with incremental fertilizer application rates ranging from 0-180 kg ha⁻¹.

Results and Discussion

The maize response to fertilizer reduced at varying levels across soil types and GCMs (Fig 1a). On current soils, which are low in OC (<0.5 % in top layer) and PAWC (<60 mm), the hot-dry scenario resulted in a maximum yield of 1.3 t/ha at a fertilizer application rate of 50 kg N/ha, down from 1.9 t/ha under the current climate. However, on better soils (OC> 0.70 % and PAWC >85 mm) the maximum yield would be >1.7 t/ha at the same application rate and climate conditions (hot-dry). The sensitivity analysis revealed a sudden decrease in grain yield at +2°C, while increased CO₂ resulted in a steady increase of maize grain. Both increased and decreased rainfall can cause grain yields decrease on current poor soils, whereas increased rainfall led to a steady increase of yields on improved soils. Variability of yields under decreased rainfall on improved soils was higher than on poor soils. With a 25% rainfall (current) reduction average yields were 475, 850 and 1215 kg ha⁻¹, on a poor, medium and better soils, respectively (Fig. 1 b-d).

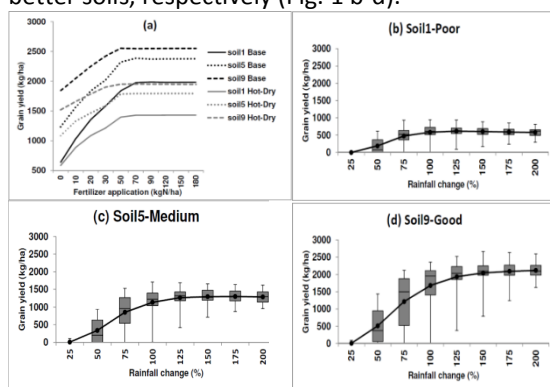

Figure 1a-d. Combined effects of climate aspects (RCP 8.5, GFDL-ESM2M) on maize response to fertilizer application and figures 1 b-d showing sensitivity of maize production under different soils and varying rainfall (values show percent of current rainfall).

Conclusions

With varying impacts of climate change across regions, this study has shown the importance of soil management in mitigating adverse effects. Interventions aimed at improving soil quality will be essential, but there is a need to assess the required quantities of organic matter and also the time required to increase soil OC levels. The use of model based analyses and several climate scenarios allowed evaluation and estimation of likely climate change impacts on maize production under different management practices, which provides valuable insights and guidance for developing climate adaptation strategies in Zimbabwe.

References

Asseng, S., Y. Zhu, E. Wang et al., (2015). Crop modeling for climate change impact and adaptation. *Crop Physiology*. DOI: 10.1016/B978-0-12-417104-6.00020-0

Homann, S., A. van Rooyen, T. Moyo et al., (2007). *Goat production and marketing: Baseline information for semi-arid Zimbabwe*, International Crops Research Institute for the Semi-Arid Tropics. 84pp

Ruane, A. C., L. DeWayne Cecil, R. M. Horton et al., (2013). Climate change impact uncertainties for maize in Panama: Farm information, climate projections, and yield sensitivities. *Agricultural and Forest Meteorology* 170 (2013) 132–145.

Climate impact response surface analysis for maize in Africa

*A. Mechiche-Alami*¹ – *P. Bodin*¹ – *R. P. Rötter*² – *A. Arneith*³ – *S. Asseng*⁴ – *J. Heinke*⁵ –
*M. Hoffman*⁶ – *J. Höhn*² – *J. Jägermeyr*⁵ – *B. T. Kassie*⁴ – *V. Mereu*⁷ – *S. Olin*¹ – *E. Rezaei*⁸
– *J. Seaquist*¹ – *B. Smith*¹ – *A. Trabucco*⁷ – *H. Webber*⁸

¹ Department of Physical Geography and Ecosystem Science, Lund University, 223 62 Lund, Sweden, altaaf.mechiche-alami@nateko.lu.se

² Environmental Impacts Group, Natural Resources Institute (Luke), 01301 Vantaa, Finland

³ Karlsruhe Institute of Technology, Institute of Meteorology and Climate Research/Atmospheric Environmental Research, 82467 Garmisch-Partenkirchen, Germany

⁴ Agricultural and Biological Engineering Department, University of Florida, Gainesville, FL 32611, USA,

⁵ Potsdam Institute for Climate Impact Research, 14473 Potsdam, Germany

⁶ Georg-August-Universität Göttingen, 37077 Göttingen, Germany

⁷ Department of Science for Nature and Environmental Resources (DipNeT), University of Sassari, Italy

⁸ Institute of Crop Science and Resource Conservation INRES, University of Bonn, 53115, Germany

Introduction

In recent years, much effort has gone into assessing the response of staple food crops to climate change using different process-based crop models. However, as these models represent the biogeochemical processes of crop growth differently, outputs differ among the various models as each exhibits its own typical set of uncertainties (Asseng et al., 2013; Challinor et al., 2009; Rötter et al., 2011). In order to reduce model-related uncertainties, many studies are now applying multi-model ensemble simulations for estimating crop yields (Elliott et al., 2015; Tebaldi and Knutti, 2007). While uncertainties in climate impact projections are most problematic and severe for Africa, most ensemble modeling studies have so far focused on European crops and climates (Pirttioja et al., 2015; Rötter et al., 2012).

In this study, we aim to assess the climate sensitivity of a range of crop models using an impact response surface (IRS) approach by evaluating the impacts of temperature, precipitation and CO₂ changes on African crop yields and phenology.

Materials and Methods

This project builds on the IRS Europe study conducted by MACUSR and follows a similar protocol (Pirttioja et al., 2015).

During the first phase of the study, we will evaluate and compare the response of 5 models: LPJmL, DSSAT, APSIM, SIMPLACE and LPJ-GUESS to a wide range of climatic conditions. We will first focus on simulating maize yields and phenology in Ethiopia under both current climate (1981-2010) and perturbed climate; the latter representing plausible ranges of projected temperature and precipitation changes. The selected perturbation range for temperature is between -1 and +6°C (in increments of one degree) and for precipitation between -60% and +60% (in increments of 10% change). We will hold CO₂ constant at its 1990 level for this first phase.

Results will be presented as IRSs, where the sensitivity of model output variables (yields and maturity and harvest dates) to changes in temperature and precipitation will be plotted.

The analysis will later be extended to include more locations in Africa within different climatic zones in order to fully assess the climate sensitivity of all the models and to elaborate a systematic protocol for reducing climatic uncertainty when it comes to multi-model simulations.

Results and Discussion

In a similar study looking at the IRS of wheat yield at 4 sites in Europe it could be seen that the spread between models was largest for the warmest site (in Spain). The difference between models could therefore be expected to be even larger for a warmer climate such as in Ethiopia, but the fact that maize is less sensitive to high temperatures than wheat may compensate for this effect. On the other hand, differences in IRS between models can be attributed to differences in the model representation of various processes related to temperature and soil water. Averaging output variables over larger regions may thus reduce the sensitivity to regional mean climate.

Conclusions

The IRS approach not only explores all potential impacts of future climate change on African crops, but also sheds light on the limitations of each model in properly assessing the impacts of different climatic conditions. This will help identify those models that are most applicable to the different climate zones. It will also serve as a basis for uncertainty reduction when performing multi-model analysis. Finally, it will improve the quality of agricultural adaptation simulations in different African regions.

Acknowledgements

The main author was funded by LUSIT, LUCID. The study is a contribution to the Strategic Research Areas BECC, MERGE and LUCCI (Lund University). The work was conducted in the context of CROP M, the crop modeling component of MACSUR. It also partly builds on work conducted within the EU-FP7 project ClimAfrica.

References

- Asseng, S., F.Ewert., C. Rosenzweig et al., (2013). *Nature Climate Change*, 3: 827–832.
- Challinor, A. J., F. Ewert, S. Arnold et al., (2009). *Journal of Experimental Botany*, 60:2775–89.
- Elliott, J., C. Müller, D. Deryng et al., (2015). *Geoscientific Model Development*, 8: 261–277.
- Kassie, B. T., M.K. Van Ittersum, H. Hengsdijk et al., (2014). *Field Crops Research*, 160:41–53.
- Pirttioja, N., T. Carter, S. Fronzek et al., (2015). *Climate Research*, 65:87–105.
- Rosenzweig, C., J.W. Jones, J.L. Hatfield et al., (2013). *Agricultural and Forest Meteorology*, 170:166–182.
- Rötter, R. P., T.R. Carter, J.E. Olesen et al., (2011). *Nature Climate Change*, 1: 175–177.
- Rötter, R. P., T. Palosuo, K.C. Kersebaum et al., (2012). *Field Crops Research*, 133:23–36.
- Tebaldi, C. and R. Knutti (2007). *Philosophical Transactions of the Royal Society A: Mathematical, Physical, and Engineering Sciences*, 365:2053–2075.

Does crop type matter for simulating water quality?

*B. Mehdi*¹ – *C. Schürz*²

¹ Department of Crop Science, Division of Agronomy, University of Natural Resources and Life Sciences Vienna (BOKU), Konrad-Lorenz Str. 24, 3430 Tulln, Austria, bano.mehdi@boku.ac.at

² Department of Water-Atmosphere-Environment, Institute of Water Management, Hydrology and Hydraulic Engineering, University of Natural Resources and Life Sciences Vienna (BOKU), Muthgasse 18, 1190 Vienna.

Introduction

Agronomic data is a key source of input for several ecological models. However, often the specific crop spatial allocation data or the management input data is not known, or sometimes the data exists but it is very difficult to obtain. The omission of agronomic data can add to the uncertainty in the modelling chain if it is required as input data. In most models the main sources of uncertainty can be attributed to the following 3 components: 1) input data (sampling and measurement); 2) conceptual (structural) uncertainty in the model where processes may not replicate the reality, or processes may be omitted; and 3) parameter uncertainty reflecting scale and/or inexact hydrological knowledge and understanding.

The semi-distributed hydrological model “Soil and Water Assessment Tool” (SWAT; Arnold et al., 1998), like several other water quality models, requires input of crop type, planting and harvesting dates as well as the field management practices to best simulate the amount of nutrients (N and P) transported from the fields. The nutrient losses are calculated using physical equations to transport the loads from the fields to adjacent surface water bodies.

Rouholahnejad et al., (2014) and Abbaspour et al., (2015) used SWAT to simulate the nitrate loads of the Black Sea Basin and the rivers in Europe, respectively, by applying only 3 crop types (wheat, maize and barley) to these areas in the model. The crops were allocated to “agricultural land” in the MODIS land use maps by basing the planted areas in each sub-basin on the proportional contribution to each country’s harvested areas. The question arises: How much of a difference does the crop data input make to the modelled nutrient outputs? Since there is not an alternative model set-up for the European continent; it is not possible to verify their results.

Materials and Methods

We set out to determine if the typical mix of crops grown in complex agricultural land use patterns in a watershed could be reduced to 3 main crops and produce statistically satisfactory simulated water quality results at the outlet of the basin. For this study, the Altmühl watershed (980 km²) in Bavaria (Germany) and the Schwechat watershed (960 km²) in Lower Austria (Austria) were chosen as test sites. Detailed crop land use (field level) for 2008 was available from the INVEKOS database for the Altmühl and land use from CORINE was used for Schwechat. In both cases, the land use remained static for the modeling time period from 1970-2000.

In both watersheds, the SWAT model was run twice from 1970-2000; first with the typical complex cropping mixture found in each watershed, and secondly, with a simplified crop set up where each crop was allocated to one of 3 groups based on their most common row spacing. The distance between the crop rows was deemed to be one of the most important factors for governing runoff, erosion and nutrient transport mechanisms (SWCS, 2003). Thus, regardless of whether the crops were perennial or annual, they were divided into: maize, wheat or pasture to represent row spacing of 75 cm, 20 cm and 0 cm, respectively (Table 1).

Table 1. Typical crops grown the Altmühl (2008) with row spacing and their allocation to representative crop types for modelling purposes

Crop type in INVEKOS	Typical row spacing (cm)	Allocated to new crop with row spacing (cm)
Silage corn	75	Silage corn 75
Grain corn	75	Silage corn 75
Soybean	75	Silage corn 75
Potato	60	Silage corn 75
Sugar beet	55	Silage corn 75
Orchard	370	Silage corn 75
Winter wheat	20	Winter wheat 20
Summer wheat	20	Winter wheat 20
Canola	20	Winter wheat 20
Alfalfa	20	Winter wheat 20
Strawberries	38	Winter wheat 20
Pasture	0	Pasture 0

Results and Discussion

SWAT was used to simulate mean monthly sediments, nitrate-nitrogen and total phosphorus loads, with corresponding uncertainty bounds for the Altmühl River and for the Schwechat watershed from 1970-2000. This is an on-going study and results will be compared to historical water quality data from the same time period to determine the degree to which the 3-crop method replicated the measured data.

Conclusions

This presentation will be able to answer the question of whether simulated water quality can provide acceptable results if less crop type data is available as input.

References

- Abbaspour, K.C., Rouholanhnejad, E., Vaghefi, S., et al., (2015). A continental-scale hydrology and water quality model for Europe: Calibration and uncertainty of a high-resolution large-scale SWAT model. *J. Hydrology*. 10.1016/j.jhydrol.2015.03.027.
- Arnold, J.G., Srinivasan, R., Muttiah, R.S. et al., (1998). Large area hydrologic modeling and assessment part I: Model development. *J. Am. Water Res. Assoc.* 34(1): 73-89.
- Rouholanhnejad, E., Abbaspour, K.C., Srinivasan, et al., (2014). Water resources of the Black Sea at high spatial and temporal resolution. *Water Res. Research* 10.1002/2013WR014132
- SWCS (Soil and Water Conservation Society). (2003). Conservation implications of climate change: Soil erosion and runoff from cropland. Soil and Water Conservation Society. Report. 23 pp. Akeny, Iowa.

Desert agricultural systems at the Early Bronze Age settlement of Jawa, northern Jordan – efficiency & potential crop yields

J. Meister^{*} – R. Rettig – B. Schütt

Department of Earth Sciences, Institute of Geographical Sciences, Physical Geography, Freie Universität Berlin, Malteserstraße 74-100, 12249 Berlin, Germany, *j.meister@fu-berlin.de

Introduction

Located in the arid basalt desert of northeastern Jordan, the Early Bronze Age (EBA) settlement of Jawa is by far the largest and best preserved archaeological site in the region (Helms, 1981). Recent surveys in the close vicinity revealed the well-preserved remains of three abandoned agricultural terrace systems, covering an area of 38 ha and utilizing floodwater from nearby wadis or runoff from adjacent slopes, mainly by collecting and diverting water via surface canals (Meister et al., submitted). In order to simulate potential levels of crop yields and to assess how many inhabitants could have been supplied by these systems, this study applies a crop simulation model (CropSyst) under today's climatic conditions. One of our major aims is to evaluate the efficiency of the applied water management techniques and its impact on harvest yields.

Materials and Methods

The environmental conditions and the set time interval under which the crop productivity is simulated, is the rainfall regime of the past 31 years (1983-2014) using daily satellite precipitation estimates (RFE ARC 2 dataset) for Jawa. For simulations, we chose winter barley (*Hordeum vulgare*) since it is documented for Jawa by macrobotanical remains (Willcox, 1981). In order to study frequency and volumes of the runoff (irrigation) events, a runoff time series for each agricultural terrace system and its catchment was generated, applying the SCS runoff curve number method (CN) based on rainfall and soil data. Thereby, we assumed that every sufficient runoff event that was harvested by irrigation measures had a potential impact on crop yield. The results were then used as input parameters in the crop simulation model, simulating crop yields - with and without irrigation measures. Following the distinctive rainfall pattern and the usual harvest sequence of that area, sowing was done shortly after the first greater rainfall event (Helms, 1981), taking usually place in October till December. For simulations, neither fertilization nor tillage operations were applied.

Results and Discussion

Preliminary results from the CropSyst model for years without irrigation showed that it was able to capture the yields over the years realistically well, which was a prerequisite for the crop model to estimate the impact of irrigation on grain yield. With an average yield of 0.26 t ha⁻¹ and a maximum yield of 0.9 t ha⁻¹ of barley without irrigation, the predicted values fit well with expected yields for this region (Helms, 1981). Usually, increased seasonal rainfall resulted in increasing yields. In some years, however, crop

failures occur - most probably related to the occurrence and distribution of rainfall events and the selection of individual sowing dates. Model uncertainties are caused by the use of computed weather- and soil parameters by CropSyst (e.g. solar irradiance) and the estimation of others (e.g. saturated soil conductivity, water content). The results for simulating yields of barley for different irrigation scenarios showed that yields usually increase considerably with an increased availability of water (irrigation amount). The average scale between yields with and without irrigation is about 1:4. By contrast, a decrease of yields with increasing irrigation amounts, as observed in some years, is probably related to the fact that CropSyst is not able to simulate drainage, leading to too wet soil conditions and reduced crop growth.

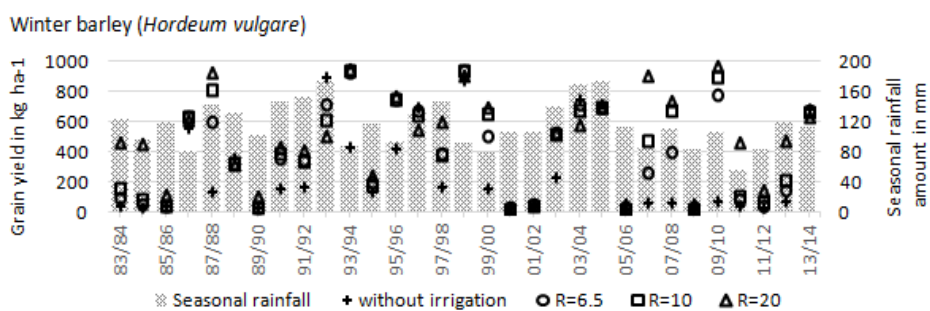

Figure 1. Rainfall and simulated grain yield for barley with and without irrigation, depending on the catchment area (Ratio R = total catchment area to the total area of cultivation).

Conclusions

Results from CropSyst showed that the irrigated terrace agriculture practiced in Jawa during the Early Bronze Age, potentially increased the crop yields significantly. When compared with rainfed yields, the higher levels of barley yields through irrigation imply that even simple water management techniques are - and probably were in the past - highly effective in this area. Further analyses and model adjustments to improve the simulation results are in preparation.

Acknowledgements

We are grateful to the excellence cluster of TOPOI (Exc. 264) - "The Formation and Transformation of Space and Knowledge in Ancient Civilizations" for funding this study.

References

- Helms, S.W. (1981). Jawa: Lost city of the black desert. Methuen & Co. Ltd, London.
- Meister, J., Krause, J., Müller-Neuhof, B., Portillo, M., Reimann, T., Schütt, B., (submitted). Reconstructing agricultural activities at the Early Bronze Age settlement of Jawa, northern Jordan: A multi-proxy approach to integrating archaeological and paleoenvironmental records. *Quat. Int.*
- Willcox, G. (1981). Appendix D. Plant remains, in: Jawa: Lost City of the Black Desert. Cornell University Press, New York, pp. 247–248.

Quantifying the threat to global wheat production and quality from ozone pollution

G. Mills^{1} – K. Sharps¹ – D. Simpson² – H. Pleijel³ – M. Broberg³ – H. Harmens¹ – F. Hayes¹ – L. Emberson⁴ – P. B ker⁴ – Z. Feng⁵ – F. Dentener⁶*

¹ Centre for Ecology and Hydrology, Deiniol Road, Bangor, LL57 2UW, UK, *gmi@ceh.ac.uk

² Chalmers University, Gothenburg, Sweden

³ University of Gothenburg, Sweden

⁴ SEI, University of York, UK

⁵ Research Center for Eco-Environmental Sciences, Chinese Academy of Sciences, Beijing, China

⁶ European Commission, JRC, Italy

Introduction

At the global scale, ozone (O₃) pollution has been predicted to pose as big a threat to food security as climate change by 2030 (Royal Society, 2008). Formed from complex photochemical reactions involving pollutants from vehicle, industrial, agricultural and other emissions, O₃ pollution is present in most of the agricultural areas of the world. Several of the world's most important crops such as wheat, soybean, maize and rice respond to O₃ pollution by decreasing vegetative growth, seed production and root growth leading to reductions in both quantity and quality of yield (Mills et al., 2007). Even though negative effects have been detected in the field under current ambient O₃ concentrations (e.g. Mills et al., 2011), O₃ is not currently included as a modifier of crop growth in global and regional crop modelling.

In this paper we describe a new development in quantifying losses from O₃ pollution for wheat on a global scale based on modelling the stomatal uptake of O₃. Evidence from European chamber and field studies shows that the uptake of O₃ by stomata (flux) is a superior predictor of O₃ damage, compared to more conventional exceedance of O₃ threshold concentrations (e.g. Mills et al., 2011). This analysis presents a major step forwards from previous predictions of risk based on O₃ concentration as it includes the modifying effects of climate and soil moisture (including irrigation) on instantaneous O₃ uptake and subsequent effect. We discuss methods for quantifying uncertainty in the analysis and show how we can model the effects of different crop growth cycles or pollution scenarios.

Materials and Methods

Given the scarcity of O₃ flux measurements worldwide, the EMEP MSC-W global chemical transport model was used to compute stomatal uptake fluxes (Simpson et al., 2015) globally for 2010 – 2012. The phytotoxic O₃ dose above a threshold flux of 3 mmol m⁻², was combined with agro-management information on wheat production and irrigation usage (GAEZ v3.0, <http://gaez.fao.org/Main.html#>) and maps were generated using a 1 by 1 degree resolution grid in ArcGIS (v. 10.1).

Results and Discussion

Our analysis showed that wheat crops in many areas of the world are being negatively impacted by the pollutant (Figure 1). The worst problems were identified for China, India and the USA where economic losses of ca. 4.5, 3 and 2 billion dollars were predicted, respectively. Globally, percentage effects were greater for the temperate climates of the northern rather than the southern hemisphere, in part reflecting the higher O₃ concentrations in the northern hemisphere. Effects were greatest in warm-temperate-dry areas of China and tropical-dry areas of India where irrigation is commonly used resulting in conditions that are highly conducive to O₃ uptake. Estimates based on stomatal uptake of O₃ were lower than those for commonly used concentration-based metrics such as the 7h mean and AOT40.

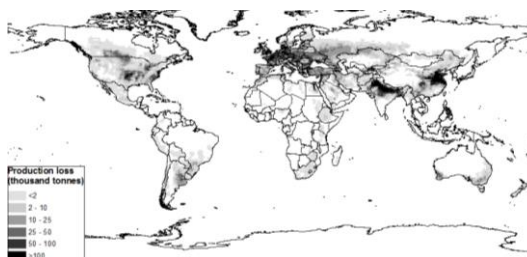

Figure 1. Stomatal uptake based assessment of annual wheat production losses (thousand tonnes per 1° x 1° grid square) due to ozone pollution averaged over 2010-2012.

Conclusions

This study has highlighted the spatial variability of global impacts of ozone pollution on wheat production. It also draws attention to the need to consider ozone pollution as a modifying factor in global crop production and food security modelling.

Acknowledgements

NERC (UK), EMEP-UNECE and the EU ECLAIRE project are thanked for funding this study

References

- Mills, G., Buse, A., Gimeno, B., Bermejo, V., Holland, M., Emberson, L. and Pleijel, H. (2007a). Atmospheric Environment, 41 2630-2643.
- Mills, G., Hayes, F., Simpson, D., Emberson, L., Norris, D., Harmens, H., Büker, P. (2011). Global Change Biology 17, 592-613.
- Royal-Society (2008). Ground-level ozone in the 21st century: future trends, impacts and policy implications. Science Policy Report 15/08.
- Simpson, D.; Tsyro, S. & Wind, P. (2015), Updates to the EMEP/MSC-W model, Transboundary particulate matter, photo-oxidants, acidifying and eutrophying components. Status Report 1/2015, The Norwegian Meteorological Institute, Oslo, Norway, 129-138

YIELDSTAT – a regional yield model for agricultural crops applicable for East-Germany

W. Mirschel – R. Wieland – M. Berg – K. Groth

Institute of Landscape Systems Analysis, Leibniz-Centre for Agricultural Landscape Research (ZALF), Eberswalder Str. 84, 15374 Müncheberg, Germany, wmirschel@zalf.de

Introduction

Climate change and food security are topics of global interest. Worldwide they are the drivers for creating simulation tools to predict crop growth and crop yield at a regional scale as basis for adaptation strategies of agriculture for future challenges. Process-based yield models usually perform well at the point scale, but may fail dramatically at the regional scale. Furthermore, process-based models often need to be corrected for practice-level yields (Nendel et al., 2013). Statistical yield models seem to offer a robust alternative at the regional scale, where they also impress with their higher runtime speed and low demand for input data (Wenkel et al., 2013). Regional crop models have to take into account as many factors as possible, soil, weather, pest and diseases, agro-management decisions, and trends in climate, plant breeding and agro-technology. If the model has a simple structure, it can easily be transferred to other regions. The regional yield model YIELDSTAT (YIELD estimation based on STATistics) presented here accounts for the most mentioned factors including the detailed site-related factors. YIELDSTAT calculates yields for a wide range of agricultural crops.

Materials and Methods

YIELDSTAT is a statistical hybrid-model which was developed on the base of thousands of field records taken from about 300 agricultural farms over a 15 years period starting in 1975. These field records were taken from crop and grassland sites across all existing cropping and climatic regions of East-Germany. YIELDSTAT is based on a matrix of yields (Y_M) representing site-specific average crop yields under rain-fed conditions (Kindler, 1992). The Y_M matrix is used with a number of modifiers to produce actual yield estimates (Y) for different site-crop combinations. The modifiers are: Y_{Site} - site-specific yield modifier, f_{PrCr} - pre-crop modifier, f_{Till} - tillage modifier, Y_{Tech} - regional crop yield trend driven by progress in plant breeding and agro-technology, f_{CO_2} - factor accounting for the effect of increasing atmospheric CO_2 on crop photosynthesis and water use efficiency, Y_{Irri} - yield increase by irrigation and Y_{LoHa} - yield loss caused by adverse weather conditions during harvest. Y is given as follows:

$$Y = ((Y_M + Y_{Site}) \cdot f_{PrCr} \cdot f_{Till} + Y_{Tech}) \cdot f_{CO_2} + Y_{Irri} - Y_{LoHa}$$

The necessary YIELDSTAT input data are: spatial weather / climate data (temperature, precipitation, global radiation) in a daily resolution and the spatial site and soil information taken from the Mesoscale Agricultural Site Map for arable land (soil type, stoniness in the top soil layer, slope, hydromorphy) (Schmidt and Diemann, 1991). Additional map information is necessary for the soil quality index, for the mesoscalic

climatic zones and for altitude. A detailed description of algorithms for the matrix and all modifiers and model input data are given by Mirschel et al., (2014).

YIELDSTAT is implemented in two software systems: the Spatial Analysis and Modeling Tool SAMT (Version 3.1; Wieland et al., 2015) and the LandCaRe-DSS for impact assessment and adaptation strategy development of agriculture to climate and land use changes (Wenkel et al., 2013). Additional for model investigations and simulations YIELDSTAT exists as stand-alone software using an interactive user interface.

Results

Figure 1 shows an example of the assessment of climate change impact on winter wheat and winter rapeseed yields for the Free State of Saxony, Germany, using the YIELDSTAT model and the WEREX A1B climate scenario.

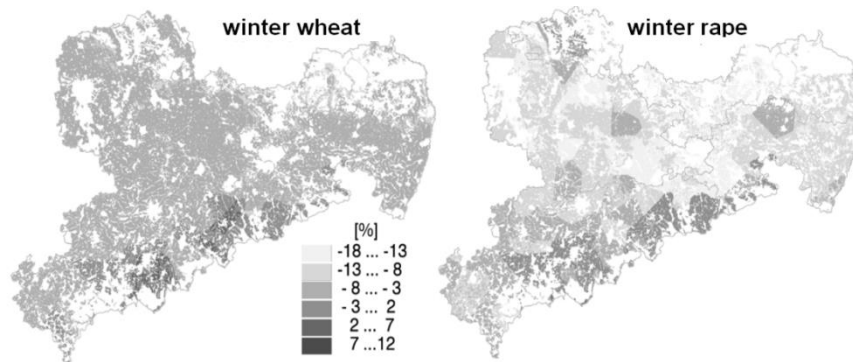

Figure 1. Relative change in crop yield (2021-2050 vs. 1976-2005) for winter wheat (left) and winter rapeseed (right) using the WEREX A1B climate scenario (here without CO₂ increase and without trend)

Acknowledgements

The development of the YIELDSTAT model was supported by the Federal Ministry of Food and Agriculture and the Ministry for Science, Research and Culture of the Federal State of Brandenburg.

References

- Kindler, R. (1992). Ertragsschätzung in den neuen Bundesländern. Verlag Pflug und Feder GmbH, St. Augustin, 230 pp.
- Mirschel, W., R. Wieland, K.-O. Wenkel, C. Nendel, C. Guddat (2014). YIELDSTAT - a spatial yield model for agricultural crops. *European Journal of Agronomy* 52: 33-46.
- Nendel, C., R. Wieland, W. Mirschel, X. Specka, C. Guddat, K.C. Kersebaum (2013). Simulating regional winter wheat yields using input data of different spatial resolution. *Field Crops Research* 145: 67-77.
- Schmidt, R., R. Diemann (1991). Erläuterungen zur Mittelmassstäbigen Landwirtschaftlichen Standortkartierung (MMK). FZB Müncheberg, Bereich Bodenkunde/Fernerkundung Eberswalde, 78 p.
- Wenkel, K.-O., M. Berg, W. Mirschel, R. Wieland, C. Nendel, B. Köstner (2013). LandCaRe DSS – An interactive decision support system for climate change impact assessment and the analysis of potential agricultural land use adaptation strategies. *Journal of Environmental Management* 127, Supplement, S168-S183.
- Wieland, R., K. Groth, F. Linde, W. Mirschel (2015). Spatial Analysis and Modeling Tool Version 2 (SAMT2), a spatial modeling tool kit written in Python. *Ecological Informatics* 30: 1-5.

Sugarcane spatial variability in Brazil: potential, best farmer's and actual yields

*L. A. Monteiro*¹ – *P. C. Sentelhas*^{1,2}

¹ Department of Biosystems Engineering, ESALQ, University of São Paulo, Piracicaba, SP, Brazil.

² E-mail: pcsentel.esalq@usp.br

Introduction

The rapid demand for food and energy has required methods which allow to identify more appropriated regions for an efficient crop production. Due the privileged geographic position (almost all territory in the tropical zone), Brazil has leading the sugarcane world production during the last four decades, presenting a harvested area of around 10 million hectares, being follow by India, China, Thailand and Pakistan with a harvested area of 5.1, 1.8, 1.3 and 1.1 million hectares (FAO, 2014). Based on that, the objective of this study was to determine and mapping the sugarcane yield in Brazil.

Materials and Methods

An agrometeorological yield model was employed to determine the potential (Y_p) and best farmer's yield (Y_{bf}) for all production regions in Brazil (from 1984 to 2013). The yield model was based on Agroecological-zones approach (Doorenbos & Kassam, 1979) and was properly calibrated and evaluated with yield data from twelve sugarcane fields across the country; all conducted under high technology practices, for both rainfed and irrigated crop systems. The input weather data were taken from NASA/POWER system, but rainfall was replaced by the locally stations (ANA). Finally, the actual yield (Y_{avg}) was taken from Brazilian Institute of Geography and Statistics (IBGE, 2014) for each Brazilian micro region from 1990 to 2012 (23 years).

Results and Discussion

Eight zones of Y_p can be identified (Figure 1a), ranging from less than 100 Mg ha^{-1} in the extreme south, where the crop yield is limited by the lower solar radiation, air temperature and photoperiod conditions during the winter, to more than 220 Mg ha^{-1} in the interior of Northeast region. The Y_{bf} (Figure 1b) also varies considerably among the Brazilian macro regions, what is mainly influenced by the soil water availability, showing a strong relationship with the rainfall, crop evapotranspiration and water deficit along the sugarcane cycle. On average, the Y_{bf} in Brazil is 85.7 Mg ha^{-1} (CV = 17.6%), varying between 61.7 Mg ha^{-1} in the state of Rio Grande do Norte (RN) and 105.7 Mg ha^{-1} in the state of Mato Grosso do Sul (MS). In the Southeast region, the average Y_{bf} was 88.8 Mg ha^{-1} (CV = 13.3%), with the state of São Paulo (SP) presenting the highest average Y_{bf} of 100.7 Mg ha^{-1} (CV = 6.6%), whereas the lowest average Y_{bf} was observed in the state of Minas Gerais (MG), with 82.9 Mg ha^{-1} (CV = 12.1%), which is due to the contribution of the lower yields observed in the Center-North of this

state. Yavg presented a huge spatial variability across Brazil (Figure 1c), mainly due to diversity of crop managements applied in different regions.

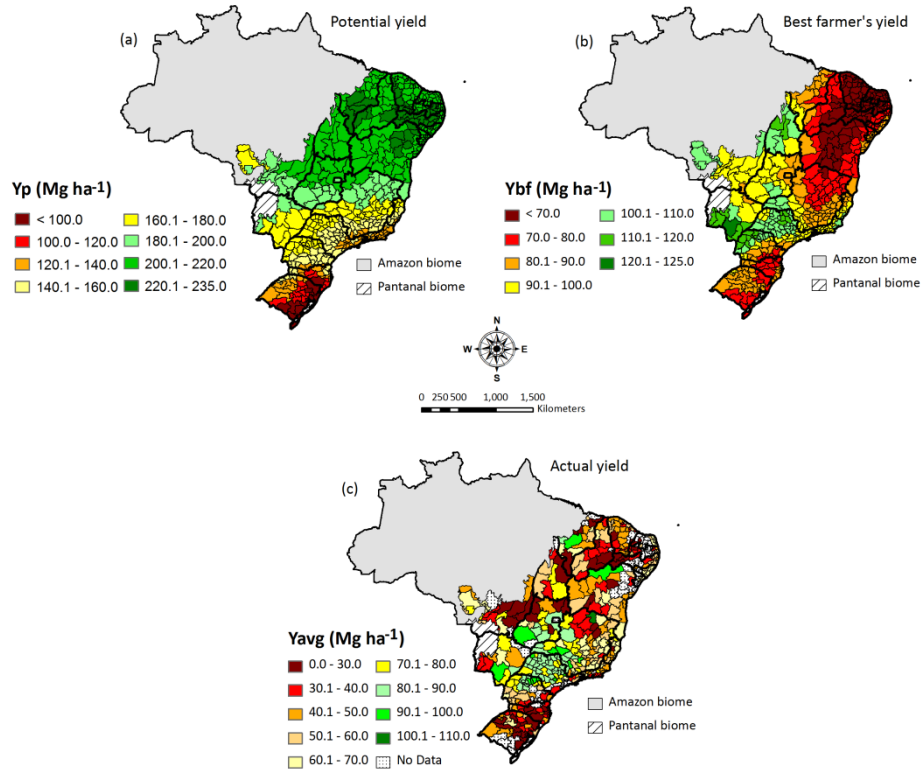

Figure 1. Spatial variability of sugarcane average (a) potential, (b) best farmer's and (c) actual yield.

Conclusions

The detailed yield maps provided reliable information concerning sugarcane yield and then can be employed for a more efficient agricultural planning, mainly in regions with scarce or missing weather and soil data.

References

- Doorenbos, K. and A. M. Kassam (1979). Irrigation and Drainage Paper n° 33, 300 pp.
 FAO. FAOSTAT (2014). Available in: <<http://faostat.fao.org/>>. Accessed in: 03 Oct. 2014.
 IBGE (2014). Available in: <<http://sidra.ibge.gov.br/>>. Accessed in: 05 Oct. 2014.

Cassava: an indeterminate challenge

*P. Moreno*¹ – *J. Cock*¹ – *S. Gourdj*¹ – *M. Fisher* – *J. Ramirez-Villegas*²

¹ International Center for Tropical Agriculture (CIAT), A.A. 6713, Cali, Colombia, l.p.moreno@cgiar.org

² School of Earth and Environment, University of Leeds, Leeds, UK CGIAR Research Program on Climate Change, Agriculture and Food Security (CCAFS), Cali, Colombia International Center for Tropical Agriculture (CIAT), Cali, Colombia

Introduction

Cassava is the fourth most important source of calories in the developing world. Contrasted with other crops, cassava has better drought tolerance, water-use efficiency and resilience to low fertility soils (El-Sharkawy, 2006; Howeler, 2012).

Cassava has potential for intensification throughout the world. In Asia, yields increased 161% over the last 50 years, the harvested area increased 87% and production 390% (FAO, 2014). Yields in Asia are higher than elsewhere with better agronomy that satisfies the demand for cassava chips and starch (Howeler et al., 2013).

The current cassava sub-model of DSSAT was Matthews and Hunt's (1994) GUMCAS model adapted to the CROPSIM wheat sub-model. CROPSIM was for determinate crops with distinct phenological phases, which was not well-suited to an indeterminate crop like cassava.

We present a new version of the DSSAT cassava sub-model which replaces the concept of phenological phases with crop harvest at maturity. The algorithms for branching, individual node weight, potential leaf size, leaf appearance and leaf duration allow for continuous growth with no fixed end of the growth cycle.

Materials and Methods

We defined the algorithms from results of research over the last 40 years by CIAT and other institutions. Some examples of the research uses in the model are Irikura et al., (1979), Lian and Cock (1979) and Porto (1983).

The model was redesigned and based on cohorts of phytomers. The development of each cohort of nodes is tracked according to the original model of Cock et al., (1979). The spillover model use in the model of Cock et. al.(1979) and GUMCAS (Matthews & Hunt, 1994)has been reincorporated with no phasic initiation of root thickening. A novel nutrient restriction on leaf and stem growth was introduced which reflects cassava's characteristic maintenance of leaf nutrient content and reduction of leaf and stem growth when nutrient stress occurs. This restriction takes into account the balance between available carbohydrates and nitrogen.

We fitted functions to the data with CurveExpert (Hyams, 2014) and assembled them in Simile (Muetzelfeldt and Massheder, 2003) to visualize their interactions. We then put them into the DSSAT code, which we reorganized from one block of almost 10,000 lines into 43 subroutines and 2 modules.

Results and Discussion

Branching: Branching is driven by thermal time with the initial thermal age and branching interval set as cultivar coefficients. The cardinal temperatures were set at 13, (24–35), 42°C for the minimum, (optimum), maximum temperatures.

Leaf appearance: A cultivar coefficient and the cumulative thermal time above the cardinal temperatures specified in GUMCAS models the rate of leaf appearance.

Individual node weight: A logistic power curve describes the daily increase of node weight, modified by a temperature factor and a cultivar coefficient. After each 20 nodes the curve is adjusted to reduce the growth rate of later formed nodes.

Potential leaf size: Thermal age of the plant at the time of the formation of a cohort of leaves modified by a cultivar coefficient determines its potential leaf size. At 900 GDD, potential leaf size reaches a maximum and then declines according to thermal time above 20°C.

Leaf duration: There is no evidence that the leaf duration of leaf growth differs with temperature so a fixed growth duration of 10 days was set in the species file. In contrast, the leaf duration is a cultivar characteristic defined by thermal time. Leaves senescence over 60 degree days set in the species file. Older leaves in dense canopies start to senesce when the LAI exceeds a threshold value set in the species file.

Conclusions

We think the algorithms in this new DSSAT cassava sub-model represent the development of cassava under tropical conditions. The model incorporates a new approach to nutrient stress which is appropriate for plants that reduce growth, rather than nutrient concentration when stressed. Although, the capacity to manage water stress and variation in photoperiod has been reduced in the current version of the model, the model structure is such that that both can be readily incorporated as new algorithms are developed.

Acknowledgements

We acknowledge Tony Hunt's adaptation of GUMCAS to CROPSIM and his, Gerrit Hoogenboom's and John Hargreaves' contribution to the project. CIAT's Decision and Policy Analysis Area supported the project with input from the Cassava Program.

References

- Cock, J., Franklin, D., Sandoval, G., & Juri, P. (1979). *Crop Science*, 19(2), 271.
- El-Sharkawy, M. (2006). *Photosynthetica* 44: 481-512.
- FAO, (2014). FAOSTAT (Database). Rome, Italy: FAO. Retrieved from data.fao.org.
- Howeler, R. (2012). Centro Internacional de Agricultura Tropical (CIAT). Retrieved from cgspace.cgiar.org/handle/10568/55577.
- Howeler, R., N. Litaladio, and G. Thomas, (2013). Retrieved from fao.org/docrep/018/i3278e/i3278e.pdf.
- Hyams, D. G. (2014). Retrieved from docs.curveexpert.net/curveexpert/pro/_static/CurveExpertPro.pdf
- Irikura, Y., J.H.Cock, and K. Kawano (1979). *Field Crops Research*, 2: 227–239.
- Lian, T. and J. Cock (1979). *MARDI Research Bulletin*, 7: 55–69.
- Matthews, R. and L. Hunt, (1994). *Field Crops Research*, 36: 69-84.
- Muetzelfeldt, R. and J. Massheder (2003). *European Journal of Agronomy*, 18: 345–358.
- Porto, M. (1983). The University of Arizona, PhD Thesis. Retrieved from arizona.openrepository.com/arizona/handle/10150/187582.

Influence of stomatal behaviour on cucumber leaf water-use efficiency

D. P. Moualeu – T.-W. Chen – H. Stützel

Department of Vegetable Systems Modelling, Institute for Horticultural Production Systems, Faculty of Natural Sciences, Leibniz Universität Hannover, e-mail: moualeu@gem.uni-hannover.de

Introduction

Stomatal pores found on the surfaces of the majority of the aerial parts of plants are the major pathway for water loss from plants. These pores control the fluxes of gases between the outside atmosphere and the leaf interior, and therefore ultimately control the amount of CO₂ uptake by the leaf for photosynthesis (A_{net}) and, consequently, the amount of water lost by leaves through evapotranspiration (E) (Lawson et al., 2014).

Water use efficiency (WUE) is one of the traits that give an idea of the variation amongst genotypes in ability where water is limiting. It is defined as the ratio of dry matter production to water use (Hubick et al., 1986). Although several studies have reported considerable variation in WUE among crop (Ehdaie et al., 1991), direct measurement of the dynamics of WUE efficiency remains problematic.

A dynamic model for Cucumber leaf has been developed for examination of the role of the dynamics properties of the stomata in regulating leaf WUE. The model coupled a dynamic stomatal conductance model, with the dynamics of solute accumulation in the mesophyll, mesophyll water content and sap flow to the mesophyll to quantify the effect stomatal parameters on WUE.

Materials and Methods

Fully expanded leaves of Cucumber plant (*Cucumis sativus*, 'Aramon') grown in the greenhouse of the Institute of Horticultural Production Systems, Leibniz Universität Hannover, Germany (52.5°N, 9.7°E) in summer 2014 were used for the model. The experimental setup was similar to the experiment described by (Kahlen and Stützel 2007). For measuring the dynamics of sapflow into the leaves (water flux through petiole), mini heat field deformation sensors (HFD, Hanssens et al., 2013) were installed from 29 to 31 July 2014 for model analysis and plants in another greenhouse from 05 to 07 August 2014 for the model validation. The local light intensities were measured with PAR sensors (LI-190, LI-COR, Lincoln, USA) positioned directly beside the leaves installed with HFD. Light intensity and sapflow were recorded every minute. Climatic data of the greenhouse was continuously log every twelve minutes. Leaf temperature was measured by a thermal camera (FLIR E60) per hour, and leaf water potential was measured every two hours.

Results and Discussion

The model successfully reproduced the diurnal trend courses of water potential in the mesophyll, water inflow in the mesophyll and relative water content. Simulated water inflow fitted with the sapflow dynamics of the leaves. Comparison of WUE under

different light fluctuating conditions reveals a higher WUE on cloudy days than on sunny day.

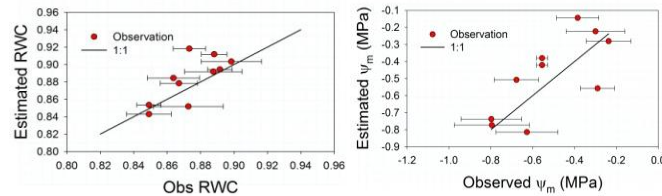

Figure 1. Diurnal trend courses of relative water content in the mesophyll and mesophyll water potential

Table 1. Influence of stomatal speed on water use efficiency during the sunny and cloudy days scenarios

Scenarios	Stomatal parameter values	WUE (mmol CO ₂ mol ⁻¹ H ₂ O)	
		Recorded sunny day, 06.08.2014	Recorded Cloudy day 07.08.2014
Estimated data	$\alpha_g = 4.052 \cdot 10^{-3}$ $r_0 = 2.674 \cdot 10^{-3}$	3.912	5.017
Fixed $r_0 = 2.674 \cdot 10^{-3}$	$\alpha_g = 6.82 \cdot 10^{-3}$	3.912	5.024
	$\alpha_g = 1.34 \cdot 10^{-3}$	3.913	4.999

Decreasing the time constant for stomatal response increased slightly the WUE in all scenarios as can be seen in Figure 1. However, the change was not distinctive for both sunny and cloudy day (roughly 0.6 and 0.7 %). Faster stomatal conductance will lead to a better WUE in case of slowly decreasing light intensity. This result tells us that manipulating the stomatal speed to increase will not only lead to an increase of Carbon gain, but also to an increase of water lost through transpiration.

Conclusions

A fast stomatal aperture time is advantageous for carbon gain, but also increases the evapotranspiration rate, that lead to a decrease of WUE. However, the decrease may not exceed 1% daily WUE when the time constant for stomata aperture is doubled.

References

- Hanssens, J., T. de Swaef, N. Nadezhkina, K. Steppe (2013). Measurement of sap flow dynamics through the tomato peduncle using a non-invasive sensor based on the heat field deformation method. IX International Workshop on Sap Flow 991, S. 409–416.
- Hubick, K. T., G. D. Farquhar, R. Shorter (1986). Correlation between water-use efficiency and carbon isotope discrimination in diverse peanut (*Arachis hypogaea*) germplasm. *Aust J Plant Physiol.* 13, 803-.
- Kahlen, K., H. Stützel (2007): Estimation of geometric attributes and masses of individual cucumber organs using three-dimensional digitizing and allometric relationships. *Journal of the American Society for Horticultural Science* 132 (4), 439–446.
- Lawson, T., A. J. Simkin, G. Kelly, D. Granot (2014): Mesophyll photosynthesis and guard cell metabolism impacts on stomatal behaviour. *New Phytologist* 203 (4), 1064–1081.

Impacts of climate change and variability on yields for selected maize cultivars grown in southern Tanzania

H. I. Mtonqori^{1,2} – *F. Stordal*¹ – *R. E. Benestad*³ – *S. M. Kajumula*⁴ – *M. E. Pereira-Flores*⁵
– *F. Justino*⁵

¹ Department of Geosciences, University of Oslo, P.O. Box 1022 Blindern 0315 Oslo, Norway

² Tanzania Meteorological Agency, P.O.Box 3056, Dar es Salaam, Tanzania

³ The Norwegian Meteorological Institute, P.O. Box 43 Blindern, 0313 Oslo, Norway

⁴ Department of Crop Science and Production, Sokoine University of Agriculture, Morogoro, Tanzania

⁵ Applied Meteorology Program Agricultural and Environmental Engineering Department. Federal Viçosa University, Viçosa, MG36570 000 Brazil

Introduction

Among factors controlling agricultural productivity in Africa, the most important are soil fertility and rainfall (Moore et al., 2012). While total seasonal rainfall is important in crop production (Cooper et al., 2008); the nature of within season variability also has a major effect on crop productivity. Dry spells (Barron et al., 2003) have been identified as a limiting factor to crop yields, even without significant reductions in seasonal rainfall totals. Maize, which is investigated here, appears to be relatively tolerant to water deficits during the vegetative growth stage, but not during the tasselling and ear formation (Çakir, 2004).

Materials and Methods

DSSAT-CSM v 4.5 (Jones et al., 2003) was used to simulate maize yields based on yields from on-farm trials, weather data from an AWS, and soil data. Maize varieties were chosen by farmers; UH6303, H628 and PAN691. We have performed a series of perturbation experiments covering the period from sowing to physiological maturity, using the growing season for the year used in calibration (2013/14) as a baseline. Dry days were introduced for consecutive 10/20 day periods ranging from 5 days before planting (i.e. 10th Dec) up to the expected maturity time (mid-June).

Results and Discussion

With 10 consecutive dry days induced, there was a yield reduction of up to 6% for all cultivars when water stress was induced in the period after flowering and before physiological maturity (Figure 1). This corresponds well with the grain filling stage. The yield loss due to dry days differed among cultivars during vegetative stages. For H628 the loss was up to 28% through flowering (tasselling); while for PAN961 the reduction was about 6%. However, there was a substantial deviation between farmers practice and recommended management cases in the yield changes at vegetative stages. The longer dry spells (20 days) resulted in much more severe yield reductions averaging 20% for UH6303, 38% for PAN961 and up to 43% reduction for H628. For all cultivars, reduction in yields was experienced right away from early vegetative stage through flowering to around filling stage.

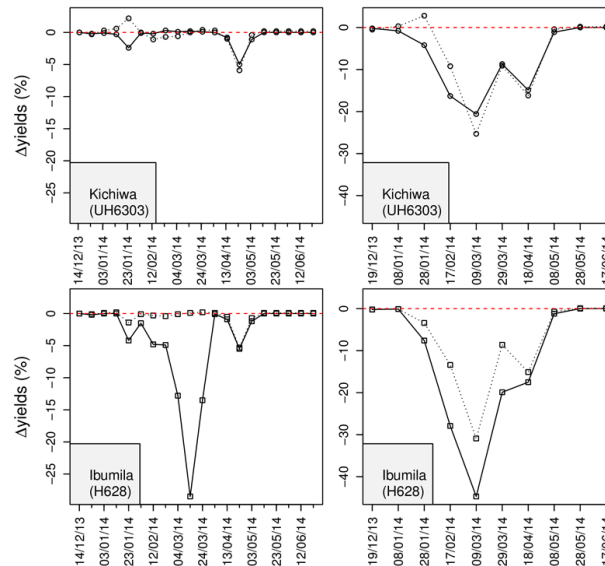

Figure 1. Percentage change in maize yields as a result of water stress in different stages of growing cycle in Southern Tanzania. The left panels represent stress for 10 consecutive days while the right panels represent stress for 20 consecutive days. Solid lines are for recommended management and dotted lines for farmer practice. For each farm location, Kichiwa and Ibumila, the planted maize cultivar is indicated in the bracket.

Conclusions

It is clear that both dry spells and decreased rainfall intensity in the growing season have negative impacts on yields. The severity depends on the stage of growing when the stress occurs

Acknowledgements

This work was supported by CCIAM Project funded through the Norwegian Embassy in Tanzania.

References

Barron, J., Rockström, J., Gichuki, F. and Hatibu, N. (2003). Dry spell analysis and maize yields for two semi-arid locations in east Africa. *Agricultural and Forest Meteorology* 117: 23-37.

Çakir, R. (2004). Effect of water stress at different development stages on vegetative and reproductive growth of corn. *Field Crops Research* 89:1-16.

Cooper, P. J. M., Dimes, J., Rao, K. P. C., Shapiro, B., Shiferaw, B. and Twomlow, S. (2008). Coping better with current climatic variability in the rain-fed farming systems of sub-Saharan Africa: An essential first step in adapting to future climate change? *Agriculture, Ecosystems & Environment* 126:24-35.

Jones, J. W., Hoogenboom, G., Porter, C. H., Boote, K. J., Batchelor, W. D., Hunt, L. A., Wilkens, P. W., Singh, U., Gijsman, A. J. and Ritchie, J. T. (2003). The DSSAT cropping system model. *European Journal of Agronomy* 18:235-265.

Moore, N., Alagarswamy, G., Pijanowski, B., Thornton, P., Lofgren, B., Olson, J., Andresen, J., Yanda, P. and Qi, J. (2012). East African food security as influenced by future climate change and land use change at local to regional scales. *Climatic Change* 110:823-844.

Uncertainty and global sensitivity analysis of actual evapotranspiration and crop Yield using SWAP-WOFOST

*M. Mulder*¹ –*J. Kroes*² –*J. van Dam*³

¹ Alterra, Wageningen UR, the Netherlands

² Alterra, Wageningen UR, the Netherlands

³ Soil Physics and Land Management, Wageningen University, the Netherlands

Introduction

Estimation of the actual evapotranspiration and the actual crop yield using a hydrology-crop model (SWAP-WOFOST) is complex. Wide ranges of variables need to be set in order to have realistic model output. A regression-based sensitivity analysis can be used to identify large uncertainty contribution of input-variables in relation to specific model output, indicating that it would be worthwhile to get to know more about these inputs.

Materials and Methods

The first study site, called 'Dijkgraaf', is located in the center part of the Netherland. The main crop on this site has been maize (*Zea mays L.*) grown on a Haplic Gleysol (Jans et al., 2010). The second site was located on a field at the experimental farm at Vredepeel, located on sandy soils in the southern part of the Netherlands. The main crop has been beets (*Beta vulgaris L.*) (Van Groenigen et al., 2005).

In this study we perform a regression-based sensitivity analysis (the relation between the model output y , and the model inputs $f(x) = f(x_1...x_k)$ is approximated by a regression relation). The analysis of the contribution of (groups of) inputs to prediction uncertainty is based on the regression approximation (Saltelli et al., 1999). The total uncertainty is the variance of $f(x)$ induced by the randomness of all sources x_i . The uncertainty contribution of x_i , or a group of inputs will be expressed in the Top Marginal Variance (TMV). The confidence limits are obtained by so called bootstrap-method.

The coupled hydrology-crop model SWAP-WOFOST (www.swap.alterra.nl) is used to estimate the actual evapotranspiration and actual crop yield. 22 model input-variables have been selected (parameterization of ET, CO₂, pheno, and stress) and their contribution to 17 output-variables (ET, theta, DM) was analyzed.

Results and Discussion

Figure 1 shows the uncertainty in the simulated actual evapotranspiration at site Dijkgraaf in 2007 based on the given distributions of input-variables. The yearly average actual evapotranspiration simulated was 226 mm (with 95% confidence interval between 180 - 260 mm).

Table 1 shows the uncertainty contribution to the simulated actual evapotranspiration for a selection of the input-variables (using linear analysis). At site Dijkgraaf, the input-

variable for light use efficiency for real leaf (EFF) has the most influence, at site Vredepeel this is the crop reflection coefficient (ALBEDO). Similar analyses have been made to identify the input-variables with large contribution in the simulated crop yield. The percentage of variance accounted for by the regression (using linear analysis) is around 80 – 90%.

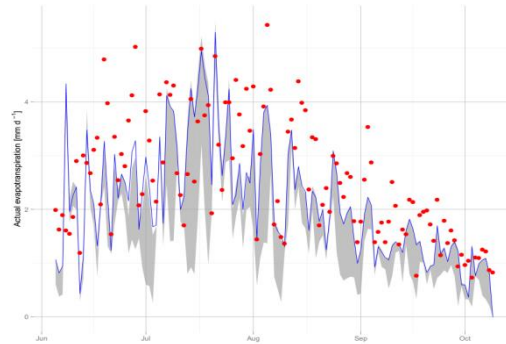

Figure 1. Uncertainty of simulated actual evapotranspiration plotted against observations (Dijkgraaf).

Table 1. Uncertainty contribution of selected input-variables to the simulated actual evapotranspiration at site Dijkgraaf and Vredepeel.

Input Variable	Dijkgraaf		Vredepeel	
	TMV (%)	95% confidence interval (%)	TMV (%)	95% confidence interval (%)
EFF	22.8	(18.2 – 26.9)	8.9	(4.8 – 12.8)
TSUMEA	18.1	(14.4 – 23.3)	10.3	(6.6 – 15.0)
SLATB	12.3	(8.7 – 15.9)	8.1	(5.2 – 11.7)
KDIF	8.1	(5.5 – 11.5)	1.8	(0.6 – 3.8)
ALBEDO	0.0	(0.0 – 0.9)	26.2	(21.3 – 31.3)
...				
Total	88		84	

Conclusions

With a relative simple regression-based sensitivity analysis it is possible to identify the input-variables with a large uncertainty contribution in simulated actual evapotranspiration and actual crop yield.

References

- Jans, W. W. P., C. M. J. Jacobs, B. Kruijt, J. A. Elbers, S. Barendse, E. J. Moors (2010). Carbon exchange of a maize (*Zea mays* L.) crop : Influence of phenology. *Agriculture, Ecosystems and Environment*, 139, 316–324.
- Van Groenigen, J. W., P. J. Georgiuis, C. van Kessel, E. W. J. Hummelink, G. L. Velthof, K. B. Zwart (2005). Subsoil 15N-N₂O Concentrations in a Sandy Soil Profile After Application of 15N-fertilizer. *Nutrient Cycling in Agroecosystems*, 72(1), 13–25.
- Saltelli, A., S. Tarantola, K.P.S. Chan (1999). A quantitative model-independent method for global sensitivity analysis of model output, *Technometrics* 41: 39-56.

**Modeling the impacts of climate change on Agrosystems’
functioning: how can we make the best use of both large-scale
vegetation and plot-scale Process-Oriented models ?**

*N. de Noblet-Ducoudré¹ – I. G. de Cortazar Atauri² – J. Caubel^{1,2} – S. Wieruszkeski¹ –
A - C. Vivant¹ – M. Launay²*

¹ Laboratoire des Sciences du Climat et de l’Environnement, Unité Mixte CEA-CNRS-UVSQ, Orme des Merisiers, 91191 Gif-sur-Yvette cédex, France; julie.caubel@avignon.inra.fr

² AGROCLIM, Unité de Service 1116, INRA centre de recherche PACA, 228 route de l’Aérodrome, CS 40 509, Domaine Saint Paul, Site Agroparc, 84914 Avignon cédex 9, France.

Abstract

Existing methodologies to quantify potential impacts of climate change scenarios on the functioning of agrosystems at large spatial scales use either statistical models (e.g. Lobell and Burke, 2010) or global vegetation models that are either empirically based and only simulate the functioning of crops (e.g. Derying et al., 2011) or process-based and include the simulation of both natural and managed ecosystems (e.g. Bondeau et al., 2006, Berg et al., 2011). We herein propose another methodology that tries to make the best (and combined) use of both global land-surface models (hereafter DGVMs), statistical methods and plot-scale crop process-based models. The idea is first use the DGVMs and statistical indicators to identify ‘hot-spot’ areas at the large scale, i.e. areas where crops may be significantly sensitive to scenarios of future climate change scenarios, and then run the plot-scale crop models in these hot-spots, to guide the adaptation/mitigation measures.

Such a methodology requests that we first construct relevant indicators, derived from DGVMs’ outputs that provide insights on how sensitive crops may be to the imposed climate scenarios. We propose that those indicators may be constructed by confronting local DGVMs’ outputs to those from plot-scale simulation models. We then suggest the following three-step approach (see Figure):

1. Develop transfer functions by linking outputs from large and plot-scale models. This model intercomparison supposes to perform simulations under the same pedoclimatic conditions. Transfer functions will be applied on DGVMs’ outputs to produce diagnostics (hereafter referred to as biotechnical indicators) that mimic some outputs of the specific models. If they are proved to be valid, we may then assume our large-scale models may be useful to anticipate potential changes in the managed ecosystems functioning resulting from climate change at global scale.
2. Run the large-scale models forced with various climate change scenarios. Run the transfer functions defined in step-1 to derive our so-called biotechnical indicators. Calculate supplementary indices such as those developed by Caubel et al., (2014) that have been proved to be useful for decision-making in the past. From the combination of all those indicators, we will be in a position to derive (using

appropriate statistical methods) the regions (or just the grid-cells) where various crops may be at risk or may face new opportunities to be grown.

- Plot-scale crop models for may then be run on regions (or grid-cells) that have been highlighted in step-2. Steps 1 & 2 allow the identification of specific areas where it is worth a) going deeper into the analysis of what may really happen, b) thinking about changing practices, or more drastically abandoning certain varieties/species in favor of others

In summary we propose that large-scale models and plot-scale simulation models for managed ecosystems are used in a successive manner to be more useful to the decision-making process that always occurs at a rather small spatial scale. We have applied this methodology to France and will illustrate our method over this country.

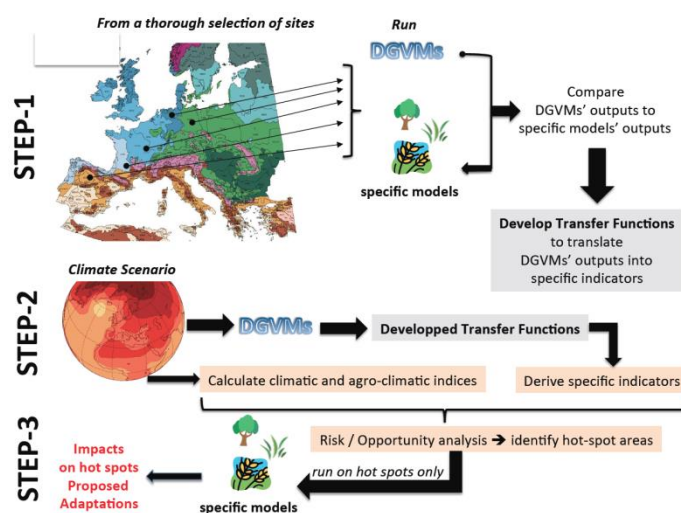

Figure1. Successive steps proposed to make the best use of all available models and tools

References

- Berg, A., N. de Noblet-Ducoudré, B. Sultan, M. Lengaigne and M. Guimberteau (2011): Projections of climate change impacts on potential C4 crop productivity over tropical regions. *Agric. Forest Meteorol.* (2012), doi:10.1016/j.agrformet.2011.12.003.
- Bondeau, A., P. Smith, N. Zaehle, S. Schaphoff, W. Lucht, W. Cramer, D. Gerten, H. Lotze-Campen, C. Müller, M. Reichstein and B. Smith (2006): Modelling the role of agriculture for the 20th century global terrestrial carbon balance. *Global Change Biology* (2006) 12, 1–28, doi: 10.1111/j.1365-2486.2006.01305.x
- Caubel, J., Garcia de Cortazar-Atauri, I., Launay, M., de Noblet-Ducoudr, N., Huard, F., Bertuzzi, P., Graux, A.-I. (2015): 'Broadening the scope for ecoclimatic indicators to assess crop climate suitability according to ecophysiological, technical or quality criteria'. *Agricultural and Forest Meteorology*, 207, 94-106.
- Deryng, D., W. J. Sacks, C. C. Barford and N. Ramankutty (2011): Simulating the effects of climate and agricultural management practices on global crop yield. *Global Biogeochem. Cycles*, 25, GB2006, doi:10.1029/2009GB003765.
- Lobell, D. and M. Burke (2010): On the use of statistical models to predict crop yield responses to climate change. *Agricultural and Forest Meteorology* 150 (2010) 1443–1452.

Simulation modelling of yield losses caused by multiple diseases in American grapevine (*Vitis labrusca* L.)

A. F. Nogueira Júnior¹ – L. Willocquet² – L. Amorim¹

¹ Fitopatologia, Universidade de São Paulo, Escola Superior de Agricultura Luiz de Queiroz, Piracicaba, SP, Brazil, 13418-900, email: a.nogueira@usp.br

² INRA – UMR AGIR, Chemin de Borde Rouge – Auzeville, CS 52627, 31326 Castanet Tolosan cedex, France

Introduction

A modelling explanatory approach is useful to understand how plant physiological processes are affected by crop-pathogen interrelations (Rabbinge and Rijdsdijk, 1981). In particular, the use of crop growth simulation models coupled with damage mechanisms associated to diseases leads to a better understanding of how disease affects growth and yield (Johnson and Teng, 1990; Savary et al., 2006; Willocquet et al., 2000; 2008). The objectives of this work were to (i) develop a simulation model for American grapevine growth which includes damage mechanisms caused by the main foliar diseases of *Vitis labrusca*; (ii) parameterize the damage coupling functions, (iii) rank the damage mechanism importance according to the yield reduction they cause; and (iv) simulate the polyetic damage caused by diseases in *Vitis labrusca*.

Materials and Methods

The system modelled is one grapevine plant (cv. Niagara Rosada), and the model time step is one day. The model runs over a period of five years, in order to address polyetic damage, i.e., damage affecting successive years. The model simulates crop development (crop phenology) in function of the sum of degrees days. Crop growth modeling considers two carbohydrate inputs, (i) from photosynthesis and (ii) from remobilization of roots reserves. The model further considers partitioning of carbohydrates towards the different plant organs and leaf senescence, as well as pruning and fruit harvest. Crop growth model parameters were derived from the literature. Damage mechanisms from downy mildew (*Plasmopara viticola*), grapevine rust (*Phakopsora euvtis*) and anthracnose (*Sphaceloma ampelinum*) were incorporated in the model. The effects of these three diseases on photosynthesis and crop growth were experimentally measured in potted plants.

Results and Discussion

Structure of the grapevine model, including damage mechanisms for three diseases, is displayed in Figure 1. Our experimental results indicate that the three grape diseases reduced LAI (light stealers), leaf biomass (senescence accelerator), pool of assimilates (assimilative sappers), and photosynthesis efficiency (photosynthesis rate reducer). As a consequence the diseases reduced, root and stem biomass. Rust had the highest effect in reducing photosynthesis among the three studied diseases.

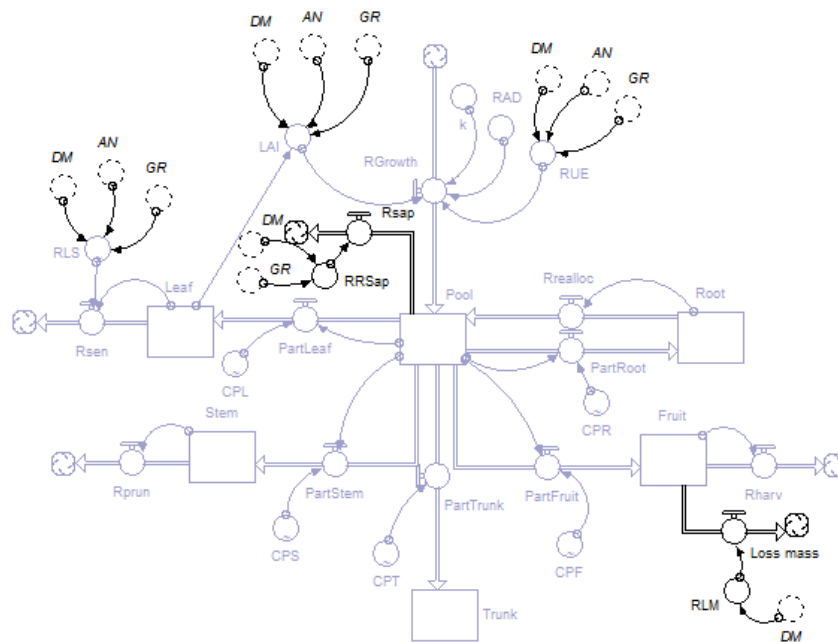

Figure 1. General structure of American grapevine growth model coupling damage mechanisms of downy mildew (DM), grapevine rust (GR), and anthracnose (AN). Damage mechanisms appear in black.

Conclusions

We developed a crop growth model, which simulated (i) grapevine development, (ii) grapevine growth and (iii) yield for 5 years, and (iv) damage mechanisms associated to three diseases. Such a structure allows the study of polyetic damage, and better understanding of damage mechanisms caused by important diseases in American grapevine. Field experiments will be performed in the coming years to test the model.

Acknowledgements

We thank the São Paulo Research Foundation (2013/24003-9) for financial support and CAPES-PDSE.

References

- Johnson, K.B., Teng, P.S. (1990). *Phytopathology*, 80: 416-425.
- Rabbinge R, and Rijdsdijk, F.H. (1981). In: Ayres, P.G.: *Effects of disease on the physiology of growing plant*. Cambridge University Press, Cambridge, UK, pp.201–220.
- Savary, S., Teng, P.S., Willocquet, L. et al., (2006). *Annual Review of Phytopathology*, 44:89-112.
- Willocquet, L., Aubertot, J.N., Lebard, S., et al., (2008). *Field Crops Research* 107: 12-28.
- Willocquet, L., Savary, S., Fernandez, L., Elazeguib, F., Teng, P. (2000). *Ecological Modelling* 131: 133-159.

Intensification options for rice-based systems in Senegal

P. A. J. van Oort

Sustainable Productivity Enhancement, Africa Rice Center (AfricaRice), 01 B.P. 2031, Cotonou, Benin,
p.vanoort@cgiar.org

Introduction

Global demand for agricultural crop production is expected to roughly double by 2050 (Kastner et al., 2012). This challenge can be met by closing yield gaps, bringing new land into cultivation, and using the irrigated land more intensively (van Oort et al., 2015b). The biggest steps in intensification can be made by increasing the number of crops grown per year. Smaller steps in intensification can be made by growing medium instead of short duration varieties. Both intensifications are considered in this paper. In order from least intensive to most intensive we compare the following crop rotations:

1. Rice only (single)
2. Rice-vegetable (double)
3. Rice-rice (double)
4. Rice-rice-vegetable (triple)
5. Rice-rice-rice (triple)

Materials and Methods

The research is situated in the middle valley of the Senegal River in the Sahel. Sowing and harvesting are often delayed by lack of labour, machinery, seed and other resources. Therefore we also consider the “flexibility” of the 5 options above, i.e. how much time there can be between two or crops while still fitting both in one year. Rice crop yields and phenology were simulated with a version of the ORYZA2000 model adapted to the Sahelian environment (Van Oort et al., 2015a). A new model was developed for constructing double and triple crop rotations. Special features of the model are:

1. The cropping calendar model can be linked to standalone models for single crops (such as WOFOST and ORYZA2000);
2. A minimum duration between two crops can be specified; we set this to 20 days;
3. The model works well across calendar years;
4. Different parts of the year can be blocked for vegetable cropping. December-April (5 months) is a normal duration for onion and tomato in the study area. We used the scenarios with 2 month vegetables to explore if triple cropping would be possible if such a short duration vegetable could be found.

Yields were simulated for crops sown once every 10 days, during 20 years to capture the effects of weather variability. We considered short duration varieties, ultra short (-20 days) and medium duration (+20 days) varieties.

Results and Discussion

Cold sterility is the main risk for rice (Fig 1a.). This risk can be avoided, also in double cropping systems, through the choice of appropriate sowing dates. Rice-rice double cropping is feasible, with short duration varieties (70-130 days flexibility, total yield 14.1 t/ha) and medium duration varieties (40-80 days flexibility, total 16.4 t/ha) and yields are almost double that of the highest yielding single rice. Therefore rice-rice double cropping is also economically viable. Rice triple cropping would only be possible with ultra-short duration varieties, with low yields per crop and with a very tight calendar, thus not a feasible option. A rice-rice-vegetable crop would only be possible with a 2 month vegetable and has low (6-45 d.) flexibility.

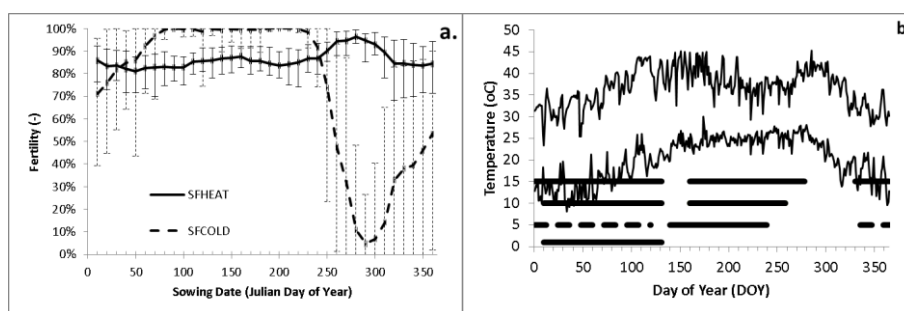

Figure 1a. Heat and cold sterility & Figure 1b optimised cropping calendars and temperature data

Conclusions

A cropping calendar model was developed to investigate options for intensification. The model was applied in rice-based systems in the middle valley of the Senegal River. In this site, it was shown that double cropping is possible in terms of fitting two crops in one year, that intensification by shifting to three crops is unlikely to be viable and that intensification by choosing medium instead of short duration rice varieties is possible if delay between harvesting one crop and sowing the next is not too large.

Acknowledgements

I acknowledge GRiSP, CCAFS and STRASA for funding this research.

References

- Kastner, T., Rivas, M.J.I., Koch, W., Nonhebel, S. (2012) Global changes in diets and the consequences for land requirements for food. *Proceedings of the National Academy of Sciences of the United States of America*, 109, 6868-6872.
- Van Oort, P.A.J., De Vries, M.E., Yoshida, H., Saito, K. (2015a) Improved climate risk simulations for rice in arid environments. *PLoS ONE* 10(3), e0118114
- Van Oort, P.A.J., Saito, K., Tanaka, A. et al., (2015b) Assessment of rice self-sufficiency in 2025 in eight African countries. *Global Food Security* 5: 39-49

Site specific fertilizer recommendation for maize production in the transition zone of Ghana

*O. Onawumi*¹ – *D. S. MacCarthy*² – *F. M. Tetteh*³

¹ Department of Crop & Soil science, Kwame Nkrumah Univ. of Science and Technology, Ghana, oo1470@gmail .com, corresponding author

² Soil & irrigation Centre, School of Agriculture, College of Basic and Applied Sciences, University of Ghana

³ Soil Research Institute, Council for Scientific and Industrial Research, Kumasi, Ghana

Introduction

The use of inorganic fertilizers in Ghana is low due to its cost and risk associated with its use caused mainly by erratic rainfall distribution. To recommend optimal fertilizer levels for farmers require several years of experiment that can be time consuming and expensive. The use of crop simulation models such as the Decision Support System for Agro-technology Transfer (DSSAT) provides the advantage to attain this with limited field experiments. It utilises an approach which integrates data on soils, site information, crops, weather and management practices to estimate crop growth and yield (Jones et al., 2003). The overall objective of the study was set to (1) calibrate and evaluate the performance of DSSAT in simulating maize response to inorganic and organic N (poultry manure) and (2) optimise N fertilizer recommendations for maize production in the forest-Savannah transition zone.

Materials and Methods

The Forest-Savannah transition zone is an important area for maize production in Ghana. It has a bi-modal rainfall pattern with mean annual amounts of 1,350 mm. The two benchmark soils were Chromic Luvisol and Ferric Lixisol. Maize N trials were conducted at two locations (Wenchi and Mampong on the Chromic Luvisol and Ferric Lixisol respectively) in 2013. The N rates evaluated were: 0, 30, 60, 90 and 120 kg N ha⁻¹ and poultry manure (2.5 t ha⁻¹). The experimental design was a randomized complete block design of three replications per site-season. Each plot size measured 6m × 4.5 m with maize plant spacing of 75 cm × 25 cm. The maize variety used was Obatanpa and Mamaba. Data collected on crop phenology and yield were used to calibrate and evaluate model performance (using Root Mean Square Error---RMSE). Subsequently, the model was used to simulate 40 years yield for the various N levels above based on historic weather data for the respective sites. Economic returns on each treatment was calculated based on grain yield and cost of variable input cost.

Results and Discussion

Anthesis and maturity dates were simulated with RMSE of 2.1 days and 3.4 days respectively for *obatanpa* and 1.8 days and 3.6 days respectively for the *mamaba*. Grain and biomass yields were also reasonably simulated with RMSE values of between 142 kg ha⁻¹ and 353 kg ha⁻¹ across sites and cultivars. Maize yield responded to N

fertilization exponentially (Figure 1) at both sites with the response to N being higher in Mampong (Forest zone). The variability in maize yield increased with increasing N application. MacCarthy et al., 2015 reported of similar findings which they attributed to variability in seasonal rainfall distribution. The gross margin analysis indicate higher monetary returns with increase N use. In the Forest zone, 90 kg N ha⁻¹ yielded the highest monetary response while in transition zone, 120 kg N ha⁻¹ yielded the highest returns. The combination of 2.5 t ha⁻¹ poultry manure and 60 kg N ha⁻¹, however, yielded monetary returns similar to those obtained with the use of 90 kg N ha⁻¹ alone at both sites. This offers a good opportunity for smallholders to increase crop yield with moderate use of inorganic fertilizer.

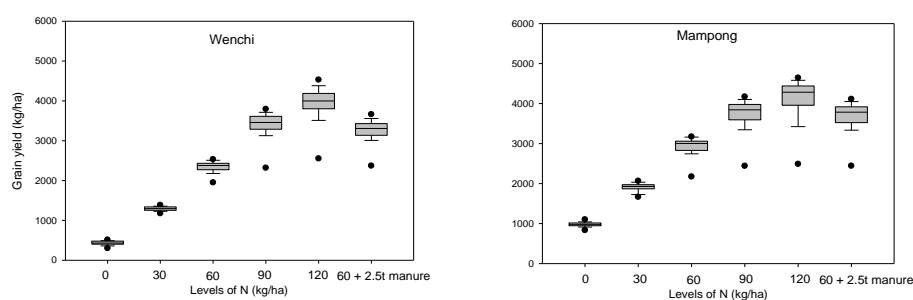

Figure 1. Simulated maize (*Obatanpa*) yield in response to Nitrogen fertilization over 40 years (1970 – 2013) in the Forest (Mampong) and Savannah transition (Wenchi) zones in Ghana.

Conclusions

The DSSAT model performed creditable in simulating the phenology, grain and biomass yield for both maize cultivar at both study locations. While on the economic returns on input, applying 90 kg N ha⁻¹ yielded most economic returns in the Forest zone while 120 kg N ha⁻¹ yielded the most returns in the transition zone. Applying 60 kg N ha⁻¹ with 2.5 t ha⁻¹ manure yielded monetary returns similar to that obtained with 90 kg N ha⁻¹ at both sites. Integrated nutrient management offers a plausible option for smallholders in these sites.

Acknowledgements

Authors are grateful to AGRA and OFRA for providing funding for this research.

References

- Jones, J.W., G. Hoogenboom, C.H. Porter, K.J. Boote, W.D. Batchelor, L.A. Hunt, P.W. Wilkens, U. Singh, A.J. Gijssman, J.T. Ritchie (2003) The DSSAT cropping system model. *European Journal of Agronomy* 18; 235-265
- MacCarthy, D. S., P. B. I. Akponikpe, S. Narh, R. Tegbe (2015) Modeling the effect of seasonal climate variability on the efficiency of mineral fertilization on maize in the coastal savannah of Ghana. *Nutrient Cycling in Agro ecosystems*, 102:45–64

Crop Critical Climate Threshold (CCCT) modelling as an alternative modelling technique to determine the financial impact of climate change on crop yield and quality – a South African case-study

*H. J. Oosthuizen*¹ – *O. Crespo*² – *P. Johnston*³ – *D. B. Louw*⁴

¹ Department Agricultural Economics, Faculty of AgriSciences, Stellenbosch University, South Africa. J.S. Marais Building, Private Bag X1, 7602. hamman@oabs.co.za

² Climate Systems Analysis Group, Dept Env & Geog Science, University of Cape Town, South Africa

³ Climate Systems Analysis Group, Dept Env & Geog Science, University of Cape Town, South Africa

⁴ Department Agricultural Economics, Faculty of AgriSciences, Stellenbosch University, South Africa

Introduction

Numerous studies indicate that the agricultural sector is physically and economically vulnerable to climate change. In order to determine possible impacts of projected future climates on the financial vulnerability of selective farming systems in South Africa, a case study methodology was applied. The integrated modelling framework consists of four modules, viz.: climate change impact modelling, dynamic linear programming (DLP) modelling, modelling interphases and financial vulnerability assessment modelling. Empirically downscaled climate data from five global climate models (GCMs) served as base for the integrated modelling. The APSIM crop model was applied to determine the impact of projected climates on crop yield for certain crops in the study. In order to determine the impact of projected climates on crops for which there are no crop models available, a unique modelling technique, Critical Crop Climate Threshold (CCCT) modelling, was developed and applied to model the impact of projected climate change on yield and quality of agricultural produce. 4 case study sites were selected, two from the summer rainfall and two from the winter rainfall region, with one in each region being rainfed and one irrigated.

Materials and Methods

In the absence of crop models to model the impact of climate change on yield and/or quality of certain crops, a new methodology was developed, i.e. the CCCT modelling technique. The CCCT technique makes provision to calculate the impact of changing climates on yield as well as quality, and is especially suitable for fruit crops. The CCCT modelling technique is based on the following pillars: (a) Empirically downscaled daily climate values (rainfall, minimum and maximum temperatures), (b) Physical/biological critical climate thresholds for different crops, and (c) Expert group discussions (for guidance on crop critical climate thresholds and also the impact on yield and/or quality should a threshold be exceeded). The accuracy of the CCCT technique was verified against APSIM (McCown, 1995) crop modelling results for various crops.

Results and Discussion

For the LORWUA irrigation (winter rainfall) case studies, the crop modelling results are as follows: (a) APSIM modelling - All GCMs project a 20-year average decrease in yield, varying from 9% to 18%, (b) CCCT model - All models project a decrease in yield for wine grapes, table grapes and raisins and a decrease in quality for table grapes.

Crop modelling results for the Carolina (summer rainfall) dry land area (maize, soybeans and sugar beans) are as follows: (a) APSIM modelling - One model projects a decrease (25%) while three models project an increase in average yield of roughly 10%, (b) CCCT model - All models project an average increase in yield of approximately 10%.

For the Moorreesburg (winter rainfall) area (wheat), the CCCT crop modelling results show that despite relatively small variances between the different GCM projections, no major changes in yield, from the present to the intermediate future, are projected. This result correlates with the APSIM crop modelling results, which increases confidence in the CCCT modelling technique.

No crop models were available for citrus and mangoes and only the CCCT technique was applied to the Blyde River irrigation area (summer rainfall). Although, only of five GCMs projects a decrease in yield for citrus, all models project a negative impact on quality. For mangoes a negative impact on both yield and quality are projected.

Conclusions

The positive correlation between the crop modelling results of the APSIM and CCCT modelling for different crops in different regions convinced the researchers that the CCCT technique is suitable to apply as an alternative in the absence of crop models for certain crops and also to determine the impact of changing climates on crop quality. The financial viability results showed that the integrated modelling technique can be used to assess the impact of projected climate change conditions on a variety of crop farming systems.

Acknowledgements

Acknowledgement to the Water Research Commission (WRC) for initiating, managing and funding this research project under the directed call for proposals and to the Department of Agriculture, Forestry and Fisheries (DAFF) for co-funding the project (WRC, 2010).

References

- McCown, R.L., Hammer, G.L., Hargreaves, J.N.G., Holzworth, D. and Huth, N. I. (1995). APSIM - an agricultural production system simulation-model for operational-research. *Mathematics and Computers in Simulation*, Vol. 39 (305).
- Oosthuizen, H.J. (2014). Modelling the financial vulnerability of farming systems to climate change in selected case study areas in South Africa. PhD thesis, Stellenbosch University, South Africa.
- Water Research Commission (WRC). (2010). Adaptive interventions in agriculture to reduce vulnerability of different farming systems to climate change in South Africa. Knowledge review 2009/2010, ISBN no. 978-1-431-0004-7.

Crops and ozone: modern soybean cultivars are more sensitive to ozone pollution than older cultivars, and sensitivity depends on geographic location

S. A. Osborne^{1,2} – *G. Mills*¹ – *F. Hayes*¹ – *E. A. Ainsworth*³ – *P. Büker*² – *L. Emberson*²

¹ Centre for Ecology and Hydrology, Environment Centre Wales, Bangor, LL57 2UW. Email: stepo@ceh.ac.uk

² Stockholm Environment Institute, University of York, York, YO10 5DD

³ USDA ARS Global Change and Photosynthesis Research Unit, Urbana, Illinois 61801

Introduction

The rising concentration of ground-level ozone (O₃) currently being observed in some world regions represents a major threat to agricultural productivity and food security. Soybean (*Glycine max* (L.) Merr.) is highly O₃-sensitive, is crucial in the world food system as a source of protein and animal feed, and is under increasing global demand. Accurate model predictions of O₃ impacts on soybean yield - under both current and future air pollution scenarios - are important for producing risk assessments, and informing air pollution policymakers. The accuracy of crop loss estimates is linked to the accuracy of empirically derived dose-response functions, but functions published to date and incorporated into crop models have been based solely on pre-1998 experiments, conducted only in the USA (Lesser et al, 1990; Mills et al, 2007). This study collates all known dose-response data for O₃ and soybean from experimental studies published between 1982 and 2014, and from a range of geographical locations, to produce an up-to-date response function for incorporation into crop models. We also analyse the dose-response dataset for geographical and temporal patterns which could be driving observed variation in soybean cultivar sensitivity.

Materials and Methods

A search of the published scientific literature was conducted in order to find all O₃ exposure studies conducted on soybean. 30 experimental studies met the inclusion criteria, and when combined produced a dataset comprising 49 cultivars and 384 data points. Linear regression was used to derive the overall soybean dose-response function, and to assess how cultivar sensitivity had changed over time. Stepwise mixed-effect model fitting was used to determine if the sensitivity of soybean cultivars differed by the location of data collection.

Results and Discussion

The dose-response function combined across all cultivars and geographical locations exhibits a similar sensitivity to O₃ as previously published functions. It estimated a yield loss of 17.3% at current O₃ background levels (55ppb 7-hour mean) relative to yield at pre-industrial O₃ concentrations. Importantly, cultivars from India and China showed significantly greater O₃ sensitivity than cultivars from the USA (Figure 1). At an O₃ concentration which has been commonly observed in recent years in India over the

soybean-growing state of Maharashtra, yield loss was estimated to be 9 - 12 % using the combined dose-response function, and 16 - 21% using the India-specific function: a substantial discrepancy of estimation. The data also show that the O₃ sensitivity of soybean cultivars increased by 54.5% between 1960 and 2000 (Figure 2). This trend may be an unintended consequence of selective breeding strategies, which have historically targeted high yielding varieties with high stomatal conductance; and varieties which prioritise rapid growth and development at the expense of defence (Roche, 2015). Alternative cultivar breeding strategies, which target lower stomatal conductance or faster stomatal dynamics, could improve yields - particularly in regions such as South Asia where ozone levels are likely to continue to rise until 2050 (IPCC, 2013).

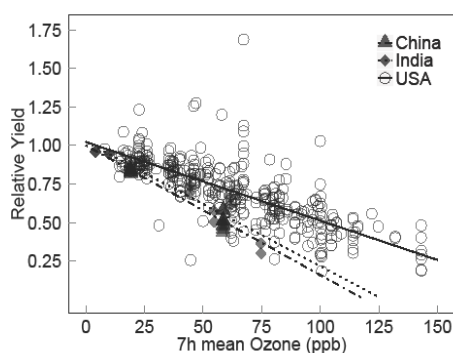

Figure 1. Subdivision of dose-response data by the country in which data collection took place.

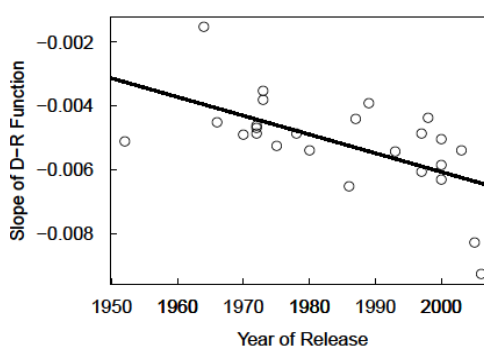

Figure 2. Sensitivity of 25 soybean cultivars expressed using the 7-hour mean metric, plotted against the year in which they were released to market.

Conclusions

The results from this paper demonstrate how region-specific dose-response functions could improve the accuracy of global modelled yield estimates for soybean; and that alternative crop breeding approaches are necessary in order to produce cultivars with enhanced O₃ tolerance.

Acknowledgements

We would like to thank Dr. David Cooper for his valuable advice regarding statistical analyses, and The Natural Environment Research Council of the United Kingdom for funding this work.

References

- Lesser, V.M., J.O. Rawlings, S.E. Spruill, et al., (1990). Ozone effects on agricultural crops – statistical methodologies and estimated dose-response relationships. *Crop Science*, 30:148-155.
- Mills, G., A. Buse, V. Bermejo, et al (2007). A synthesis of AOT40-based response functions and critical levels of ozone for agricultural and horticultural crops. *Atmospheric Environment*, 41:2630-2643.
- Roche, D. (2015). Stomatal Conductance is essential for higher yield potential of C3 crops. *Critical Reviews in Plant Sciences*, 34:429-453.

Simulated wheat yield sensitivity to root biomass partitioning under projected climate

P. Parker – M. Berg – C. Nendel

Landscape Systems Analysis, Leibniz Centre for Agricultural Landscape Research, Eberswalderstr. 84, Müncheberg, Germany 15374, parker@zalf.de

Introduction

Winter wheat is the most important German crop and is subject to considerable climatic risk. Especially drought is a concern at the moment and in foresight to expected future climatic conditions. Weather simulations predict intensified precipitation and temperature patterns in the future, a pattern that can be observed in recent years. Agriculture, the combination of crop genetics and management to alter the growing environment, will adapt. Setting objectives based on credible assumptions should accelerate adaptation and bolster future agricultural productivity. Maintaining wheat productivity in the near future will rely on current technological progress, including genetic advance. This makes the physiology of winter wheat stands in response to projected climate in the next decades a subject of interest to farmers, breeders and landscape research. One tool for preparing adaptation objectives is crop simulation modeling, the contributory value of which depends on its reliability to anticipate the interactions in agroecosystems. Simulated interactions between genetics and managed environments may by now be well-enough developed to be able to accurately predict the development of advantageous crop-plant attributes that are achievable goals for breeders. This work focuses on one aspect of this theme: how will root development in future wheat cultivars affect yields?

Materials and Methods

The crop model MONICA (Nendel et al., 2011) is labeled as “generic” because a parameterization, as opposed to “hard-coded” processes is what differentiates simulated plants. This results in a large set of adjustable parameters that are advantageous as long as sufficient data is available for calibration. With this degree of detail in genotype-specific parameters the model can effectively distinguish between cultivars, both existing and theoretical. Based on this capability, MONICA was used to simulate yield respond to plant physiological attributes by altering the energy distribution between plant organs: roots, stem, leaves and fruit, via organ-specific assimilate partitioning parameters in the model database.

To examine the relationship between root development during the growing season and eventual grain yield, model parameters for maximum rooting depth and the percentage of available assimilates that are allocated to root growth. Simulated root growth was systematically changed from their settings in previous research (Asseng et al., 2014), to examine how root growth ultimately influences yield, absolute and in terms of variability, as respective measures of crop productivity and associated risk.

Partitioning to all organs must sum to 100%, so that increasing root biomass entails reduction elsewhere. Multiple scenarios of wheat genetic adaptation were put forth in the form of increases and decreases in the percentage of total available assimilates allocated to root growth, at the expense of allocation to other organs. This was applied separately during the various stages of crop maturity, which encompass the photothermal duration between physiological shifts in crop growth. Each scenario was run across the arable landscape of Germany, using gridded future weather at 12 km² resolution and soil profiles distinguished at 1:1,000,000 scale. Results examine the response of yield to varied root growth parameters, by geographic region in the country.

Results and Discussion

The sensitivity of simulated yields to root and biomass partitioning shows a range of response within the country. In some areas increased root biomass increases yield and decreases variability, therefore proving to be advantageous to farmers. In other areas, efforts to increase root mass at the expense of other organs are shown to be disadvantageous, by decreasing yields without decreasing yield variability enough to compensate for the loss.

Grain number per head and leaf biomass are the strongest drivers of yield, leaving stem biomass as the preferred source to draw from in increasing root biomass. A shorter, but not thinner shaft is otherwise agronomically desirable as well, by reducing the tendency toward lodging.

Conclusions

This research indicates were crop breeders could focus their attention, based on the goal of providing cultivars more resilient to climate change. Whether the mechanisms in this study, by which organ assimilate partitioning is varied, are achievable through breeding is a topic that must be reconciled with breeders to evaluate the plausibility of proposed scenarios.

References

- Nendel, C., Berg, M., Kersebaum, K. C., Mirschel, W., Specka, X., Wegehenkel, M., K. O. Wenkel & Wieland, R. (2011). The MONICA model: testing predictability for crop growth, soil moisture and nitrogen dynamics. *Ecological Modelling*, 222(9), 1614-1625.
- Martre, P., Wallach, D., Asseng, S., Ewert, F., Jones, J. W., Rötter, R. P., Boote, K. J., Ruane, A. C., Thorburn, P. J., Cammarano, D., Hatfield, J. L., Rosenzweig, C., Aggarwal, P. K., Angulo, C., Basso, B., Bertuzzi, P., Biernath, C., Brisson, N., Challinor, A. J., Doltra, J., Gayler, S., Goldberg, R., Grant, R. F., Heng, L., Hooker, J., Hunt, L. A., Ingwersen, J., Izaurralde, R. C., Kersebaum, K. C., Müller, C., Kumar, S. N., Nendel, C., O'leary, G., Olesen, J. E., Osborne, T. M., Palosuo, T., Priesack, E., Ripoche, D., Semenov, M. A., Shcherbak, I., Steduto, P., Stöckle, C. O., Stratonovitch, P., Streck, T., Supit, I., Tao, F., Travasso, M., Waha, K., White, J. W. and Wolf, J. (2015). Multimodel ensembles of wheat growth: many models are better than one. *Glob Change Biol*, 21: 911-925.

Comparison and validation of three soybean phenology models

H. F. Peltzer¹ – N. G. Peltzer²

¹ EEA Paraná, INTA, Entre Rios Route 11. 12,5 Km. Zipcode 3100, Argentina,
e-mail: peltzer.hugo@inta.gob.ar

² Facultad de Ingeniería y Ciencias Hídricas, Universidad Nacional del Litoral.
e-mail: nelson.peltzer@gmail.com

Introduction

Temperature and photoperiod regulate the duration of soybean development stages. Photothermal sensitivity varies between the genotypes, being higher in long-cycle cultivars compared with short-cycle ones. Temperature and photoperiod also vary according to geographic location (latitude) and time of the year (sowing season), generating a complex genotype-environment interaction. This interaction makes it difficult to predict crop phenological stages. A simulation model to predict the date of occurrence of these phenological stages is very useful for decision-making in crop management. (Boote et al., 1996). In this work, we compared and validated three empirical models for simulating soybean phenology stages. The three models presented in this paper are in commercial phase under the brand SIFESOJA.

Materials and Methods

We built the first model (model A) from a database generated by trials with multiple cultivars (maturation groups III to VIII) and different sowing dates (September to February each year). These trials were conducted for 10 years (2003-2013) on 23 locations in Argentina (24° to 38° Latitude South).

The other two models were similar to the first one, but in this case we replaced cultivar by maturity group, splitting each group in 10 sub-groups (model B) and then in 3 sub-groups: short, medium and large (model C). The 143 cultivars included in the model A were grouped according to maturity group and sub-group and finally we calculated the parameters needed to build the models B and C.

For model validation, we used data of full flower (R2), seed formation (R5), maturity (R7), and full maturity (R8) following Fehr and Caviness scale (1977), obtained on trials from the National Network of Soybean Cultivar Trials (*Red Nacional de Evaluación de Cultivares de Soja*, RECSO 2014/15, Fuentes et al., 2015); the total data observed was 420. We compared these data with simulated results obtained from the three models.

Results and Discussion

The deviations between observed and simulated data were lesser than or equal to 4: i) in the 75.5 % of cases when predictions were obtained from the first model (model A); ii) 61.4 % cases when the model was B; and iii) 64.8 % when we utilized the model C (Table 1). In turn, the average deviation of the 420 cases used for validation was 3.0 days for model A, 4.1 days for model B and 3.7 for model C.

Table 1: Absolut frequency, relative frequency and cumulative frequency of the deviation between observed data and simulated data, with the three models.

Desviación (días)	SIFESOJA A			SIFESOJA B			SIFESOJA C		
	Absolut	Relative (%)	Acumulative	Absolut	Relative (%)	Acumulative	Absolute	Relative (%)	Acumulative
0	54	12.9	12.9	35	8.3	8.3	32	7.6	7.6
1	83	19.8	32.6	61	14.5	22.9	70	16.7	24.3
2	73	17.4	50.0	75	17.9	40.7	73	17.4	41.7
3	55	13.1	63.1	43	10.2	51.0	44	10.5	52.1
4	52	12.4	75.5	44	10.5	61.4	53	12.6	64.8
5	35	8.3	83.8	41	9.8	71.2	53	12.6	77.4
6	31	7.4	91.2	34	8.1	79.3	28	6.7	84.0
7	16	3.8	95.0	31	7.4	86.7	21	5.0	89.0
8	8	1.9	96.9	17	4.0	90.7	20	4.8	93.8
9	6	1.4	98.3	13	3.1	93.8	18	4.3	98.1
10	3	0.7	99.0	10	2.4	96.2	2	0.5	98.6
11	3	0.7	99.8	5	1.2	97.4	4	1.0	99.5
12	1	0.2	100.0	0	0.0	97.4	0	0.0	99.5
13				6	1.4	98.8	0	0.0	99.5
14				2	0.5	99.3	1	0.2	99.8
15				2	0.5	99.8	1	0.2	100.0
16				0	0.0	99.8			
17				1	0.2	100.0			
Total	420			420			420		

A few cultivars had a very different behavior compared to their partner types on the maturation group. These variations explained deviations higher than 12 days on some cases in the models B and C (Table 1).

Conclusions

The replacement of cultivar for the maturity group and sub-group (in model B and C) increased the prediction error. However, model adjustment was reach with a mean deviation of around 4 days. We suggest the use of models B and C, given its low prediction error and independence of cultivar types (something important considering frequent actualizations and continuous emergence of new cultivars), and considering that this model is broadly adopted in all the Argentine soybean cultivation area.

Acknowledgements

To Sonia B. Canavelli and Diego J. Santos, INTA Paraná, Argentina, for their translation from Spanish and useful recommendations.

References

- Boote, K. J., J.W. Jones and N.B. Pickering (1996). Potential Uses and Limitations of Crop Models. *Agronomy Journal* 88:704-716.
- Fehr, W.R. and C.E. Caviness (1977). States of soybean development. Special Report 80. Cooperative Extension Service. *Agriculture and Home Economics*. 11:929-931.
- Fuentes, F.H. et al., (2015). Red Nacional de Evaluación de Cultivares de Soja. Technical Report of Campaign Results 2014/15. Technical Assistant Agreement INTA/ASA.

Uncertainty of crop yield aggregations

*V. Porwollik*¹ – *C. Müller*¹ – *J. Elliott*^{2,3} – *J. Chryssanthacopoulos*³ – *T. Iizumi*⁴ – *D. K. Ray*⁵ – *A. C. Ruane*^{6,2} – *A. Arneeth*⁷ – *J. Balkovič*⁸ – *P. Ciais*⁹ – *D. Deryng*^{10,11} – *C. Folberth*^{8,12} – *R. C. Izaurralde*^{13,14} – *C. D. Jones*¹³ – *N. Khabarov*⁸ – *P. J. Lawrence*¹⁵ – *W. Liu*¹⁶ – *T. A.M. Pugh*⁷ – *A. Reddy*¹³ – *G. Sakurai*¹⁷ – *E. Schmid*¹⁸ – *X. Wang*^{9,19} – *A. de Wit*²⁰ – *X. Wu*⁹

¹ Potsdam Institute for Climate Impact Research, 14473 Potsdam, Germany; Potsdam Institute for Climate Impact Research (PIK), Research Domain II Climate Impacts & Vulnerabilities, Telegraphenberg 31, 14473 Potsdam, Germany; vera.porwollik@pik-potsdam.de

² Columbia University, Center for Climate Systems Research, New York, NY 10025, USA

³ University of Chicago, Computation Institute, Chicago, IL 60637, USA

⁴ National Institute for Agro-Environmental Sciences, Agro-Meteorology Division, Tsukuba, 305-8604, Japan

⁵ University of Minnesota, Institute on the Environment, Saint Paul, Minnesota 55108, USA

⁶ National Aeronautics and Space Administration, Goddard Institute for Space Studies, New York, NY 10025, USA

⁷ Karlsruhe Institute of Technology, IMK-IFU, 82467 Garmisch-Partenkirchen, Germany

⁸ International Institute for Applied Systems Analysis, Ecosystem Services and Management Program, 2361 Laxenburg, Austria

⁹ Institut Pierre Simon Laplace, Laboratoire des Sciences du Climat et l'Environnement, Orme des Merisiers, F-91191 Gif-sur-Yvette, France

¹⁰ Grantham Research Institute on Climate Change & the Environment, London School of Economics and Political Sciences, London, WC2A 2AE, United Kingdom

¹¹ University of East Anglia, School of Environmental Sciences, Climatic Research Unit, Norwich, NR4 7TJ, United Kingdom

¹² Ludwig Maximilian University, Department of Geography, 80333 Munich, Germany

¹³ University of Maryland, Department of Geographical Sciences, College Park, MD 20742, USA

¹⁴ Texas A&M University, Texas AgriLife Research and Extension, Temple, TX 76502, USA

¹⁵ National Center for Atmospheric Research, Earth System Laboratory, Boulder, CO 80307, USA

¹⁶ Swiss Federal Institute of Aquatic Science and Technology, Eawag, CH-8600 Dübendorf, Switzerland

¹⁷ National Institute for Agro-Environmental Sciences, Ecosystem Informatics Division, Tsukuba, JPN

¹⁸ University of Natural Resources and Life Sciences, 1180 Vienna, Austria

¹⁹ Peking University, Sino-French Institute of Earth System Sciences, 100871 Beijing, China

²⁰ Alterra, Wageningen University and Research Centre, Earth Observation and Environmental Informatics, 6708PB Wageningen, Netherlands

Introduction

The aggregation of simulated gridded crop yields requires information on temporal and spatial patterns of crop-specific harvested areas. This analysis estimates the aggregation uncertainty of modeled yields related to different harvested area data sets.

Materials and Methods

We aggregate simulated gridded yields from the Global Gridded Crop Model Intercomparison (GGCMI) (Elliott et al., 2015) as well as from the Intersectoral Impact Model Intercomparison (ISI-MIP) and Agricultural Model Intercomparison and Improvement Project (AgMIP) fast track (Rosenzweig et al., 2014) of four different crops to global, national, and regional scale. We determine aggregation-driven

differences in mean yields and correlation of aggregated time series as measures of spatial and temporal uncertainty.

Results and Discussion

Among the four investigated crops, global wheat yield (17% relative difference) is most affected by the uncertainty introduced by the aggregation with the different masks. The correlation coefficient for global aggregated yield time series is lowest for soybean ($r=0.39$). The spatial and temporal difference can be substantial higher for individual countries, due to differences in harvested area data and the heterogeneity in simulated spatial yield patterns. Of the top-10 crop producers, aggregated multi-annual mean yield can differ by up to 37% (maize, South Africa), 40% (wheat, Canada), 42% (rice, Japan), and 68% (soybean, Bolivia) when considering the different harvested area data sets. Yet for the majority of countries, relative differences of mean yields account for 10% or less. Among the top-10 producers correlations between the differently aggregated national yield time series can be as low as $r=0.56$ (maize, India), $r=0.15$ (wheat, Russia), $r=0.13$ (rice, Viet Nam), and $r=-0.07$ (soybean, India). The aggregation to regional scale in comparison to country scale shows that the combined effect of modeled crop yields and harvested area mask can level out in countries with large harvested areas per crop.

Conclusions

The uncertainty of simulated yields related to aggregation masks is determined by the convolution of two factors: a) the differences in spatial patterns of crop-specific harvested area of the four investigated data sets and b) the spatial distribution and heterogeneity of simulated crop yields, which is specific to individual Global Gridded Crop Models (GGCMs). With this analysis we conclude that the aggregation uncertainty can have implications for crop model validation procedures and country scale production estimations in context of food security and climate impact assessments.

Acknowledgements

Special thanks to all data contributors to the crop model simulations of the Inter-Sectoral Impact Model Intercomparison Project (ISI-MIP). V.P. and C.M. acknowledge financial support from the MACMIT project (01LN1317A) funded through the German Federal Ministry of Education and Research (BMBF).

References

- Elliott, J., C. Müller, D. Deryng et al., (2015). The global gridded crop model intercomparison: Data and modeling protocols for phase 1 (v1.0). *Geoscientific Model Development* 8(2), 261-277.
- Rosenzweig, C., J. Elliott, D. Deryng et al., (2014). Assessing agricultural risks of climate change in the 21st century in a global gridded crop model intercomparison. *Proceedings of the National Academy of Sciences* 111(9), 3268-3273.

CROPGRO-Tomato model for simulated growth parameters of field-grown tomato in the Elbe lowland conditions

V. Potopová – L. Turkott – D. Hiřmanová

Department of Agroecology and Biometeorology, Czech University of Life Sciences Prague, Kamýcká 129, Praha-6 Suchbátka 165 21, Czech Republic, potop@af.czu.cz

Introduction

There are a number of crop growth models for tomato of which some are adapted for greenhouse production and others for field production systems. CROPGRO-Tomato model was adopted by Scholberg et al., (1997) to simulate field-grown tomato. Boote et al., (2012) created a module for predicting fresh tomato weight and fruit size, which was added to the Decision Support System for Agrotechnology Transfer (DSSAT) software. They also modified cardinal temperatures in this model to predict more accurately tomato growth and yield response to temperature (i.e. how temperature affects both vegetative and reproductive development, photosynthesis, fruit set and individual fruit growth rate). The aim of this contribution is to analyse the ability of the CROPGRO-Tomato model to simulate the time-series of LAI, leaf growth and total biomass of tomato (*Solanum lycopersicum* L.) from transplanting to technical harvest in condition of the Czech Republic (Elbe lowland).

Materials and Methods

Field datasets were used for the CROPGRO-Tomato model evaluation, which is part of the DSSAT V4.5 software (Hoogenboom et al., 2010). We applied the newly calibrated values of genetic crop and cultivar coefficients for version 4.5 of CROPGRO-Tomato model (Boote et al., 2012). This model simulates development based on multiple phases from emergence to harvest. Parameters affecting leaf growth, dry biomass productions, and dry biomass of leaves, stem and generative organs from planting to harvest were calibrated against the measured data. The measured and simulated growth and development of the fresh-market Thomas F1 tomato bush cultivar grown under open field conditions in two different sol-climate locations in the Elbe lowland were evaluated. The treatments selected for evaluation were well-irrigated and well-fertilised, and therefore, no water or N stress from 2014 to 2015 was present. The sampling plants were collected a once 14 days for analysis of basic physiological parameters: LAI (Leaf area index), LAR (Leaf Area Ratio), C (Crop Growth Rate), RGRw (Relative Growth Rate) and NAR (Net Assimilation Rate). To run CROPGRO model, we used the following 4 basic dataset groups: (1) crop species and cultivar characteristics; (2) meteorological daily data: rainfall (mm), solar radiation ($\text{MJm}^{-2}\text{d}^{-1}$), maximum and minimum air temperatures ($^{\circ}\text{C}$); (3) soil conditions and (4) cultivation technology. (term of transplanting, term and dose of irrigation, fertilizing, harvesting).

Results and Discussion

The weather conditions in the Elbe lowland during the growing seasons of 2014 and 2015 produced an extreme drought and heat stress. Moreover, the developmental stage of a vegetative unit at which the leaves are removed influenced LAI strongly and therefore crop growth rate. Early leaf pruning decreased LAI as well as biomass. Overall, the ability of the CROPGRO-Tomato model to simulate the time-series of LAI for Thomas cultivar was relatively satisfactorily (Fig. 1, Table 1).

Table 1. Root mean square error (RMSE) and Willmott d index for time series simulations as compared with measured values

Experiment	Leaf area index		Aboveground biomass	
	RMSE	Willmot	RMSE	Willmot
Praha-Suchdol 2014	0.41	0.78	298	0.89
Praha-Suchdol 2015	0.65	0.82	382	0.92
Mochov 2014	0.82	0.96	330	0.99
Mochov 2015	0.88	0.98	473	0.95
Average	0.69	0.89	371	0.94

Nevertheless, there were some weaknesses in LAI prediction: in several experiments, the LAI was overestimated, and in other experiments, the LAI was underestimated. As mentioned Boote et al., (2012), it is difficult to obtain LAI simulations that satisfy the observations for all experiments.

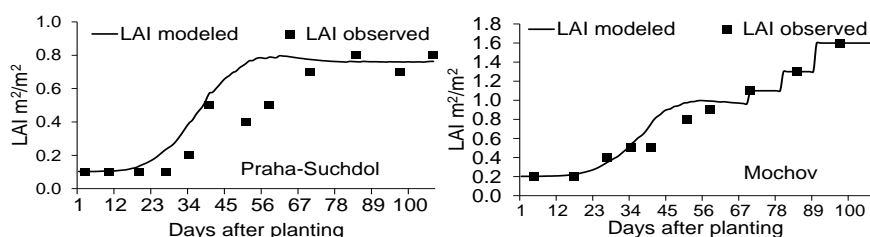

Figure 1. The comparison of the simulated LAI with measured values at Mochov and Suchdol during 2014.

Conclusions

Because the comparisons were made using time-series data, the Willmott d index provided well indication of model performance. Overall, the d index was higher for total dry biomass (0.94) and LAI (0.89).

Acknowledgements

Institutional Support Program for Long Term Conceptual Development of Research Institution provided by Ministry of Education, Youth and Sports of the CR.

References

- Boote, K.J., Rybak, M. R., Jones, J.W. (2012). Improving the CROPGRO-Tomato model for predicting growth and yield response to temperature. *HortScience*, 47(8):1038–1049.
- Hoogenboom, G., Jones J.W., Wilkens, et al., (2010). Decision Support System for Agrotechnology Transfer (DSSAT) Version 4.5 [CD-ROM]. University of Hawaii, Honolulu, Hawaii.
- Scholberg, J. M. S. et al., (1997). Adaptation of the CROPGRO model to simulate the growth of field-grown tomato, p. 133–151. In: Systems approaches for sustainable agricultural development: Applications of systems approaches at the field level. Kluwer, Dordrecht, The Netherlands.

Adapting the CSM-CROPGRO-Canola model for spring canola in eastern canada

B. Qian^{1*} – *J. Shang*¹ – *Q. Jing*¹ – *G. Hoogenboom*² – *T. Huffman*¹ – *J. Liu*¹ – *B.-L. Ma*¹
– *X. Geng*¹ – *X. Jiao*³ – *J. Kovacs*³ – *D. Walters*³

¹ Eastern Cereal and Oilseed Research Centre, Agriculture and Agri-Food Canada, Ottawa, ON K1A 0C6, Canada, e-mail: Budong.Qian@agr.gc.ca

² AgWeatherNet Program, Washington State University, Prosser, Washington 99350-8694, USA

³ Department of Geography, Nipissing University, North Bay, ON P1B 8L7, Canada

Introduction

Canola was developed in Canada in the 1970s as an edible cultivar of rapeseed (*Brassica napus* L.) with low glucosinolates and low erucic acid. A model adaptation for winter canola under the Mediterranean conditions was conducted by Deligios et al., (2013) and the adapted mode has been integrated into DSSAT Version 4.6 (Hoogenboom et al., 2014) as CSM-CROPGRO-Canola. This model has been evaluated for irrigated conditions, but so far has not been evaluated for rainfed and N stress conditions. The objective of this study was to adapt the CSM-CROPGRO-Canola model for simulation of canola growth and yield in Canada with different N treatments under rainfed conditions.

Materials and Methods

Field experiments. Five field experiments were conducted in West Nipissing, Ontario, Canada (46°22'N, 80°5'W) from 2012 to 2014. The experiments consisted of different N strategies including various rates from 0 to 200 kg ha⁻¹ and application splits under rainfed conditions. The measured data include phenology, plant area index (PAI), leaf area index (LAI), shoot/aboveground biomass, leaf and grain nitrogen content, soil moisture.

Model evaluation. The crop parameters for canola from Deligios et al., (2013) were set as default values and were then calibrated with the experimental data. The crop and soil data from two independent experiments were used to calibrate the model and the rest for model validation.

Results and Discussion

The calibrated crop parameters are shown in Table 1 in comparison with the default values from Deligios et al., (2013). The simulated LAI followed the pattern of measured PAI rather than the measured LAI (Fig. 1). This can be explained by the special biophysical feature of the canola crop that green pods take over fading green leaves for photosynthesis before crop maturity. In the current CSM-CROPGRO-Canola model the functions for light interception and photosynthesis of pods were emulated by combining pods with leaves into a synthetic LAI. Therefore, overestimations of LAI in the late growing season were actually required to mimic the function of pods for light

interception and photosynthesis in the late growing phase. The aboveground biomass was well simulated as the simulated values were close to measured ones (Figure 1). The model also adequately simulated soil moisture contents during the whole growing season and soil inorganic N content under different N treatments (data not shown).

Table 1. Crop parameters (species) and their definitions with default and calibrated values.

Parameter	Definition	Default†	Calibrated
PROLFG	Leaf protein content (g g^{-1})	0.210	0.243
PCARLF	Leaf carbohydrate content (g g^{-1})	0.620	0.500
PCARST	Stem carbohydrate content (g g^{-1})	0.640	0.590
XSLATM	Critical temperatures of temperature stress curve on specific leaf area of new leaves ($^{\circ}\text{C}$)	0, 6, 15, 60	0, 6, 17, 60

† The values from Deligios et al., (2013).

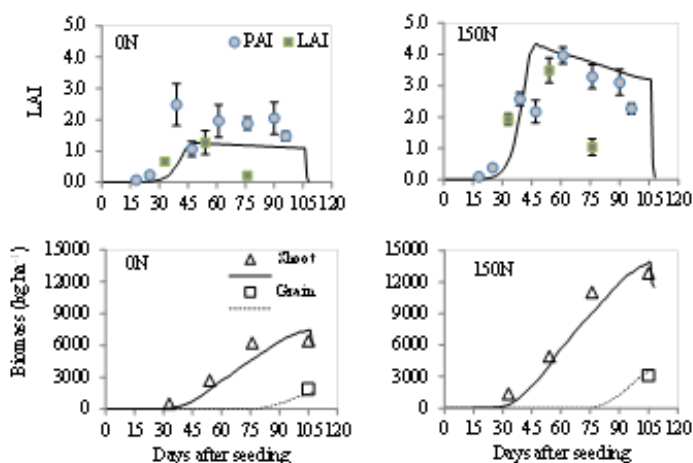

Figure 1. Simulated leaf area index (LAI, line) versus measured values (symbols) of plant area index (PAI, filled circle) and LAIs (filled square), and simulated versus measured aboveground biomass and grain yield (dry matter) of Canola under different N fertilizer rates (ON – 0 kg N ha⁻¹, 150N – 150 kg N ha⁻¹) in 2013. Whiskers on symbols are standard deviations of the measured values.

Conclusions

The model successfully mimicked the characteristics of canola for light absorption and utilization using combinations of leaf and pods during seed filling. The accumulations of aboveground biomass were well simulated in the life cycle of canola under different N rates. The seed yields were also successfully predicted for various N applications. Satisfactory simulation of soil processes showed a good adaptation of the CSM-CROPGRO-Canola model for spring canola in Canada. Meanwhile, the adaptation did not significantly change the simulations of winter canola grown in the Mediterranean environment that was originally adapted into DSSAT v4.6.

References

- Deligios, P. A., R. Farci, L. Sulas et al., (2013) *Field Crops Research*, 144: 100-112.
 Hoogenboom, G., J. W. Jones, P.W. Wilkens et al., (2014) *Decision Support System For Agrotechnology Transfer (DSSAT)*. Version 4.6 (WWW.DSSAT.net). DSSAT Foundation, Prosser, Washington, USA.

Analysis of crop yield variability and yield gaps for maize and wheat in diverse climatic zones

*R. P. Rötter*¹ – *J. Höhn*¹ – *B. T. Kassie*² – *K. Paff*² – *T. Palosuo*¹ – *C. Yi*^{3,1} – *F. Tao*¹ – *F. Ewert*⁴ – *S. Asseng*² – *Haakana*¹

¹ Environmental Impacts Group, Natural Resources Institute (Luke), 01301 Vantaa, Finland

² Agricultural and Biological Engineering Department, University of Florida, Gainesville, FL, 32611, USA

³ Academy of Disaster Reduction and Management, Beijing Normal University, Beijing 100875, China

⁴ Institute of Crop Science and Resource Conservation INRES, University of Bonn, 53115, Germany

Introduction

At global scale, demand for agricultural products will likely double by 2050. Future food security will, among others, be co-determined by changes in demand, climate and agro-technologies. The quest for sustainable intensification of food production systems has triggered research on determining and closing the “yield gap” between farmers’ actual yields and the potential crop yields attainable under best management. While this yield gap indicates Evaluating, *ex ante* the scope of technological innovations to close this gap and counteract stagnating yields also requires information on yield variability to account for climate-induced risks. Here, we present such analyses for two crop systems from boreal to tropical climatic zones.

Materials and Methods

Study focus is on wheat and maize at six sites and their surrounding regions in China, Ethiopia, Finland and USA under current (1981-2010) and possible future climates. The methodology combines crop modelling and statistical analysis. Specific steps in our approach include: (i) assessing actual crop yields and variability at field/farm and regional level under different management conditions, (ii) crop growth simulation to assess crop yield potentials and their variability for quantifying yield gaps and yield reliability for different and changing environmental conditions - using multiple crop models (DSSAT, MCWLA, WOFOST), and (iii) model-aided evaluation of improved or new agro-technologies that would close yield gaps and reduce yield variability under a changing climate. We applied crop models that had been calibrated at the given sites during previous studies (e.g. Kassie et al., 2014; Tao et al., 2012).

Results and Discussion

In this paper we present selected results for step 1 of the study, comprising two sites in the Central Rift Valley of Ethiopia, one site in SW Finland, one in the North China plain and two sites in the Midwest (Iowa and Kansas) of the USA. Production situations included average farmers’ practice from regional yield statistics (Y_a), best management practice by represented trial site yields (Y_b), simulated water-limited yields (Y_w) and simulated potential yields (Y_p). Yield levels (mean, median) and variability (here: $\pm 1 \sigma$) for the two crops varied considerably among the sites, so do the production risks and

yield gaps (Fig. 1). The mean relative yield gap for wheat, for example, was as large as 79% at the Ethiopian location and amounted to 44% at the Finnish site. Large differences in interannual yield variability also exist among the production situations

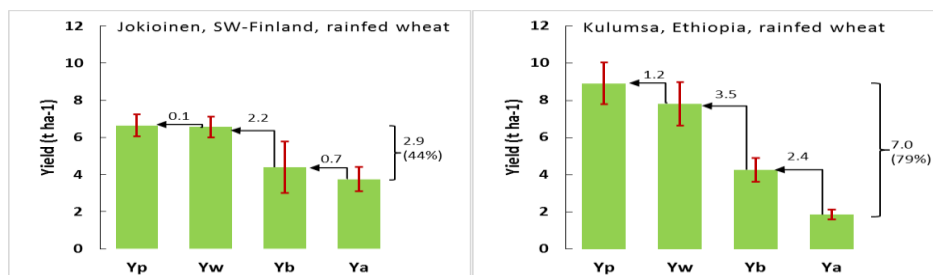

Figure 1. Yield gaps for wheat in the different production situations for the Ethiopian and Finnish site. Error bars represent $\pm 1 \sigma$ (standard deviation).

as indicated by various statistical measures (IQR/ Median, σ and CV) (not shown). Highest yield variability can be found for wheat in Yw (simulated water-limited yields at Hays/Kansas in the USA (CV = 46%)) and for maize in Yb (trial site yield representing best practices in China (CV = 34%)). As farmers have different risk attitudes which influence their investment in technological innovations, we defined a so-called 'normal management mode' derived from common farming practice for each environment. Applying this mode we can show how future yields and yield variability are likely to change, and illustrate to what extent improved or new technologies (such as improved soil fertility management or new climate resilient crop genotypes) can increase yields and reduce production risks.

Conclusions

Our findings, also supported by previous studies, suggest that under current management practices frost, drought, heat and other adverse weather events can lead to extreme yield losses in wheat and maize. This study demonstrates the importance of accurately characterizing both, yield gaps and yield variability using an ensemble of crop models in conjunction with observed yield series to provide decision support on investments in technological innovations. This applies even more so under uncertain future climatic conditions. Such quantitative analysis at multiple scales can provide a sound basis for indicating which future technological innovations have the potential to maintain or increase crop yields at acceptable risk levels.

Acknowledgements

This work received support and was jointly conducted by projects FACCE-MACSUR and AgMIP.

References

- Kassie, B.T., van Ittersum, M.K., Asseng, S. et al., (2014). *Field Crops Research* 25:365-371
 Tao, F. Zhang, Z., Zhang, S. et al., (2012) *Climate Res.*, 54: 233-247.

Delimiting the validity domain of a crop model with uncertainty analysis: the case of a vineyard model with a run-off module

*S. Roux*¹ – *J. Wery*²

¹ INRA - UMR System, 2 place Pierre Viala, 34060 Montpellier, France, rouxs@supagro.inra.fr

² SupAgro - UMR System, 2 place Pierre Viala, 34060 Montpellier, France,

Introduction

Many crop models, for instance APSIM, Aquacrop, CropSyst, DSSAT, EPIC, use a run-off module based on the “curve number (CN) method” as described in the USDA National Engineering Handbook. This method is easy to integrate into daily-time step crop models but lacks precision as it only considers daily rainfall intensity and empirically adapts the rainfall run-off ratio to soil surface conditions (Young and Carleton, 2006). This lack of precision can be a major concern when simulating crops having a significant bare soil proportion (as vineyards or orchards) under stormy rainfall regimes, as in Mediterranean climate. This uncertainty source may also be present with future climatic conditions characterized by more frequent stormy rainfall events. In this work, we introduce a simple method to detect when the uncertainty coming from the CN method propagates significantly in a model output. This procedure is applied to a vineyard crop model and allows the identification of model parameter values leading to high (or low) uncertainty.

Materials and Methods

Our case study is a vineyard water balance model (Gaudin et al., 2010) used for estimating the dynamics of vineyards water stress. The model performs a water balance with a single tipping bucket approach and includes a CN run-off module. The main model output is the fraction of transpirable soil water (FTSW), which is deduced from the soil humidity using the total transpirable soil water parameter (TTSW). Our procedure to detect the uncertainty is based on the random variable interpretation of the CN parameter, which states that only the range of the CN parameter, [CNI, CNIII], is reliable and that for each separate rainfall event, the correct CN value is a random variable within this range. This hypothesis has been used in (Young and Carleton, 2006) to build a run-off stochastic model. Our approach consists in extracting the reliable range of CN values in order to build the uncertainty range on the model output. This method only needs two simulations: one with CN=CNI, one with CN=CNIII (both for all rainfall events). The method requires that the model is monotonic with respect to the CN values, which is verified with the vineyard model. We also performed a numerical experiment on a climatic sequence of 42 years (Montpellier, France) in order to analyze the response of the FTSW uncertainty when soil parameters (TTSW and CN) vary. For each 42-year long simulation, we counted how many years the uncertainty in FTSW, measured with the mean uncertainty over the vineyard season (april-october),

is greater than a threshold (we took 0.2, which is the order of magnitude of this vineyard model error (Roux et al, 2014)).

Results and Discussion

The propagation of uncertainty using our procedure can be seen on the right side of Figure 1. The uncertainty propagates differently depending on the parameter setting and has a complex dynamic structure. However, the detection of uncertainty in the parameter space using the long climatic sequence reveals that the region with low CN (high infiltration) and low TTSW (small water stock) has a low occurrence of uncertainty (point B), while the region with high CN (low infiltration) and high TTSW (big water stock) appears very sensitive to run-off uncertainty (point A). The run-off uncertainty model, as every model, has some limits, such as the empirical determination of CN_I and CN_{III} from the central CN value, but the strong tendency shown in the parameter space can be used to apply the model more safely. These results apply mainly when using the model on pluri-annual climatic sequences. They should be completed by uncertainty evaluations when the water stock at vineyard budburst is known.

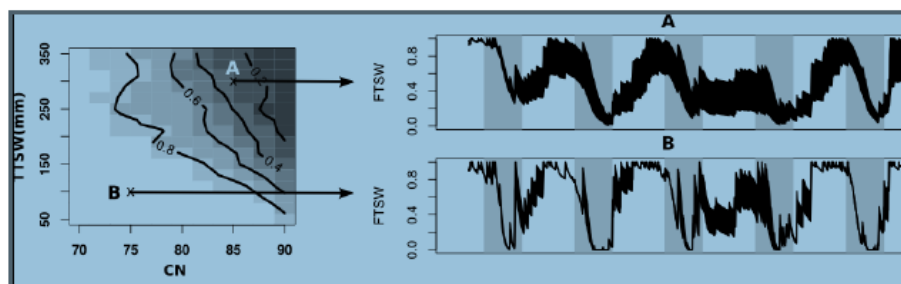

Figure 1. illustration of the propagated uncertainty in the parameter space (parameter CN and TTSW) on the left with two examples on the right side of detailed uncertainty curves plotted over the first 5 years. Gray levels on the left part represent the reliability index of the model output, with low reliability for darker areas.

Conclusions

We have proposed a method to detect the uncertainty associated with the use of the curve number method in crop models. The method allows detecting situations where the uncertainty level may be high. This information may be useful for model users and model developers for instance to guide model improvement in coherence with model use.

References

- Gaudin, R., Celette, F. and Gary, C. (2010). *Agricultural Water Management*, 97(10), 1534–1540.
- Roux, S., Brun, F. And Wallach, D. (2014). *European Journal of Agronomy*, 52, 191–197.
- Young, D. F. and Carleton, J. N. (2006). *Environmental Modelling & Software*, 21(8), 1172–1179.

Parametrization of crop model using a regional agronomical database: rice in camargue with STICS

*F. Ruget*¹ – *S. Buis*¹ – *K. Irfan*¹ – *S. Delmotte*² – *J.-C. Mouret*² – *S. Lopez Ridaura*² –
*F. Trolard*¹

¹ INRA UMR 1114 EMMAH 28 Route de l'Aérodrome 84914 AVIGNON Cedex 9, France, ruget@paca.inra.fr

² INRA UMR 0951 INNOVATION Campus SupAgro, 2 place Viala 34060 MONTPELLIER Cedex 2, FRANCE

Introduction

The adaptation of a generic crop model, like STICS, to a new crop is generally done using data coming from a few experiments with a large number of variables measured several times during the plant cycle (Flénet et al., 2004, Confalonieri et al., 2009, Coucheney et al., 2015). The adaptation of STICS for rice, presented hereafter, was done using a large dataset containing soil permanent characteristics, accurate description of practices, plant phenology and plant measurements done only at harvest for most of the fields. The aim of this paper is to assess the quality of the model simulations done with parameters estimated from a database with a high number of basic measurements.

Materials and Methods

The database contains agronomical observations, collected along a 25 years period (1984-2009) in fields (471 fields) spread in the whole Camargue region. According to DataRanker, a tool built up to classify data (Kersebaum et al., 2015), the quality of this database is "copper", that is the least good of all the defined classes. Consequently, the richness of this database can't come from the accuracy of the observations.

A selection of plots was done, to avoid cases for which the factors affecting yield are not depicted in the model, using on one hand the CART analysis of Delmotte et al., (2011), leading to discard fields with weeds or salty soils, on the other hand an agronomical analysis of yield components. Moreover, fields lacking of information on plant phenology or soil properties were eliminated too. More than three quarter of the fields were discarded, mainly because of the presence of weeds. The resulting database (124 fields) was split into calibration and validation sets.

Parameters values were chosen according to classical methods (Flénet et al., 2004), and those without suitable values from analogy to other plants, literature or direct measurements were optimized, using the OptimiSTICS tool (Buis et al., 2011).

Results and Discussion

Even after this severe selection of fields, the overall quality of the simulations is not excellent, the rRMSE stays near 20 % for the main variables: biomass and yield).

However, 3 main observations can be done from the comparison of simulated and observed values. Firstly, the effect of the main sources of yield variation –climate of

year, soil, variety and fertilization- is observed when the average yield of plots grouped by levels of factors, it is simulated in a satisfactory way (not shown), except for fertilizations where the model underestimates the low values and overestimates the highest ones. Secondly, when initial soil nitrogen is known, r^2 increases from 0.12 to 0.28), the quality of the simulations is better, which means that quality increases according to the accuracy of input data. Thirdly, using the model as a tool taking into account the most known factors of yield variations, it is possible (figure 1a) to identify a new limiting factor, the sandy soil, to find lower boundary for salinity and to show shortcomings of the model, such as the decomposition of rice buried residues. This proves that there are limiting or improving factors not well taken into account. The use of this rice parametrization on the whole database (figure 1b) gives results in accordance with the expectations, right estimation for calibration, evaluation and additional varieties with known phenology, overestimation when limiting factors are not considered (e.g. weeds), underestimation for crops with high density.

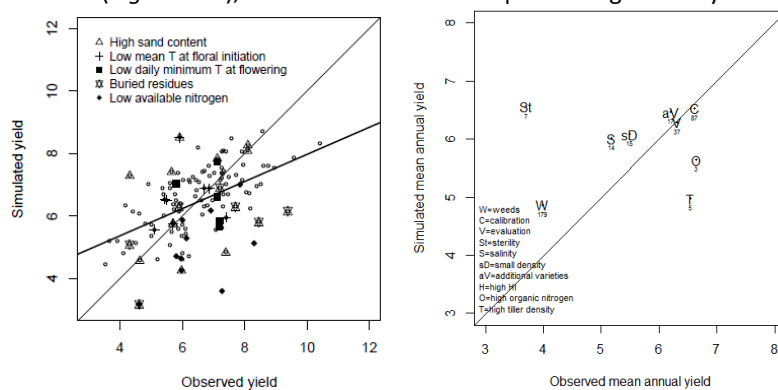

Figure 1. Simulated versus observed yields. a. Individual fields results, with identification of additional limiting factors. b. Average yield for each class of fields (358 fields). Legend: St sterility, W weeds, S salinity, sD small measured plant density, C calibration, V validation, aV additional varieties (similar to known varieties), H high measured harvest index, O high measured soil organic nitrogen, T high measured tiller density. Numbers are the numbers of fields per class.

Conclusions

Even if the parametrization was obtained with data mainly measured at harvest, the model is able to reproduce satisfactorily the main factors of yield variation. The richness of the dataset comes from its original variability, *i.e.* year, practices and soils.

References

- Confalonieri, R., A.S. Rosenmund, B. Baruth (2009). *Agronomy for Sustainable Development*, 29: 463–474.
- Coucheny E., S. Buis, M. Launay et al., (2015). *Environmental Modelling and Software*, 64, 177-190.,
- Buis, S., D. Wallach, S., Guillaume et al., (2011) In: Ma, L.R.A.a.L. (Ed.),. *Advances in Agricultural Systems Modeling*, ASA, CSA and SSSA, Madison, pp. 395-426
- Delmotte, S., P. Tittone, J.-C. Mouret et al., (2011). *European Journal of Agronomy*, 35, 223-236.
- Flénet, F., P. Villon, F. Ruget (2004). *Agronomie*, 24, 367-381.
- Kersebaum, K.C., K.J. Boote, J.S. Jorgenson et al., (2015). *Environmental Modelling and Software*, 72, 402-417.

Regional variability of the climate change effect on grassland production

*F. Ruget*¹ – *D. Ripoche*² – *A.-I. Graux*³ – *J.-L. Durand*⁴

¹ UMR 1114 EMMAH, INRA, 84914 AVIGNON Cedex 9, France, ruget@avignon.inra.fr

² UMR 1116 AgroClim, INRA, 84914 AVIGNON Cedex 9, France

³ UMR 1348 PEGASE, Domaine de la Prise, 35590 Saint-Gilles, France

⁴ UR P3F, 8660 Lusignan, France

Introduction

Even if all the GCM don't give exactly the same intensity of climate change, climate change is known to be highly variable among countries and even among regions (IPCC, 2013). In France, the future of the southern part seems to be very different from this of the northern part. The aim of this paper is to show the expected yield evolutions and their differences between regions, using future climate series and crop models.

Materials and Methods

The grassland yields were calculated inside 2 main scientific projects (ACTA_CC (Ruget et al., 2010) and Climator (Brisson et al., 2010)), using the outputs of the one circulation model, ARPEGE from Météo-France, 2 grassland models (STICS and Pasim), 3 SRES scenarios (B1 and A2 in ACTA-CC, A1B in Climator), 2 time frames (N near, 2020-2050 and D distant, 2070-2100). The cutting practices are similar (4 cuts during the year), without irrigation (as currently managed in grasslands). A MFA on spatial data was done on the meteorological present (1980-2006) data for 235 fictive stations (Ruget et al., 2010), in order to reach a climate description, allowing to gathering of 34 stations into 8 main climatic regions.

In the crop models, the CO₂ concentration affects stomatal conductance, increasing RUE and decreasing transpiration. The outputs used are the annual yield, expressed as relative variation of yield.

Results and Discussion

Whatever the region, the yield is decreasing when not taking into account the CO₂ effect (Table 1), while when taking it into account, the yield increases in most of the regions, except one (in the West). The following estimations are made considering CO₂.

Table 1. Relative variation of grassland yield as function of CO₂ effect (ACTA-CC, STICS, SRES A2, time frame D distant, zone names: 1 mountain foots, 3 North-East, 5 and 7 North-West, 6 Mediterranean region, 8 West).

Regions	1	3	5	6	7	8
With CO ₂	0.084	0.019	0.065	0.056	-0.037	-0.053
Without CO ₂	-0.178	-0.233	-0.227	-0.186	-0.275	-0.278

In the near future (A2N, A1BN), the yield is increasing, whatever the region (Figure 1). Between time frames, results are slightly different: in most of the stations, the yield in the distant future is decreasing when compared to the near future, except for the

Climator STICS exercise. Differences can be explained partly from the differences of climate evolution: (Climator uses A1B, less warm than A2, and increased radiation) and partly by management practices (higher fertilization in Climator).

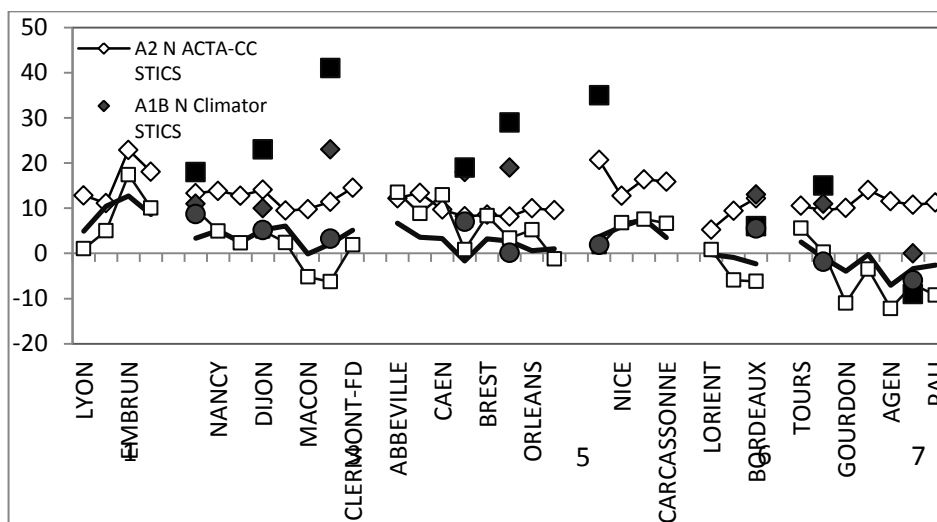

Figure 1. Variability of grassland yield among stations, gathered among climatic zones. Legend: 1 mountain foofs, 3 North-East, 5 and 7 North-West, 6 Mediterranean region, 8 West, A2, B1, A1B, 3 SRES scenarios, N near, D distant: time frame in the future, ACTA-CC/ Climator, projects, STICS/Pasim, grassland models.

Conclusions

Even if most of the grassland yields increase in the near future for all the models, the evolution is variable among models in the distant future, except in the West region (8) where yields are decreasing in all the exercises, in the distant future. An analysis of climate (not shown here) shows that it is the region with highest temperature increase and rin decrease. A similar work is on-going on the French dairy systems in the future, using the new outputs from GCMs.

Acknowledgements

The ACTA-CC work was founded by ACTA_MIRES founding and the Climator project by a French ANR

References

- Brisson, N., F. Levrault (2010) Livre vert du projet Climator, ADEME Ed., 334pp.
- IPCC, (2013): Summary for Policymakers. In: Climate Change 2013. Cambridge University Press, Cambridge, United Kingdom and New York, NY, USA, 28 pp.
- Ruget, F., J.-C. Moreau, M. Ferrand et al., (2010). Adv. Sci. Res., 4, 99–104.

Challenges of modeling climate change impact on smallholder agricultural systems in Africa

L. Rusinamhodzi¹ – M. Corbeel¹ – D. Berre¹ – S. Lopez-Ridaura²

¹ CIMMYT, P.O Box 1041 Village Market 00621 Nairobi, Kenya

² CIMMYT, km 45 Carretera Mexico-Veracruz, El Batán, 56130 Méx., Mexico

¹ rusinamhodzi@cgiar.org

Introduction

Simulation modeling tools have been deployed in several situations in sub-Saharan Africa for *ex-ante* impact analyses of an array of improved crop production systems and can help answer most of the what-if questions (Jones et al., 2003). Climatic volatility especially rainfall is a major barrier confronting small scale farmers in the region, and Africa is projected to be affected more by the devastating effects of climate change on food production (e.g. Challinor et al., 2007). Conservation agriculture (CA) based on soil mulch, no-tillage and crop rotations has been suggested as a possible solution (Wall, 2007). The objective of this paper is to illustrate the challenges of modeling the *ex-ante* impact of climate change on two cropping systems: (a) conventional tillage (baseline), and (b) CA, promoted as a suitable sustainable intensification option for smallholder farmers in the region.

Materials and Methods

Future climatic data and farm typologies from a case study site in Monze, Zambia were used to explore the trajectories of current and alternative cropping systems. The Agricultural Production Systems Simulator (APSIM), version 7.6 (Keating et al., 2003) was parameterised and used to simulate the productivity of maize under conventional and CA options with different scenarios of future climate change generated using an ensemble of 17 global circulation models (GCMs). The management scenarios were derived from different farm typologies created by classifying farmers based on resource ownership and production orientation. Two extreme emission scenarios were considered: (a) the low emission scenario - Representative Concentration Pathway (RCP2.6), and (b) the high emission scenario - Representative Concentration Pathway (RCP8.5). The weather files for the period 2015 to 2050 were generated using MarkSim.

Results and Discussion

Future (year 2050) climate for Monze showed no significant change in solar radiation, but higher total season rainfall compared with current climatic conditions. There was an increase in both minimum (+1°C) and maximum (+1.5 °C) temperatures for the two emission scenarios. However, the ensemble of models showed high variability indicating an uncertainty in future climate prediction. Simulated crop yield results

showed that the advantage of CA in the future would be for the low emission scenario only (Figure 1). This is because of the moisture conservation effects of crop residues retention. This result agrees with some studies (Boko et al., 2007), which have pointed to variable future conditions thus indicating high uncertainty on the GCM predictions for Africa.

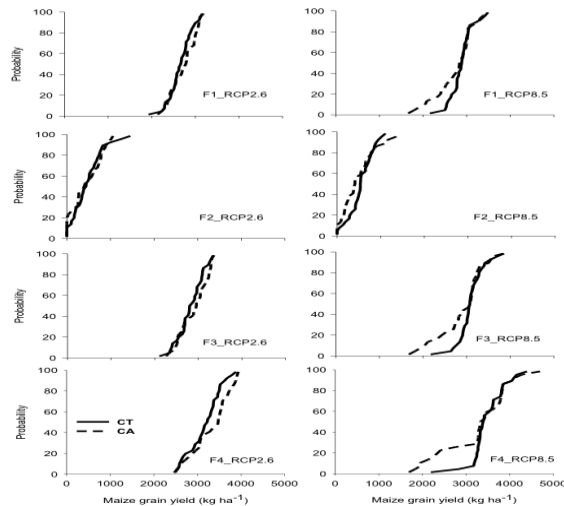

Figure 1. Maize yield probability distribution for conventional tillage (CT) and conservation agriculture (CA) with projected future climate (RCP2.6 and RCP8.5) for the four farm types (F1-F4).

Conclusions

Climate variability is large in Africa even over very short distances thus future climate cannot be predicted with good certainty. There is need to improve the usefulness of climate change modeling in Africa by: (a) having access to high throughput data, (b) locally developed and well-calibrated process-based simulation models, (c) having greater confidence in the selection of GCMs, and (d) having the ability to set relevant emission scenarios.

Acknowledgements

We thank Dr. Christain Thierfelder for providing data from the long-term trial at Monze, Zambia. Financial support from CCAFS through the CGIAR-CRP Twin Post-Doc Program is greatly appreciated.

References

- Boko, M., I. Niang, A. Nyong et al., (2007). In: Parry M.L., O.F. Canziani, J.P. Palutikof et al., Climate Change Cambridge University Press, Cambridge UK, 433-467.
- Challinor, A., T. Wheeler, C. Garfort et al., (2007) Climatic Change 83, 381-399.
- Giller, K.E., P. Tittonell, M.C. Rufino et al., (2011) Agricultural Systems, 104: 191-203
- Jones, J.W., G. Hoogenboom, C.H. Porter et al., (2003) European Journal of Agronomy 18, 235-265
- Keating, B.A., P.S. Carberry, G.L. Hammer et al (2003) European Journal of Agronomy 18, 267-288.
- van Wijk, M.T, P. Tittonell, M.C. Rufino et al (2009) Agricultural Systems, 102: 89-101

Heat waves during number of grain determination reduce yield in different cultivars of durum wheat

*G. de Sanctis*¹ – *A. Toreti*¹ – *A. Belocchi*² – *F. Quaranta*²

¹ European Commission, Joint Research Centre, Ispra, Italy, giacomo.de-sanctis@jrc.ec.europa.eu

² Council for Agricultural Research and Economics, Research Unit for Cereal Quality (CREA-QCE), Italy

Introduction

Wheat can be affected by heat stress at different phenological stages, but this stress is particularly harmful during the reproductive phase due to the direct effect on grain number determination and grain weight (Eyshi Rezaei et al., 2015). However, critical temperature thresholds and sensitivities vary between cultivars (Porter and Gawith, 1999), thus the impacts of high temperatures on wheat yields are complex and diverse. For this reason, there is a clear need to investigate the sensitivity of crop yields to heat stress under field conditions, as well as the role of cultivar changes in the improvement of heat tolerance (Siebert et al., 2014). Durum wheat is more tolerant to heat stress when compared with soft wheat. Nevertheless, the regions where durum wheat is mainly grown are frequently exposed to heat waves (e.g., southern Europe; Fontana et al., 2015). In the last decade new durum wheat cultivars (cv. Simeto, Duilio and Svevo), characterised by high productivity index (Arduini et al., 2006), have been regularly introduced in Italy, decreasing the weight of older cultivars such as cv. Creso. However, the sensitivity of more recent cultivars to heat stress is not yet well known. The objective of this study is to analyse the heat waves impact and the variability of production among years on different cultivars of durum wheat and to discuss how this dataset can be efficiently applied to improve and support crop modeling linkage to genetics.

Materials and Methods

The JRC-MARS meteorological database interpolated on a regular 25x25 km grid is used in this study to analyse heat waves occurred during the number of grain determination period in different cultivars of durum wheat in Italy. Daily maximum temperature time series, covering the period 1997–2011, have been extracted from selected grid cells that include the experimental sites considered for this study. The intensity of heat waves is calculated as the sum of days, having daily maximum temperature above the 95th percentile, occurred during the interval of time relevant for the number of grain determination (from 5 days before heading to 15 days after the headings observed in the field).

Crop data time series from 1997 to 2011 have been retrieved from the Italian National Network of Durum Wheat in 10 experimental sites across Italy: data related to yield, number of grain, weight of grain and date of heading were collected in all the sites for 4 among the most common cultivars of durum wheat cultivated in Italy (cv. Creso, Iride, Simeto and Duilio). The experimental sites are managed by different institutes

following a common protocol that defines the experimental scheme and the main surveys to perform, in order to guarantee homogeneity of data.

Results and Discussion

Preliminary results highlight the advanced date of heading of the 3 recent cultivars Iride, Duilio and Simeto compared to Creso (by about 8-10 days) and, at the same time, higher yields: respectively 5.5, 5.3 and 5.3 t ha⁻¹ compared to 4.7 t ha⁻¹. This is due to longer grain filling period which characterises the new cultivars (Arduini et al., 2006).

Despite a quite large variation among years, the number of grain is specific for each cultivar (i.e. low for Simeto, high for Iride) but there is always high correlation to yield ($0.83 < r^2 < 0.76$). The number of grain and yield are negatively affected in all cultivars by hot days during the grain determination phase. However more recent cultivars show lower coefficient of variability among years, thus, suggesting higher yield stability and lower stress sensitivity. This is particularly evident in southern Italy where crops are frequently exposed to unfavourable conditions. However, durum wheat shows in some years negative anomalies without the concurrence of hot days during grain determination, most probably due to water stress. A crop model (Wofost) will be run in all sites under analysis to help in disentangling the high temperature and water stresses occurred during crop growth and/or reproductive phase.

Although this dataset collected by the National Network on durum wheat was not intentionally build to calibrate crop model, it represents a great opportunity to support the crop modeling linkage to genetics, as it is the largest dataset available related to yield and yield-component for the most common cultivars of durum wheat cultivated in Italy.

Conclusions

Recent cultivars of durum wheat show higher yield in all sites across Italy and less coefficient of variation particularly in the south of Italy. Hot days during the grain determination negatively affected number of grain and yield in all cultivars. Large dataset of cultivars changes under field conditions are fundamental to improve and support crop modeling linkage to genetics.

Acknowledgements

Authors gratefully acknowledge the participants to the National Network of Durum Wheat, financed by the Ministry of Agricultural, Food and Forestry Policies, to collect data related to different cultivars of durum wheat in Italy.

References

- Arduini, I., A. Masoni, L. Ercoli, M. Mariotti, (2006). *European Journal of Agronomy* 25: 309–318.
- Eyshi Rezaei, E., H. Webber, T. Gaiser et al., (2015). *European Journal of Agronomy*, 64: 98–113.
- Fontana, G., A. Toreti, A. Ceglar, G. De Sanctis, (2015). *Natural Hazards Earth System Science*, 15: 1631–1637.
- Porter, J.R. and M. Gawith, (1999). *European Journal of Agronomy*, 10: 23–36.
- Siebert, S., F. Ewert, E. Eyshi Rezaei et al., (2014). *Environmental Research Letters*, 9:044012 (8pp).

Modeling climate change impacts on grapevine phenology in Portugal: a statistical approach

*J. A. Santos*¹ – *H. Fraga*¹ – *J. Moutinho-Pereira*¹ – *C. Carlos*² – *J. Silvestre*³ – *J. Eiras-Dias*³ – *T. Mota*⁴ – *A. C. Malheiro*¹

¹ Centre for the Research and Technology of Agro-Environmental and Biological Sciences, Universidade de Trás-os-Montes e Alto Douro, 5000-801 Vila Real, Portugal, e-mail: jsantos@utad.pt

² Associação para o Desenvolvimento da Viticultura Duriense, Quinta da Santa Maria, 5050-106 Godim, Portugal

³ Instituto Nacional de Investigação Agrária e Veterinária, I.P., Quinta da Almoinha, 2565-191 Dois Portos, Portugal

⁴ Comissão de Viticultura da Região dos Vinhos Verdes, Estação Vitivinícola Amândio Galhano, Paçô, 4970-249 Arcos de Valdevez, Portugal

Introduction

Statistical phenological models are strategic tools for the planning of winemaking activities and for assessing the impacts of climate change (Jones et al., 2005; Moriondo and Bindi, 2007). Regarding the Portuguese grapevine varieties, no previous research was focused on the impacts of climate change on phenology. Hence, this issue is critical for the selection of the most suitable varieties under future climatic conditions (Tomasi et al., 2011; Webb et al., 2011). In the current study, statistical models are developed to capture the phenological variability of some of the main varieties grown in Portugal. Additionally, the models are applied to different climate change scenarios, in order to examine the future impacts on grapevine phenology.

Materials and Methods

The phenological time series of Budburst (BUD), Flowering (FLO) and Veraison (VER) for Fernão-Pires (white) and Castelão (red) varieties were selected for model calibration and validation. Monthly average minimum (Tmin), maximum (Tmax) and mean (Tmean) temperatures were selected as potential regressors by a stepwise procedure. A leave-one-out validation scheme was also applied. The final regression models are based on the following predictors: Tmin in January-February-March for BUD, Tmax in March-April for FLO, and Tmin, Tmax and Tmean in March-July for VER.

Results and Discussion

Developed models showed a high skill after cross-validation (cv), representing 63-69% of total variance for BUD, 79% for FLO and 77-88% for VER (Table 1). Model errors were in most cases <5 days, outperforming classic growing degree-day models, including models based on optimized temperature thresholds for each variety. Applied to the future scenarios RCP4.5/8.5, projections indicate earlier phenophase onsets and shorter interphases for all varieties (Fig. 1).

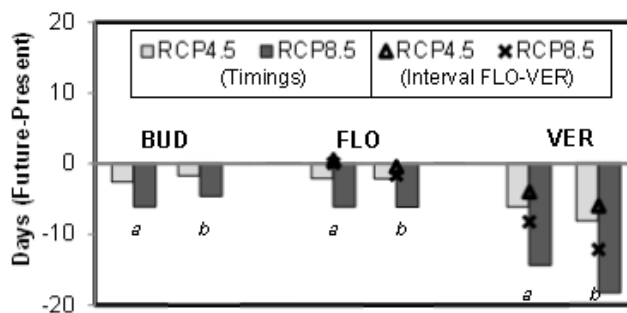

Figure 1. Differences (Future - Present: 2040–2070 minus 1990–2011) in the number of days required to reach budburst (BUD), flowering (FLO) and veraison (VER) for a) Fernão-Pires and b) Castelão

Table 1. Regression models for each phenophase of Fernão-Pires and Castelão. Skill parameters for all models are shown: R_{cv}^2 and RMSE

	Budburst		Flowering		Veraison	
	Fernão-Pires	Castelão	Fernão-Pires	Castelão	Fernão-Pires	Castelão
R_{cv}^2	0.63	0.69	0.79	0.79	0.77	0.88
RMSE	4.48	4.63	3.85	3.90	5.00	2.89

Conclusions

The current study highlights the future changes in phenological timings for the Portuguese grapevine varieties. These changes may bring significant challenges to the Portuguese winemaking sector, stressing the need for suitable adaptation/mitigation strategies, to ensure its future sustainability.

Acknowledgements

This study was supported by national funds by FCT - Portuguese Foundation for Science and Technology, under the project UID/AGR/04033/2013. This work was also supported by the project "ModelVitiDouro" - PA 53774", funded by the Agricultural and Rural Development Fund (EAFRD) and the Portuguese Government by Measure 4.1 - Cooperation for Innovation PRODER program - Rural Development Programme.

References

- Jones, G.V., White, M.A., Cooper, O.R. and Storchmann, K. (2005). Climate Change and Global Wine Quality. *Clim Change*, 73(3): 319-343.
- Moriondo, M. and Bindi, M. (2007). Impact of climate change on the phenology of typical mediterranean crops. *Italian Journal of Agrometeorology*, 3: 5-12.
- Tomasi, D., Jones, G.V., Giust, M., Lovat, L. and Gaiotti, F. (2011). Grapevine Phenology and Climate Change: Relationships and Trends in the Veneto Region of Italy for 1964-2009. *Am J Enol Vitic*, 62(3): 329-339.
- Webb, L.B., Whetton, P.H. and Barlow, E.W.R. (2011). Observed trends in winegrape maturity in Australia. *Global Change Biol.*, 17(8): 2707-2719.

"Simulation Modelling in Botanical Epidemiology and Crop Loss Analysis": An online course in The Plant Health Instructor, the APSnet Education Center

*S. Savary*¹ – *K. Bowen*² – *K. L. Stevenson*³ – *L. Willocquet*⁴

¹ UMR AGIR, INRA, Castanet Tolosan-Toulouse, France

² Department of Entomology and Plant Pathology, College of Agriculture, Auburn Univ., AL, USA

³ Department of Plant Pathology, College of Agric & Environm Sci, Univ. Georgia, GA, USA

⁴ UMR AGIR, INRA, Castanet Tolosan-Toulouse, France ; laetitia.willocquet@toulouse.inra.fr

Introduction

Simulation models are powerful tools to synthesize and integrate quantitative information in the biological sciences. They also can be good educational tools, providing intuitive, hands-on access to analysing plant-pathogen (pest) systems. Simulation modelling is derived from the concepts of systems analysis, making use of numerical integration, and has been used for decades in various fields of ecological and agricultural sciences. The approach allows identifying key processes that govern a dynamic system (e.g., the dynamics of an epidemic), and exploring “futures” through scenario analyses.

An online course was developed to highlight, illustrate, and implement the linkages between simulation models, experiments, and data (Savary and Willocquet, 2014; Savary et al., 2014). The course focuses on a mechanistic simulation approach, which is visual and involves as little calculus as possible in order to bridge the gap between 'observers' and 'modellers'.

Materials and Methods

The course first introduces basic concepts and simple examples of systems analysis and simulation modelling. It then focuses on plant disease epidemics and crop yield losses. Simulation models are provided to explore model structures, their behaviour, and the effect of key parameters (at the sub-process level) on system (process level) dynamics. The course includes 10 chapters:

1. Simulation Models: Why? Who? When?
2. Systems, Models, and Simulation
3. Preliminary Examples of Simulation Models
4. A Preliminary Epidemiological Example
5. An Epidemiological Model Including Crop Growth and Senescence
6. Modelling the Effects of Host Plant Resistance on Plant Disease Epidemics
7. Crop Growth Modelling - Introducing GENECROP as a Framework
8. Modelling Yield Losses Due to Pests - The GENEPEST Structure
9. The RICEPEST and WHEATPEST Models
10. Meaning, Use, and Limits of Simulation Models

Each chapter is illustrated by tables and figures, includes examples of simulation models, and can be downloaded freely from the APS website. The models can be run using STELLA, a user-friendly software program for simulation modelling.

Results and Discussion

The course materials allow understanding processes involved in plant disease epidemics and the physiological effects of injuries caused by pests (pathogens, insects, weeds) on crop growth and yield. The different chapters describe step-by-step how these processes can be embedded into simulation models. The example models allow one to explore the behaviour of the modelled system through visualization of simulated outputs according to selected input parameters or drivers.

Figure 1 illustrates the case of yield loss modelling, where leaf area index (LAI) and wheat head dry biomass are simulated in 4 cases: a crop with no disease, a crop injured by leaf rust (LR), a crop injured by Septoria tritici blotch (STB), and a crop injured by both diseases. Note that in this case, the injuries (diseases) are dynamic inputs to the agrophysiological model, and are entered as model drivers, in the same way as are daily weather variables.

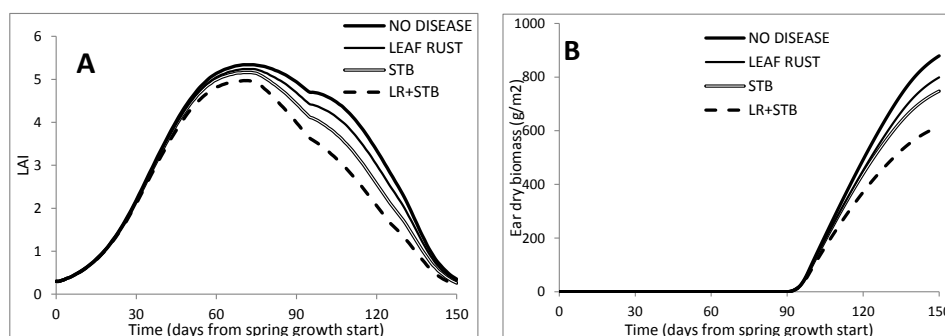

Figure 1. Example of simulated leaf area index (LAI) and head dry biomass of a wheat crop with no injury, injured by leaf rust (LR), Septoria tritici blotch (STB) and both LR and STB. Maximum LR and STB severity is 10% and 20%, respectively.

Conclusions

The teaching materials of this module provide an introduction to basic concepts and tools for modelling in the plant health sciences. They have been used in several international workshops and can also be used in classes.

References

- Savary S. and Willocquet L. (2014). Simulation Modeling in Botanical Epidemiology and Crop Loss analysis. APSnet Education Center. The Plant Health Instructor. DOI: 10.1094/PHI-A-2014-0314-01.
- Savary S., Bowen K., Stevenson K.L., Willocquet L. (2014). An online course "Simulation Modeling in Botanical Epidemiology and Crop Loss Analysis" in The Plant Health Instructor on the APSnet Education Center. APS Annual Meeting, Minneapolis, 9-13 August 2014. *Phytopathology* 104(Suppl. 3):S3.104.

Understanding the effect of extreme heat on crop yields

B. Schauberger^{1*} – *K. Frieler*¹ *et al.*,

¹ Climate Impacts and Vulnerabilities, Potsdam Institute for Climate Impacts Research, Telegrafenberg A56, D-14473 Potsdam; *Corresponding author: schauber@pik-potsdam.de

Introduction

Temperatures above a certain threshold are particularly harmful for crop yields, raising concerns of decreasing agricultural production under increasing global warming. Global Gridded Crop Models (GGCMs) are our primary tools to project crop yield responses at a global scale by providing an implementation of our current understanding of the underlying physiological processes. Therefore we use an ensemble of eight GGCMs to assess maize and soybean yield performance under extreme heat in the contiguous US. Historic (1980-2010) simulations are compared to observed yield responses and the effects of heat stress dissected. Additionally we study the interactive effects of CO₂ fertilization, irrigation and extreme heat at the end of the century under strong global warming (RCP8.5).

Materials and Methods

We use AgMERRA climate data at 0.5° resolution, simulated yields from eight crop models from the GGCM initiative in AgMIP and historical yield data from the USDA database from 1980 to 2010 (only predominantly rainfed counties according to MIRCA2000). Future simulations were produced with climate data from the HadGEM2 model under RCP8.5 and SSP2 from 2071 to 2099. The regression model relates yield to temperature exposure times (adopted from (Schlenker and Roberts, 2009)); all data are pooled to increase the frequency of extreme events in the total data set.

Results and Discussion

Most of the models reproduce the drop in observed US county yields at temperatures above 30°C for maize and soybean under rain-fed conditions (Figure 1 left panel; only maize is shown here, but all results are similar for soybeans). The rainfed model ensemble closely follows the shape for the observed yields. These thresholds correspond well with experimentally deduced values (e.g. Luo, 2011; Rötter and Van de Geijn, 1999). When simulating full irrigation the yield depression at high temperatures disappears, indicating a prominent role of water stress at elevated temperatures (rather than direct physiological damages). The hypothesis of a twofold water stress (increased transpiration from higher atmospheric demand, and lower supply due to increased soil evaporation) has been stated earlier (Lobell et al., 2013) and is confirmed by our model ensemble.

These results are robust under different simulation setups (data not shown). Future yield simulations (Figure 1, right panel) clearly show that irrigation increases yields more than the fertilization from higher levels of CO₂, by mitigating the water-deficit

caused by extreme heat episodes. High temperatures are likely to prevail more frequently at the end of the century, as the temperature histograms in the bottom part suggest. Differences between model and observed yield responses are used to derive model improvement suggestions.

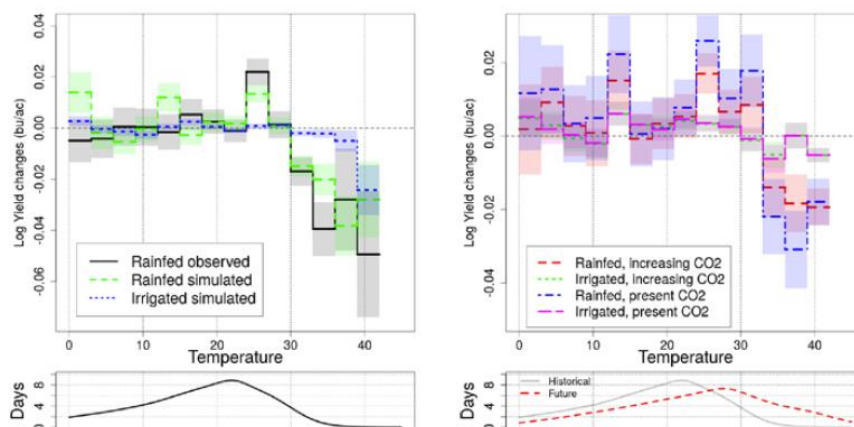

Figure 1. Left panel: Response of historic observed rainfed (black solid line) and simulated ensemble rainfed (dashed) or irrigated (dotted lines) US maize yields to temperature exposure. Right panel: Simulated ensemble US maize from 2071 to 2099 under different CO₂ and irrigation combinations. Bottom parts of each panel show the temperature distribution over the growing season. Shaded areas are 95%-confidence intervals. Note the different scales for past and future. The curves for soybeans look similar.

Conclusions

GGCMs are capable of reproducing observed detrimental effects of heat stress on crop yields. The nature of the heat stress is identified to actually cause water stress, evidenced by the strong amelioration of yield depression with irrigation. Yield responses to combinations of heat stress and different [CO₂] depends on whether they are irrigated (no detectable fertilization effect and yield drop disappears) or rainfed (heat stress effects only slightly reduced by increasing [CO₂]).

Acknowledgements

BS acknowledges support from the German National Academic Foundation. The work was supported within the framework of the Leibniz Competition (SAW-2013-PIK-5), from EU FP7 project HELIX (grant no. FP7-603864-2), and by the German Federal Ministry of Education and Research (BMBF, grant no. 01LS1201A1).

References

- Schlenker, W., and M. J. Roberts (2009). PNAS 106 (37):15594-15598.
- Lobell, D. B., G. Hammer, G. McLean et al., (2013). Nature Climate Change 3 (5):497-501
- Luo, Q. (2011). Climatic Change 109 (3-4):583-598.
- Rötter, R. P. and S. Van de Geijn (1999). Climatic Change 43:651-681

Modelling of the tree yield in an alley cropping system

D.-M. Seserman¹ – A. Quinkenstein² – D. Freese²

¹ Chair of Soil Protection and Recultivation, Faculty of Environmental Sciences and Process Engineering, Brandenburg University of Technology Cottbus–Senftenberg, Address: Konrad-Wachsmann-Allee 6, D-03046 Cottbus, Germany, E-mail: seserman@b-tu.de

² Chair of Soil Protection and Recultivation, Faculty of Environmental Sciences and Process Engineering, Brandenburg University of Technology Cottbus–Senftenberg

Introduction

Alley cropping for the production of woody biomass is a land use system in which hedgerows of fast growing trees are established as parallel strips on conventionally managed agricultural fields. This design allows for the simultaneous production of food/feed and biomass, while developing economically and ecologically beneficial interactions, such as wind protection (Grünwald et al., 2007; Quinkenstein et al., 2009). The aim of the study presented here was to determine the suitability of the Yield-SAFE model, a process oriented model for predicting the production in agroforestry systems (Keesman et al., 2011), to model the annual yields of poplar (*Populus maximowiczii* A. Henry x *Populus nigra* L., cv. Max) and black locust (*Robinia pseudoacacia* L.) over a time period of four and five years, respectively, taking into consideration the water constraints (Mantovani et al., 2014). Measured field data has been used for the model calculations.

Materials and Methods

The tree biomass was estimated between 2011 and 2014 for poplar and between 2010 and 2014 for black locust using values of shoot basal diameters measured every year, in winter, and a simple allometric relation of the form $M=aD^b$, with a and b allometric coefficients determined by empirical data, and with M as the total aboveground tree dry biomass for a specific basal diameter, D (Böhm et al., 2011). The allometric relation was developed with tree weights and shoot basal diameters derived from destructive sampling of selected trees in February 2015. Model parameters characterizing soil conditions, management practices and weather data over the specified time period were taken from own measurements and scientific literature (Keesman et al., 2011). Once calibrated, the model output was predicted by using the internal fitting procedure of the Yield-SAFE model and was validated with the derived biomass estimations.

Results and Discussion

The results show a substantial difference between the growth performance of both tree species with lower growth increments for black locust and higher growth increments for poplar during the later years. Over the simulation period the modelled tree biomass of poplar and black locust corresponded well with the measured values

(Fig. 1). However, the accuracy of the model output was lower for the initial and higher for the later years. The reason for this might be the fitting procedure, which focuses on a correct fit only for the last year. Regarding the deviations between the modelled yield and the estimated one, it was noticed that at the end of the investigation period the deviation for poplar was of -0.43 % after four years and the deviation for black locust was of -1.93 % after five years, meaning that the model made very small overestimations of tree yield. Finally, the Yield-SAFE model was able to offer realistic predictions of tree growth over time.

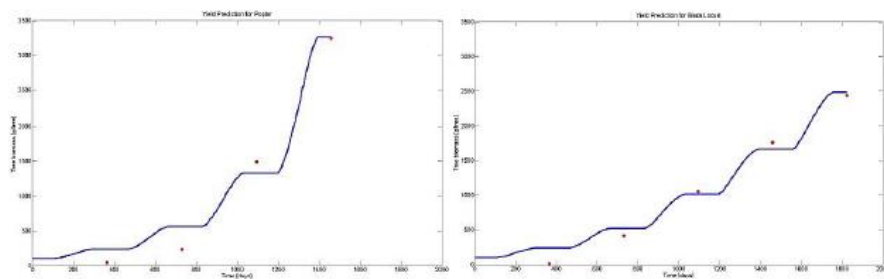

Figure 1. The modelled yield (line), adjusted with estimated yields (points) for poplar (left) and black locust (right) over a time period of four and five years, respectively

Conclusions

Within the presented study the suitability of the Yield-SAFE model to predict the above ground woody biomass of fast growing trees was assessed. Plausible in results, the model was able to predict the tree biomass of poplar and black locust at the end of the simulation period with satisfying accuracy. Nevertheless, future work should include an improvement of the fitting procedure, in order to make the model output more reliable over the early growth years. Also, the obtained results for trees will be completed by crop yield modelling aiming on the interaction in alley cropping systems.

References

- Böhm, C., A. Quinkenstein and D. Freese (2011). Yield prediction of young black locust (*Robinia pseudoacacia* L.) plantations for woody biomass production using allometric relations. *Annals of Forest Research*, 54 (2): 215–227.
- Grünewald, H., B.H.V. Brandt, B. Schneider et al., (2007). Agroforestry systems for the production of woody biomass for energy transformation purposes. *Ecological Engineering*, 29: 319–328.
- Keesman, K.J., A. Graves, W. van der Werf et al., (2011). A system identification approach for developing and parameterising an agroforestry system model under constrained availability of data. *Environmental Modelling & Software*, 26: 1540–1553.
- Quinkenstein, A., J. Wöllecke, C. Böhm et al., (2009). Ecological benefits of the alley cropping agroforestry system in sensitive regions of Europe. *Environmental Science & Policy*, 12: 1112–1121.
- Mantovani, D., M. Veste and D. Freese (2014). Black locust (*Robinia pseudoacacia* L.) ecophysiological and morphological adaptations to drought and their consequence on biomass production and water-use efficiency. *New Zealand Journal of Forestry Science*, 44 (29): 1–11.

Sensitivity of winter oilseed rape production in Denmark towards climate change using regression techniques

*B. Sharif*¹ – *D. Makowski*² – *F. Plauborg*¹ – *J. E. Olesen*¹

¹ Department of Agroecology, Aarhus University, Blichers Allé 20, Tjele, Denmark, behzad.sharif@agro.au.dk

² Institut National de Recherche Agronomique, Thiverval-Grignon, France

Introduction

Winter oilseed rape (*Brassica napus L.*) is widely cultivated in Denmark. Therefore, it is important to investigate the effect of climate change on its production. There have been several studies on effects of different factors on winter oilseed rape production (Diepenbrock, 2000; Rathke et al., 2006). Regression models are one way of deriving such relation between climate and crop yield, but in most studies only one regression technique for coarse temporal resolutions are applied due to technical issues such as collinearity between input variables (e.g. Lobell and Burke, 2010). In this study, an ensemble of regression techniques was used for different model equations and temporal resolutions to test the sensitivity of winter oilseed rape yield to change in climate variables.

Materials and Methods

A dataset of 689 experiments of winter oilseed rape variety trials with common management practices from 1992 to 2013 throughout Denmark was collected from Danish Agricultural Advisory Service. Final yield was considered as the response variable. Climate variables (temperature, precipitation and radiation), sowing date, previous crop and soil type were considered as input variables. Both monthly and fortnightly resolutions for averaging climate data were used. Yield was assumed to be related to the input variables as follows:

$$Yield_j = b_0 + b_1 \times YEAR_j + \sum_{i=1}^n b_{2i} \times TEMP_{ij} + \sum_{i=1}^n b_{3i} \times RAD_{ij} + \sum_{i=1}^n b_{4i} \times PREC_{ij} + \sum_{i=1}^n b_{5i} \times TEMP_{ij}^2 + \sum_{i=1}^n b_{6i} \times RAD_{ij}^2 + \sum_{i=1}^n b_{7i} \times PREC_{ij}^2 + b_8 \times SOIL_j + b_9 \times Pre_{CROP_j} + b_{10} \times Sowing_{DOY_j} + b_{11} \times Sowing_{DOY_j}^2 + \varepsilon_j$$

Where *TEMP*, *PREC* and *RAD* denote temperature, precipitation and radiation, respectively. *i* is the time period of the growing season and *j* stands for each site. *Soil*, *Pre_{CROP}* and *Sowing_{DOY}* denote soil type (sandy/clayey), previous crop (cereals/grass/pea/bare soil) and sowing day of year, respectively. b_0, b_1, \dots, b_{11} are the coefficients to be estimated by regression techniques and ε is the residual error.

Apart from the above-mentioned “Quadratic” equation with both linear and quadratic terms, two other alternative formulas were also considered. For “Linear” equation, only linear terms were considered. An “Intermediate” equation was also used, where among climatic variables, only temperature (linear term) and precipitation (both linear and quadratic terms) were included in the model. The growing period is assumed to begin at first of August and lasts for one year.

Seven regression techniques including Ordinary Least Squares (OLS), stepwise, Principle Components Regression (PCR), Partial Least Squares Regression (PLSR), Ridge regression, Lasso and Elastic Nets were applied over three types of equations and two temporal resolutions as stated above. The estimated coefficients were used to test the sensitivity of models to temperature increase.

Results

Figure 1 shows the sensitivity of the developed models to +1°C increase in temperature over the whole growing season. Although almost all models show a positive response with regard to winter oilseed rape production, the amount of predicted yield change highly depends on the regression technique, temporal resolution and model equation. Therefore, it is recommended that an ensemble of regression techniques should be applied when dealing with several input variables.

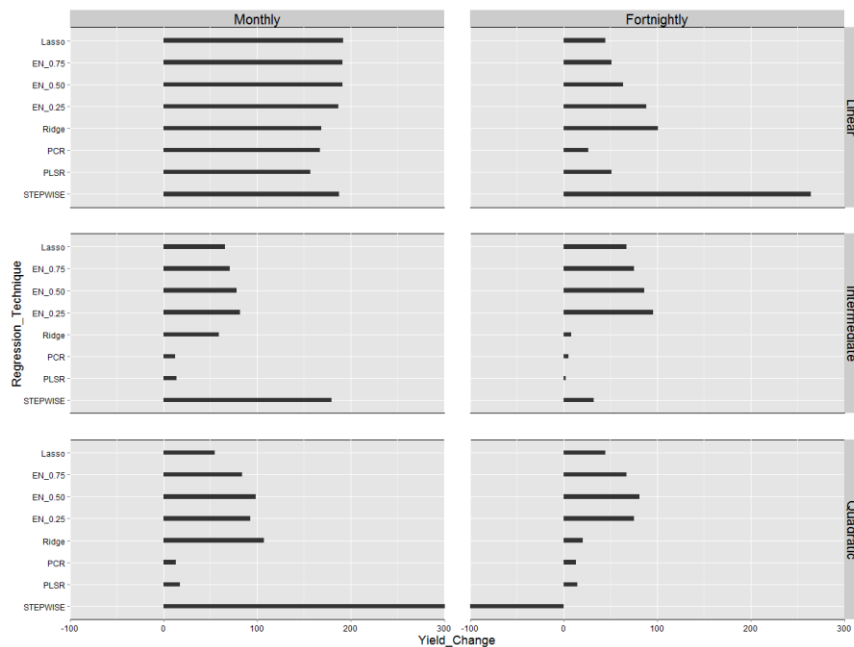

Figure 1. Sensitivity of yield change (kg/ha) towards temperature increase of +1°C for different regression techniques, model equations and temporal resolution. OLS found to be significantly worse than all other models, hence was removed from this comparison. For Elastic Nets, 3 values for alpha was used.

References

- Diepenbrock, W. (2000). *Field Crop Res* 67: 35-49.
 Rathke, G.W., T. Behrens, W. Diepenbrock (2006). *Agr Ecosyst Environ* 117: 80-108.
 Lobell, D.B., M.B. Burke (2010). *Agr Forest Meteorol* 150: 1443-1452.

Application of a systems model to spatially complex irrigated agricultural systems

J. Sharp – H. Brown

Systems Modelling, Sustainable Production, The New Zealand Institute for Plant and Food Research Limited, Private Bag 4704, Christchurch 8140, New Zealand. e-mail: joanna.sharp@plantandfood.co.nz

Introduction

Although New Zealand (NZ) is water-rich, many of the intensively farmed lowland areas suffer frequent summer droughts. Irrigation schemes have been developed to move water from rivers and aquifers to support agricultural production. This has seen a 70% increase, to 750,000 ha, in irrigated land over the last 8 years (Statistics NZ, 2010). The production and economic benefits are substantial, and in the summer of 2011/12 irrigation contributed \$NZD 2.17 billion to GDP (NZIER, 2014). The NZ government is also investing a further \$NZD 435 million to encourage development of additional infrastructure and this is expected irrigate a further 350,000 ha by 2035 (NZIER 2014). To improve returns on this investment and meet freshwater protection targets, tools and recommendations to enable irrigation practices that improve water use efficiency (WUE), reduce run-off, drainage, and subsequent nutrient losses, are seen as an essential component of achieving fresh water policy goals (MFE 2013).

Lateral or centre pivot sprinklers make up 74% of irrigation systems, with many adapted for variable rate irrigation (VRI), and these consequently provide greater sophisticated control of water application. To develop tools and recommendations that consider both water dynamics and profitability of these irrigated cropping systems, a framework for an existing systems model was constructed that could capture the variability in soil, cropping systems, and irrigation application observed under a single irrigator with constrained water and infrastructure availability.

Materials and Methods

The systems model used in this study was APSIM next generation (APSIM Initiative, 2015), a current prototype of an updated version of the Agricultural Production Systems sIMulator (APSIM) (Holzworth et al., 2014). The model chosen is able to simulate systems that cover a range of plant, soil, climate and management interactions, while the software architecture in the updated application allowed faster run times for complex simulation setups, more robust software architecture, clearer and consistent code language, and multiple simulations running concurrently.

An advanced irrigation module was built to translate irrigator specifications into spatial and temporal application events, and a module for calculating gross margins for irrigated systems was created. To consider the multiple layers of variability in soil, crop, landscape position and infrastructure present under a single irrigator, a multiple patch approach was required. A set of methods to create multiple patch simulations in APSIM, with many patches that were spatially aware, interconnected and could run

concurrently was developed. These patches, with identifying tags, may have differing soil characteristics, crop management, slope and position in the landscape but were controlled by overarching management routines. These routines linked into each patch and determined application depth and timing of irrigation, as well as surface run-on/off, based on irrigator specifications, soil water, infiltration capacity, and irrigation application rate. The system developed also allowed limitations to be placed on fixed resources, such as water and infrastructure, to enable scenario analysis to be undertaken in a constrained system. Outputs from the simulations, such as water application, yield, drainage, profitability and WUE, can then be mapped spatially.

Results and Discussion

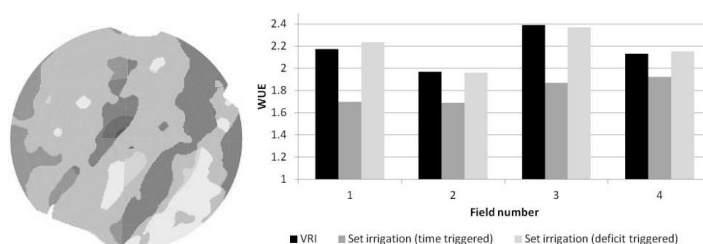

Figure 1. Example outputs of WUE in wheat under a centre pivot irrigator with multiple irrigation strategies, considering spatial variability in soil properties and cropping management

While at the early application stage, the advanced irrigation module and multi-patch framework can model the water uses and profitability of different irrigation options. Figure 1 shows an example of these outputs. It will then be used to conduct scenario analyses to determine guidelines for irrigation requirements on landscapes with differing extents of variability in soil, crop and irrigation infrastructure. This model will also be used to run case studies to demonstrate the financial and environmental benefits in adopting water efficient management and irrigation techniques.

Conclusions

This work provides a useful tool to extend the application of an existing systems model to spatially complex irrigated systems.

Acknowledgements

Funding received from the MBIE Maximizing the Value of Irrigation program.

References

- APSIM Initiative (2015) APSIM (next generation). [https://www.apsim.info/Documentation/APSIM\(nextgeneration\).aspx](https://www.apsim.info/Documentation/APSIM(nextgeneration).aspx)
- Holzworth, D., Huth, N. et al., (2014) APSIM – Evolution towards a new generation of agricultural systems simulation. *Environmental Modeling & Software*. 62:327-350.
- MFE (2013) National Policy Statement for Freshwater Management 2011 <http://www.mfe.govt.nz/rma/central/nps/freshwater-management.html>
- NZIER (2014) Value of irrigation in New Zealand. NZIER report, Wellington.

CRAFT: A multi-scale and multi-model gridded framework for running crop simulation models

*V. Shelia*¹ – *J. Hansen*² – *V. Sharda*¹ – *C. Porter*³ – *M. Zhang*³ – *P. Aggarwal*⁴ –
*G. Hoogenboom*¹

¹ AgWeatherNet, Washington State University, Prosser, WA, USA, e-mail: vakhtang.shelia@wsu.edu

² CGIAR Research Program on Climate Change, Agriculture and Food Security (CCAFS), International Research Institute for Climate and Society (IRI), Columbia University, NY, USA

³ Department of Agricultural and Biological Engineering, University of Florida, Gainesville, FL, USA

⁴ The South Asia Regional Program for CCAFS, International Water Management Institute, New Delhi, India

Introduction

In the light of the changing climatic conditions and increasing food demand in the world, improved climate risk management and agricultural decision support systems are needed to aid with appropriate selection of practices and strategies. CCAFS has initiated the development of a new framework for a spatial decision support system for short and long-term yield forecasting and agricultural risk analysis associated with the increasing climate variability and extreme events, as well as climate change.

Materials and Methods

The CCAFS Regional Agricultural Forecasting Toolbox (CRAFT) is a framework for running different preinstalled crop models under a unified user interface and to spatially aggregate the results into interactive thematic maps. It includes the following main components: a) a user-friendly client application - C# program which provides the interface to the crop models and database, b) a MySQL database implementation that contains all input and output data of the models, including crop management, soil, weather, and climate data and c) an integrated GIS object, which is used for the visualization of gridded results using thematic maps. The main window of the user interface displays the primary tasks including: data import/export, crop management inputs, project definitions and modification, crop simulations, analysis of results, and system configuration. CRAFT is designed to use spatial data schemes through the use of 5 arc minute and 30 arc minute resolution grids. Schematization at three different spatial scales, including the country, state/province and district levels, are considered using three different levels of GIS shape files. The gridded input data required for the crop models include weather and soil conditions, cultivar and other management levels that must be prepared using ArcGIS or provided templates and then imported into the CRAFT database. CRAFT is integrated with external engines; one for crop modeling for spatial crop simulations and one for seasonal climate forecasts using the Climate Predictability Tool (CPT) developed by the International Research Institute for Climate and Society (IRI). The crop modeling engine, which is the top level class, provides the interface for the support of multi crop model capabilities using the harmonized data format (ACE) and crop model data translation tools that have been developed by the Agricultural Model Intercomparison and Improvement Project

(AgMIP), or extend it explicitly for a specific crop model. In the current version the Cropping System Model (CSM) of DSSAT (Hoogenboom et al., 2015; Jones et al., 2003) and APSIM (Keating et al., 2003) have been implemented. CRAFT as a framework for an ensemble of crop models simulates yield for each individual grid cell based on the predefined inputs and using statistical forecasting based on the seasonal predictors yields are adjusted. Through spatial aggregation and probabilistic analysis of the forecast uncertainty for both short- and long-term periods, predicted yield can be determined for a region at different spatial resolutions. CRAFT includes options for hind-cast analysis, de-trending, and post-simulation calibration of model predictions from historical agricultural statistics.

Results and Discussion

Several case studies that have been conducted by CCAFS stakeholders using CRAFT for six Asian countries are promising. Future work will concentrate on the implementation of the InfoCrop and SARA-H crop simulation models and to add additional crops, such as peanut, sorghum, and millet to the CRAFT framework.

Conclusions

CRAFT can support the efforts of governments, policy makers, and scientists to better prepare for the potential impact of climate variability on crop and rangeland production over a region based on the simulation results of different crop models.

Acknowledgements

CRAFT was developed by an initiative of the CGIAR Research Program on Climate Change, Agriculture and Food Security (CCAFS) in collaboration with IRI, Asia Risk Center, University of Florida and Washington State University.

References

- Hoogenboom, G., J.W. Jones, P.W. Wilkens, C.H. Porter, K.J. Boote, L.A. Hunt, U. Singh, J.I. Lizaso, J.W. White, O. Uryasev, R. Ogoshi, J. Koo, V. Shelia, and G.Y. Tsuji (2015). Decision Support System for Agrotechnology Transfer (DSSAT) Version 4.6 (www.DSSAT.net). DSSAT Foundation, Prosser, Washington.
- Jones, J.W., G. Hoogenboom, C.H. Porter, K.J. Boote, W.D. Batchelor, L.A. Hunt, P.W. Wilkens, U. Singh, A.J. Gijsman, and J.T. Ritchie (2003). DSSAT Cropping System Model. *European Journal of Agronomy* 18:235-265.
- Keating, B.A., Carberry, P.S., Hammer, G.L., Probert, M.E., Robertson, M.J., Holzworth, D., Huth, N.I., Hargreaves, J.N.G., Meinke, H., Hochman, Z., McLean, G., Verburg, K., Snow, V., Dimes, J.P., Silburn, M., Wang, E., Brown, S., Bristow, K.L., Asseng, S., Chapman, S., McCown, R.L., Freebairn, D.M., Smith, C.J. (2003). An overview of APSIM, a model designed for farming systems simulation. *European Journal of Agronomy* 18, 267-288.

Yield potentials and yield gaps of soybeans in Austria – a biophysical and economic assessment

*F. Sinabell*¹ – *K. Mechtler*² – *H. Mitter*³ – *E. Schmid*³ – *A. Zimmermann*⁴

¹ Austrian Institute of Economic Research, Vienna, Austria, franz.sinabell@wifo.ac.at

² Austrian Agency for Health and Food Safety, Vienna, Austria

³ Institute for Sustainable Economic Development, University of Natural Resources and Life Sciences, Vienna, Austria

⁴ Institute for Food and Resource Economics, University of Bonn, Germany

Introduction

The deviation of observed crop yields on farms from those in field trials has been an important research topic. Bringing farm yields closer to potential yields is seen as a prerequisite to increase profitability in agriculture. At the aggregate level, crop yield gaps are considered to have widespread effects for global and regional food availability. Yield gaps are usually driven by heterogenous biophysical conditions including climate, soil and topography as well as by managerial (e.g. use of fertilizers and pesticides, tillage, cultivars) and socioeconomic conditions such as legal regulations, commodity prices and agricultural policy premiums. Most studies focused either on the biophysical drivers of crop yield gaps or on economic assessments. Our research adds to the scientific literature by integrating biophysical and socioeconomic aspects of one specific crop in a data rich country in a coherent study. Yield potentials are defined in biophysical and economic terms to allow for a bioeconomic assessment. The case study is on soybeans in Austria.

Materials and Methods

As suggested in the literature (van Ittersum et al., 2013), it is "essential that yield gap studies provide clarity regarding their underpinning assumptions, models and parameters and include verification with measured data". We follow this claim by exploring soybean yield potentials from various angles: We compare (i) observed crop yields provided by the official agricultural statistics, (ii) observed crop yields from sample farms (the Farm Accountancy Data Network FADN), (iii) results from spatially and temporally specific simulations of the biophysical process model EPIC (Environmental Policy Integrated Climate; Williams, 1995; Mitter et al., 2015) (iv) and records from field trials on research stations operated by the Austrian Agency for Health and Food Safety. The biophysical data are complemented by observations on socioeconomic factors like farm characteristics and economic and management variables (e.g. input and output prices and agricultural policy premiums) from the sample farms. Statistical analyses are applied to explain deviations of soybean yield potentials and actually realized yields. Biophysical factors are derived using multiple regression statistics. The economic assessment is conducted by a stochastic frontier analysis. This method (see e.g. Neumann et al., 2010) is applied to quantify the impact

of biophysical, management and socioeconomic factors on soybean yields and facilitates the explanation of observed deviations from technically efficient production.

Expected results and discussion

Figure 1 provides an illustrative example for the development of soybean yields in Austria. Whereas upper confidence intervals show observed yields up to 4.5 t/ha, average realized yields range between 2 and 2.5 t/ha with a slightly positive trend. The example is based on 103 FADN farms on average from 1995 to 2011. Final results of the study will be available in early 2016.

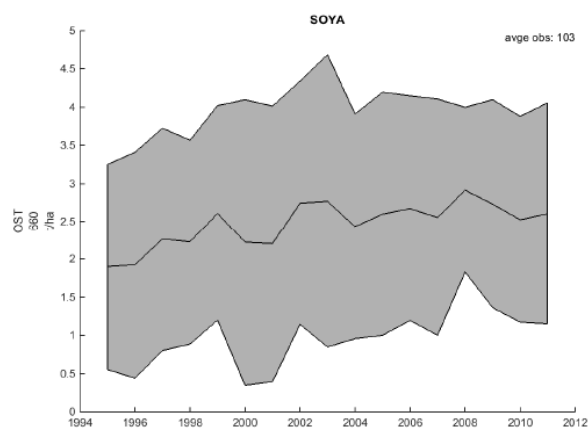

Figure 1. Mean soybean yields and upper and lower confidence intervals in Austria 1995-2011, data: FADN.

The results will allow us to compare yields of average farms and of farms close to the efficiency frontier, yields of a crop model and of field trials before and after controlling for biophysical factors. The benefits of including socioeconomic variables, management variants and yields of technically efficient farms will be discussed and conclusions for further studies on yield gaps will be drawn.

References

- Mitter, H., E. Schmid, F. Sinabell (2015). Integrated modeling of protein crop production responses to climate change and agricultural policy scenarios in Austria. *Climate Research*, Vol. 65: 205–220, 2015, doi: 10.3354/cr01335
- Neumann, K., Verburg, P.H., Stehfest, E., Müller, C. (2010). The yield gap of global grain production: A spatial analysis. *Agric. Syst.* 103, 316–326. doi:10.1016/j.agsy.2010.02.004
- van Ittersum, M.K., Cassman, K.G., Grassini, P., Wolf, J., Tittonell, P., Hochman, Z. (2013). Yield gap analysis with local to global relevance—A review. *Field Crops Research* 143, 4–17. doi:10.1016/j.fcr.2012.09.009
- Williams, J.R. (1995). The EPIC Model, in: *Computer Models of Watershed Hydrology*, Water Resources Publications. Singh V.P., pp. 909–1000.

Modelling impacts of stomatal drought sensitivity and root growth rate on sugarcane yield

A. Singels – M. R. Jones – M. van der Laan

South African Sugarcane Research Institute, Private Bag X02, Mont Edgecombe 4300, South Africa.
e-mail: abraham.singels@sugar.org.za

Introduction

Crop models can be used to predict the impacts of genetic traits on crop performance for different environments. This could indicate the desirability of traits in target environments and thus aid the formulation of ideotypes. The objective of the study was to assess the impact of two genetic traits, namely potential root growth rate (RGR) and stomatal sensitivity to drought (SSD), on crop performance and yield, in order to get indications of the feasibility of using crop models to identify desirable traits for sugarcane genotypes.

Methods

The DSSAT Canegro v4.5 (Singels et al., 2008) was used to simulate crop growth of a May annual cycle of variety NCo376. Long term weather data from Mount Edgecombe, South Africa for the period 1928-2009 and two soils differing in depth and water holding capacity was used as model input. Ten low, ten medium and ten high potential environments (season X soil instances) were selected for further analysis, on the basis of simulated aerial dry mass.

Three levels were simulated for each trait by adjusting appropriate model trait parameters. Low, medium and high values of RGR were simulated by adjusting root elongation rate per unit thermal time (RERo) and the above ground partitioning fraction (AFPmax) (see Table 1). The latter regulates partitioning of assimilate to roots. Enhanced partitioning of assimilate is required to sustain enhanced RGR. SSD was emulated by adjusting a soil-plant conductivity parameter SWCON2 that regulates root water uptake and carbon assimilation.

Table 1. Low, medium and high values for trait parameters and the corresponding values for cultivar NCo376.

Trait:	Root growth rate		Stomatal sensitivity to drought
Trait parameter:	RERo (mm/(°Cd))	AFPmax	SWCON2
H	2.57	0.86	70
M	2.2	0.88	87.5
L	1.83	0.90	120
NCo376	2.2	0.88	87.5

Results and discussion

Accelerated RGR resulted in higher root mass and quicker penetration of roots down the soil profile. In a typical season, the high RGR genotype reached the profile depth at 156 days after crop start (DAS) and produced 7.6 tons/ha of roots, compared to 187 DAS and 5.9 t/ha for the low RGR genotype. The RGR trait had a very limited effect on root length density and on root water uptake, resulting in very little impact on growth processes and on yield. Early stomatal closure caused a reduction in transpiration and biomass accumulation. In a typical season, photosynthesis and expansive growth was affected more frequently and severely in the high SSD genotype compared to low SSD genotype. The average response in sucrose yield to changes in RGR and SSD for different environment types are summarized in Table 2.

Table 2. Average sucrose yield for each environment type (low, medium and high potential E) for the different levels of each trait (potential root growth rate – RGR and stomatal sensitivity root water uptake rate - SSD). The percentage yield response relative to the medium trait value is also shown.

	Sucrose yield (t/ha)			Response (%)		
	Low	Med	High	Low	Med	High
RGR:						
Low E	3.76	3.63	3.53	3.55	0.00	-2.71
Med E	9.35	9.17	9.01	2.06	0.00	-1.74
High E	14.51	14.13	13.75	2.70	0.00	-2.73
SSD:						
Low E	3.83	3.64	3.54	5.14	0.00	-2.90
Med E	9.19	9.02	8.58	1.91	0.00	-4.88
High E	14.26	14.04	13.67	1.58	0.00	-2.60

Results suggest that enhanced root growth without an associated enhanced photosynthetic efficiency will not necessarily lead to higher yields because the increased investment of carbon in roots results in less carbon being available for sucrose production. The slight improvement in crop water status because of improved water capture is not enough to counter the reduced partitioning of carbon to stalks. Results also suggest that increased stomatal sensitivity to drought is not a desirable trait for the range of environments investigated in this study. Although it led to reduced transpiration, it also caused more frequent and more severe reductions in growth and photosynthesis, leading to lower yields in low and high potential environments. This is in agreement with similar findings of Inman-Bamber et al., (2012) for sugarcane in Australia.

Conclusions

Results suggest that modelling trait impacts produces valuable information that could inform sugarcane breeding programs, but also point to shortcomings in the Canegro model that needs attention.

References

- Singels, A., Jones, M., van den Berg, M., 2008. DSSAT v4.5 Canegro Sugarcane Plant Module: Scientific documentation. SASRI, Mount Edgecombe, South Africa. pp 34.
- Inman-Bamber, N.G., Lakshmanan, P., Park, S., 2012. Sugarcane for water-limited environments: Theoretical assessment of suitable traits. *Field Crops Res* 134: 95-104

Quantification of high temperature risks and potential effect on sorghum productivity in eastern australia

*V. Singh*¹ – *C. Nguyen*¹ – *E. van Oosterom*¹ – *S. Chapman*² – *G. Mclean*³ – *B. Zheng*² – *D. Jordan*⁴ – *G. Hammer*¹.

¹ The University of Queensland, Centre for Plant Science, QAAFI, Brisbane Qld 4072, Australia.
erik.van.oosterom@uq.edu.au

² CSIRO Agriculture Flagship, Queensland Bioscience Precinct, St Lucia, Qld 4067, Australia

³ Department for Agriculture and Fisheries, Toowoomba, Qld 4350, Australia.

⁴ The University of Queensland, Centre for Plant Science, QAAFI, Warwick Qld 4370, Australia.

Introduction

Seed set of sorghum is most affected by high temperatures around anthesis (Prasad et al., 2008), but genotypic differences in the threshold temperature and tolerance to increased temperature above the threshold have been observed (Singh et al., 2015). Moreover, poor seed set under high temperature is not compensated by increased seed mass (Singh et al., 2015). Temporal and spatial variability in the frequency of occurrence of high temperatures across the sorghum belt in NE Australia, combined with genotypic differences in heat tolerance, is likely to cause complex interactions for grain yield. The aim of this study was to quantify (1) the risks of occurrence of heat stress in the sorghum production region of NE Australia, (2) the effect of such heat stress on sorghum yields, and (3) the potential role of management and genetics in minimising the adverse effects of heat stress on grain yield.

Materials and Methods

Long term (59 years) weather records of six locations across the Australian sorghum belt were used for an environment characterisation of the probability of occurrence of heat stress. These records were also used as input into the APSIM-sorghum simulation

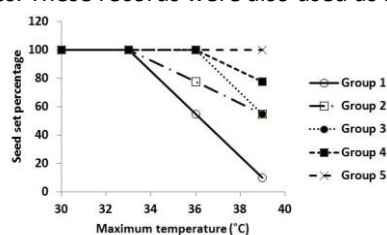

Figure 1. Parameters for the response of seed set to maximum daily temperature of five genotypes used in the simulations. Genotypes range from highly susceptible (Group 1) to highly tolerant (Group 4), based on differences in the threshold temperature or tolerance above the threshold. Group 5 is control that is not affected by high temperatures at all.

model, which has been recently updated to incorporate the latest scientific knowledge on the physiology of crop growth and development (Hammer et al., 2010). The model

was modified to capture the effects of heat stress on grain set (Singh et al., 2015) and a standard genotype with five different parameters settings for the response of seed set to maximum temperature were used in the simulations (Fig. 1).

Results and Discussion

The most common incidence of heat stress around anthesis of sorghum was the occurrence of individual days with maximum temperatures between 36-38°C, rather than continuous periods with sustained high maximum temperatures. As maximum temperatures were around the threshold for high temperature tolerance, selection for a high threshold (Fig. 1) was generally sufficient to minimise any adverse effects on grain yield (Fig. 2). However, predicted increases in temperature over the coming decades are likely to negate this, making selection for increased tolerance above the threshold also important. Manipulation of sowing dates was ineffective in minimising the effects of high temperature on grain yield, unless sowing was extremely late.

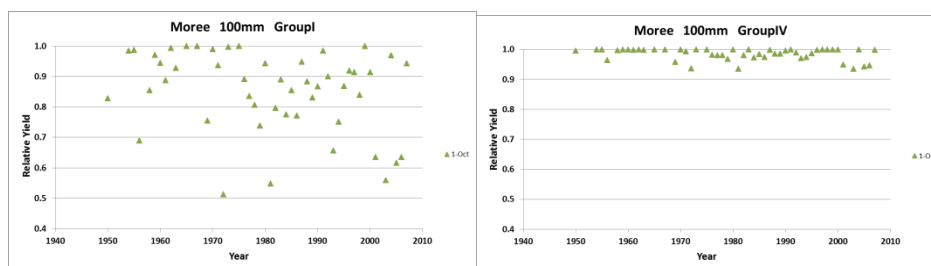

Figure 2. Reduction in simulated yield relative to the control (Group 5, Fig. 1) due to high temperature effects for 1 October sowing at Moree with 100mm available soil water with either a susceptible (Group 1 - left panel) or tolerant (Group IV- right panel) genotype.

Conclusions

Results indicate that genetic improvement is likely to provide the best prospects to mitigate adverse effects of heat stress on grain yield.

Acknowledgements

The modelling work was made possible by the significant contributions of growers through the support of the GRDC, Australia. The biological research on high temperature effects that underpinned the modelling was conducted as part of an Australian Federal Government Department of Agriculture Forestry and Fisheries funded project on Climate Ready Cereals.

References

- Hammer, G.L., E. van Oosterom, G. McLean et al., (2010). *Journal of Experimental Botany* 61: 2185-2202.
- Prasad P.V.V. S.R. Pisipati, R.N. Mutava et al., (2008). *Crop Science* 48: 1911-1917.
- Singh, V., C.T. Nguyen, E.J. van Oosterom et al., (2015). *Field Crops Research* 171: 32-40.

Mapping rainfed rice cultivation under future climate change scenarios

*K. Singh*¹ – *C. J. McClean*² – *P. Bölker*³ – *S. E. Hartley*⁴ – *J. K. Hill*^{1,4}

¹ Biology Department, University of York, York, YO10 5DD, U.K.

² Environment Department, University of York, York, YO10 5DD, U.K.

³ Stockholm Environment Institute-York, Environment Department, University of York, York, YO10 5DD, U.K.

⁴ York Environmental Sustainability Institute, University of York, York, YO10 5DD, UK

Introduction

More than 80% of rice is grown during the summer monsoon season (June – September) in India and much of this rice is grown under rainfed conditions. Increases in temperature and greater variability in precipitation are projected for the future (IPCC, 2013), which could make these areas unsuitable for growing rainfed rice. Here, we model the current distribution of rainfed rice using a climate envelope modeling (CEM) approach (Elith et al., 2006). We also make future projections by incorporating future climate change scenarios (Vuuren et al., 2011) into the model, which highlight areas that may become unsuitable for rainfed rice cultivation in future.

Materials and Methods

We collected data on average (1998-2013) area under rainfed rice cultivation (ha) for the summer monsoon season at district level (~ 5730 km²) for India, and converted data to a gridded dataset (~18 km grid square resolution). We assumed that grids which had ≥ 15% of total land area under rainfed rice corresponded to ‘presences’, and the remaining grids were ‘absences’. Our modelling used four predictors that are biologically important to rice: moisture index (June-September), average minimum temperature (October-November), average maximum temperature (June-September) and rainfall (October-November). We followed a CEM approach and ran an ensemble of models to generate predictions about the future distribution of rainfed rice growing areas (Thuiller et al., 2003).

Results and Discussion

The ensemble model output predicted the current distribution of rainfed rice with very good accuracy (AUC = 0.94; Fig 1). In future, these models project that in areas that currently grow rainfed rice (presences), the mean probability of rainfed rice presence will decline by 2050 under IPCC RCP 8.5 future scenario (from an overall mean probability of presence of 0.54, to 0.44) corresponding to 62% of grids becoming less suitable (i.e. decreased probability) for growing rainfed rice in future.

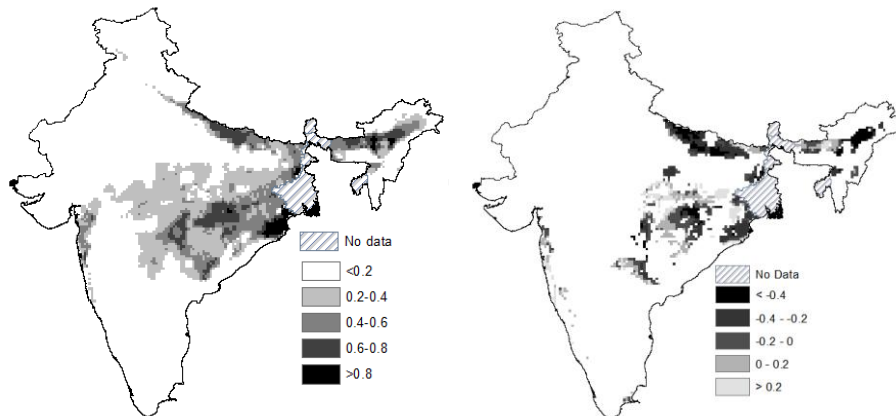

Figure 1. (Left) Modelled current distribution of rainfed rice, AUC = 0.94; higher values indicate higher probability of presence of rainfed rice cultivation. (Right) Change in probabilities of rainfed rice presence (future probability – current probability) for 2050 under RCP 8.5 for grids where rainfed rice is cultivated ($\geq 15\%$ criteria). Negative values imply areas becoming climatically less suitable for growing rainfed rice.

Conclusions

The results suggest that more than half of the current rainfed rice areas may become climatically less suitable in the future. There are also some new areas that are projected to become climatically suitable, although this does not imply farmers would be able to convert these areas to rice considering other socio-economic challenges. These results projecting loss of rainfed areas highlight the vulnerability of farmers to altered precipitation patterns.

Acknowledgements

This work was funded by the UK Biotechnology and Biological Sciences Research Council, the UK Department for International Development and (through a grant to BBSRC), the Bill & Melinda Gates Foundation, under the Sustainable Crop Production Research for International Development (SCPRID) programme, a joint initiative with the Department of Biotechnology of the Government of India's Ministry of Science and Technology.

References

- Elith J, Graham CH, Anderson RP, Dudík M, Ferrier S, et al., (2006). Novel methods improve prediction of species' distributions from occurrence data. *Ecography* 29:129–51
- IPCC (2013): *Climate Change 2013: The Physical Science Basis. Contribution of Working Group I to the Fifth Assessment Report of the Intergovernmental Panel on Climate Change* [Stocker, T.F., D. Qin, G.-K. Plattner, M. Tignor, S.K. Allen, J. Boschung, A. Nauels, Y. Xia, V. Bex and P.M. Midgley (eds.)]. Cambridge University Press, Cambridge, United Kingdom and New York, NY, USA, 1535 pp.
- Thuiller, W. (2003) BIOMOD – optimizing predictions of species distributions and projecting potential future shifts under global change. *Global Change Biology*, 9, 1353–1362.
- van Vuuren D, Edmonds J, Kainuma M, Riahi K, Thomson A, Hibbard K, Hurtt G, Kram T, Krey V, Lamarque JF, Masui T, Meinshausen M, Nakicenovic N, Smith S, Rose S (2011) The representative concentration pathways: an overview. *Climatic Change*, 1–27

Quantification of forage maize yield gap in Alborz province of Iran by help of crop simulation modeling

S. Soufizadeh – A. Mirebrahim – J. Shirmohammadi – R. Deihimfard – J. Kambouzia – K. Khoshbakht

Department of Agroecology, Environmental Sciences Research Institute, Shahid Beheshti University, Tehran, Iran. Corresponding author email: a.mirebrahim@mail.sbu.ac.ir (A. MirEbrahim)

Introduction

Evaluation of and narrowing crop yield gap is among the most important challenges in agriculture. Yield gap is defined as the difference between the yield potential (YP) and the farmers' actual yield (Lobell et al., 2009). Crop models are valuable tools to predict YP of a crop in a given environment, which is the first step toward estimation of yield gap (Manschadi et al., 2010). Crop models could play an important role in identification of factors causing yield gap. The objectives of the present study are to determine the YP and yield gap of forage maize by the help of crop simulation modeling and to analyze responsible factors causing the gap.

Materials and Methods

An experiment was conducted in Alborz province of Iran in 2012. The region has a semi-arid climate with hot summers and mild winters. Fifty maize fields were chosen in a manner to provide a good coverage over the province. The fields were monitored during the growing season by means of destructive samplings and filling in the questionnaire to gather required data for running the crop model and analyzing the yield gap. Daily weather data for the whole growing period was obtained from Iranian Meteorological Organization. At the beginning of the growing season, soil sampling was done in each field to measure physicochemical characteristics. Management information/data were gathered through face to face interview with farmers throughout the growing period of the crop. Crop destructive samplings were done at flowering and final harvest where various crop attributes such as phenology, leaf area index (LAI) and biomass were recorded/measured. Agricultural Production Systems simulator (APSIM) was employed to predict the YP of forage maize in the province in the absence of any abiotic and biotic stresses. APSIM-Maize was previously calibrated for maize cultivar OSSK602 (Soufizadeh et al., 2011). The common variety in the region is KSC704. The maize cultivar OSSK602 is ranked in the same maturity group as cultivar KSC704 according to Chokan and Hasanzadeh Moghaddam (2010). Thus, the genetic parameters relevant to OSSK602 were applied to KSC704. Yield gap at various levels was then calculated and analyzed in terms of crop and agronomic perspectives.

Results and Discussion

Results indicated that the simulated YP for forage maize in Alborz province was 2400 g m⁻² (Fig. 1). Based on this result, the yield gap between YP and yield at research institute, between YP and the leading farmers, and between YP and average farmers in the region were 540, 111 and 1262 g m⁻², respectively (Fig. 1). It is obvious that quite

large gap exists in the province and there is still great possibility to increase forage yield. In spite of the fact that the performance of a few farmers were good enough to get close to 85% YP (exploitable yield), none of them could reach the maximum yield simulated by the crop model.

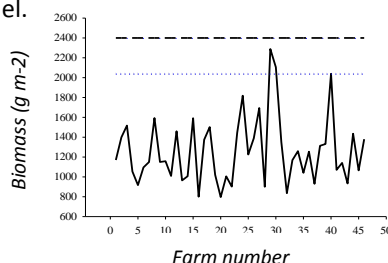

Figure 1. Simulated YP (---), exploitable yield (.....), and actual farmer's yield (—) Alborz province.

Further analysis of results indicated that plant density and LAI were among the most important factors causing such a large yield gap (Fig. 2). Sub-optimum plant density in the studied fields were mainly due to low organic matter content of soil which resulted in inappropriate establishment of maize seedlings. This resulted in lower LAI and further decrease in crop growth rate, which ultimately reduced total biomass. Thus, increasing soil organic matter on one hand and application of quality seeds on the other hand are among the most promising solutions to narrow yield gap in this region.

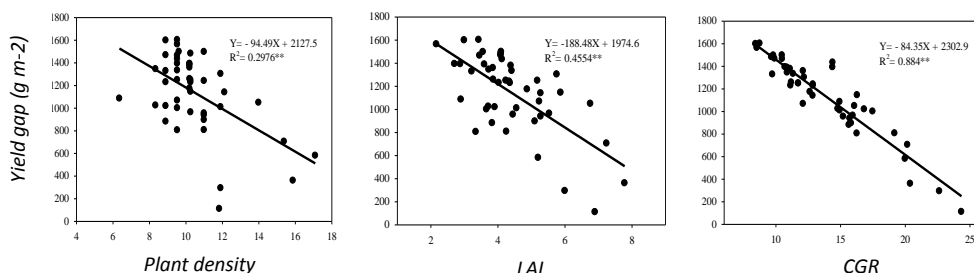

Figure 2. The relationships between maize yield gap and plant density, LAI and CGR in Alborz province.

Conclusions

Overall, the results of the present study revealed that large gaps exist in forage maize in Alborz province which were mainly due to agronomic and management factors. These factors imposed their impacts on biomass yield through affecting LAI. Moving toward conservation tillage, which remains higher portion of crop residue on the soil surface, is necessary to decrease the observed yield gap.

References

Chokan, R., and H. Hasanzadeh Moghaddam (2010). Journal of Agroecology, 2: 277-286.
 Lobell, D.B., K.G. Cassman, and C.B. Field (2009). Annu. Rev. Environ. Resour, 34: 179-204.
 Manschadi, A., S. Soufizadeh, and R. Deihimfard (2010). Proceedings 11th Iranian Crop Science Congress, July 24-26, Tehran, Iran. pp. 234-247.
 Soufizadeh, S. (2011). Ph.D. Dissertation. Tarbiat Modarres University, Tehran.

Developing algorithms for modelling the dynamics of N balance in maize in a gene-to-phenotype context

*S. Soufizadeh*¹ – *E. van Oosterom*^{2,3} – *G. Mclean*⁴ – *G. L. Hammer*^{2,3}

¹ Department of Agroecology, Environmental Sciences Research Institute, Shahid Beheshti University, G.C., Tehran, Iran. Email: s_soufizadeh@sbu.ac.ir

² The University of Queensland, School of Agriculture and Food Sciences, Brisbane, Qld 4072, Australia.

³ The University of Queensland, Queensland Alliance for Agriculture and Food Innovation, Brisbane, QLD 4072, Australia

⁴ Agri-Science Queensland, Department of Employment, Economic Development & Innovation, 203 Tor Street, Toowoomba, Qld 4350, Australia

Introduction

Current crop models have to be improved in algorithm structure and input parameters to achieve the level of physiological rigour needed for using modelling in a gene-to-phenotype context (Hammer et al., 2010). This requires a paradigm shift toward modeling causes of physiological processes that dynamically generate their emergent consequences, rather than using approaches that mathematically describe the consequences themselves. Past efforts on modelling N dynamics of crops have often been empirical, lacking the physiological basis to capture genotype and environmental effects in a dynamic manner. A common concept for quantifying N demand has been based on relating N taken up by the crop to growth in aerial biomass via critical stover %N. However, that approach does not capture the dynamics of the underlying morphology and physiology and thus limits the ability to represent genotypic variation realistically. Approaches based at organ level and using derived estimates of specific leaf nitrogen (SLN) as a central variable defining the N status of the crop can address this shortfall without introducing undue complexity. The objective of the present study was to revise the APSIM-maize routines to incorporate improved approaches to the modelling of N responses in maize.

Materials and Methods

The current maize module of Agricultural Production Systems sIMulator (APSIM) that was originally written in FORTRAN, was redesigned and programmed in object-oriented C++. A new algorithm for N dynamics was developed where demand for N by individual organs was based on their size and met in hierarchical fashion, such that N allocation to organs became a function of genotypic differences in organ size and environmental differences in N supply. SLN becomes a central derived trait in linking the underlying physiological processes to crop growth as leaves represent the main sink for N prior to anthesis. After anthesis, grains are the major sink for N and their demand is the product of grain number and N demand per grain. Parameterization of the model was performed using three field experiments conducted at Gatton, Australia from 1999 to 2001. Three rates of N were applied in each experiment ranging between

severe N and no N stress. Model predictions were evaluated using a comprehensive set of field experiments conducted in Australia and elsewhere.

Results and Discussion

Parameterization of the model showed that the critical SLN required for maintaining the maximum rate of dry matter accumulation was 1.1 g m^{-2} . Results indicated that the new N model based on organ demand, rates of retranslocation, and N uptake could successfully predict maize responses to N with simulations of crop attributes in close agreement with observed values for a range of N conditions (Fig. 1). Severe N stress strongly restricted maize growth and yield and the model could capture these effects credibly. As a result of severe N stress, leaf N content halved compared to the no N stress condition, resulting in lower SLN and subsequent reduction in leaf area index and radiation use efficiency of the crop.

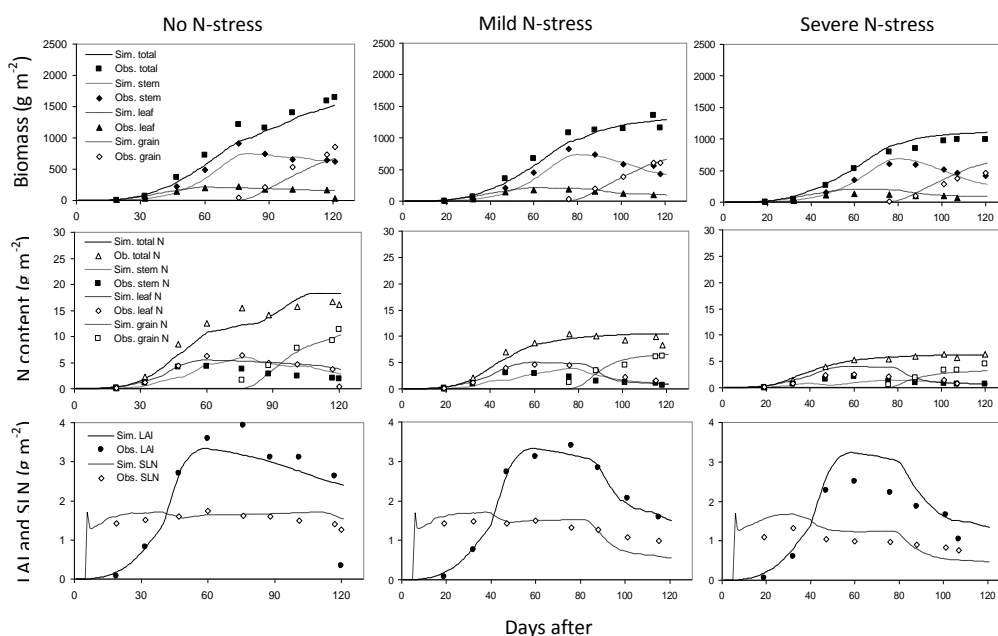

Figure 1. Simulated crop characteristics throughout the crop growing period (lines) compared to observed values (symbols) for different N treatments.

Conclusions

Overall, new developed N model has considerable capacity to examine consequences of key genotypic differences in N dynamics of maize.

References

Hammer, G.L., E. van Oosterom, G. McLean et al., (2010). J. Exp. Bot. 61, 2185-2202.

Climate change impact under climate scenarios on maize yield in Ghana

A. K. Srivastava – G. Zhao – C. M. Mboh – T. Gaiser – F. Ewert

Institute of Crop Science and Resource Conservation, Katzenburgweg 5, D-53115, Bonn, Germany.
e-mail: amit.srivastava@uni-bonn.de

Introduction

Africa as a whole is one of the most vulnerable continents in the face of climate change due to its high exposure and low adaptive capacity. In the coming decades, global climate change will have an impact on all sectors of the global economy. But most impacts will fall on the agricultural sector, creating food insecurity and heightened water stress, most especially in the developing world (Nelson et al., 2009). Detailed climate change impact assessment studies on maize are scarce for the tropical humid forest zone of Central Ghana, constituting a major maize production area in the country. In view of this background, the objective of this study was set to make an impact assessment of climate change scenarios on potential productivity of maize using crop growth model based on three General Circulation Models (GCM), two Representative Concentration Pathways (RCP_s) for two time scenarios (near future and end century) under A1B emission scenario in central Ghana which is regarded as a major maize producing area in the country. A1B emission scenario proposed by the Special Report on Emissions Scenarios (SRES) was chosen as one of the most impacting due to a rise in temperature; hence this evaluates the potential impact of one of the most critical possible future climates.

Materials and Methods

A gridded data set was built; covering the two major maize producing regions of Ghana namely, Ashanti and Brong-Ahafo. In this study the time-slices 2000, 2030 and 2080 were chosen to represent the baseline and future climate, respectively. Future climate scenario analysis was based on reference time slice of 2000 (based on thirty years daily data of 1971-2000). Projections of future climate were obtained using CMIP5 and the RCP_s for carbon emissions currently in use by the IPCC Fifth Assessment Report. Future climate projections were created using the 'delta' method, in which the mean monthly changes (from baseline) for RCP_s 4.5 and 8.5 for near future and End century time slices centred around 2030 and 2080, respectively, were applied to the daily baseline weather series. The GCMs used in this study are i) GFDL-ESM2M; ii) GISS-E2-H; and iii) HadGEM2-ES. Within the SIMPLACE modelling framework, a combination of the LINTUL5 crop model with a detailed soil water balance model (SLIM) was used to simulate the yield of dominant maize, a long-cycle variety ('obatanpa'), with prevailing agri-management practices comprising of low fertilizer application rate and no irrigation.

Results and Discussion

As per the output of the climate models, there is a tendency of improvement in maize yields in the study region within the time slice of 2030 and 2080. The variation in yield increase ranges from 24.2 to 46.3 % depending on the climate model and the RCPs analyzed. However, the increase in yield is more pronounced with the output of HadGEM2-ES which anticipates highest increase in temperature (by almost 2°C) compared to baseline. Simulations indicate delay of the maturity date, consequently elongating the growth periods under increased air temperatures leading to increased grain filling period and higher yields.

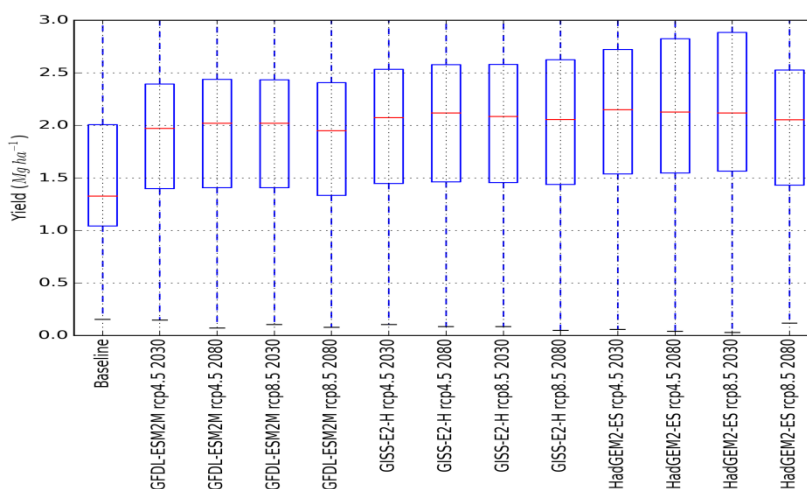

Figure 1 Maize yield for different GCM and time slices.

Conclusions

This study concludes that the impact of climate change under A1B IPCC SRES scenarios on maize production in the central Ghana is significant and positive. There is an increase in maize yield ranging from 24 - 46% across all the GCMs and RCPs analyzed.

Acknowledgements

Work carried out under the project BiomassWeb within the GlobeE research programme. Funding by Federal Ministry of Education and Research (BMBF) of Germany is highly acknowledged.

References

- Nelson, G.C., M.W. Rosegrant, J. Koo et al., (2009). Climate change impacts on agriculture and costs of adaptation. Research report, International Food Policy Research Institute, Washington, DC.
- Wolf, J., P. Reidsma, B. Schaap, et al., (2012). Assessing the adaptive capacity of agriculture in the Netherlands to the impacts of climate change under different market and policy scenarios (AgriAdapt project). ISBN/EAN 978-90-8815-051-7.

Development of a modelling solution targeting the simulation of rice cropping system: the role of model composition

T. Stella – S. Bregaglio – R. Confalonieri

Department of Agricultural and Environmental Sciences, University of Milan, via Celoria 2, 20133 Milan, Italy, tommaso.stella@unimi.it

Introduction

Simulation modelling in agriculture bases on models, which are sets of interlinked equations abstracting the bio-physical processes underlying the cropping system. These are commonly called sub-models and derive from a multi-domain research (e.g., crop physiology, soil science) which often produces results at process level. We can therefore refer to agricultural models as modelling solutions (MSs), meant as the result of sub-models composition. The adoption of a software design reflecting the granular nature of agricultural research favors model development, inter-comparison (Donatelli et al., 2014) and reuse (Stella et al., 2015), thus reducing the gap between scientific knowledge and its formalization into simulation models. This paper presents the implementation of a MS to simulate the functioning of paddy rice cropping system. The MS responds to alternate farmer management strategies, considering the impact of flooding events and fertilizations on soil carbon and nitrogen dynamics and then on crop growth and development. Main outputs are rice yield formation and the dynamic of greenhouse gases emissions (CH₄, N₂O, CO₂). The MS is designed with a fine granularity to maximize the possibilities of improvement and further extensions.

Materials and Methods

The MS is composed by models implemented in independent software components, each collecting alternate approaches for the simulation of specific processes (Table 1).

Table 1. Domains, simulated processes and software components implemented in the modelling solution.

Domain	Software component	Simulated processes
Crop	UNIMI.CropML	Crop growth/development, water and nitrogen uptake
Management	CRA.Agromanagement	Sowing, harvest, irrigation and fertilization
Meteorology	CRA.Clima	Hourly air temperature and solar radiation, reference ET
Soil CN	UNIMI.Crono	C and N transformations in soil, gas and solutes transport
Soil water	UNIMI.SoilW	Water infiltration and redistribution among soil layers
Soil temperature	UNIMI.SoilT	Surface and soil temperature at different soil depths

The design of the components follows the BioMA software framework (<https://en.wikipedia.org/wiki/BioMA>): algorithms reproducing specific processes are implemented in discrete units (i.e., simple strategies), which are composed into objects of increasing complexity (i.e., composite strategies). This process ends with a composite strategy representing a model of the bio-physical domain of interest, realized as a possible combination of alternate sub-models. The MS handles the

communication among components at run time via data structures storing all the input/output variables describing the domain.

Sample runs were performed in the 2014 cropping season in the Northern Italian rice area. The simulated management (sowing, water application and nitrogen fertilization) is in line with local farmer practices.

Results and Discussion

The integration of models of the main processes involved in the rice cropping system allowed to achieve a multi-domain dynamic simulation. Figure 1 presents a graphical output showing the capability of the MS to respond to the complex interactions between the components of the system.

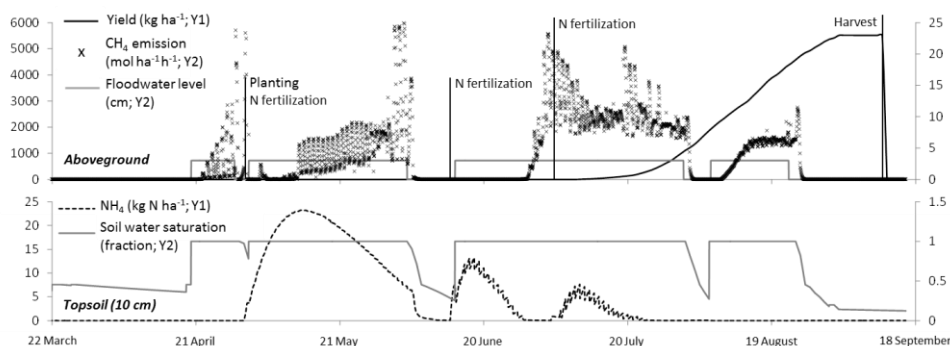

Figure 1. Outputs of a sample simulation performed in the 2014 rice cropping season

Rice crop is sown on May 1st and reaches flowering in August. Ripening period ends in September, with a final yield around 5.5 t ha⁻¹. Three fertilization events are applied – leading to an increase of nitrogen content in the topsoil – followed by flooding. The CH₄ emission dynamics strongly depend upon water management strategies.

Conclusions

The adoption of a granular design in the development of cropping system models presents clear advantages compared to monolithic software units. The possibility of setting up new MSs through composition and testing alternate models for the same process are prominent. The MS presented here is a concrete demonstration of these concepts, and lays the basis for an in-silico investigation of the genotype × environment × management interactions underlying the rice cropping system.

References

- Donatelli, M., S. Bregaglio, R. Confalonieri et al., (2014). *Environmental Modelling and Software*, 62: 478–486.
 Stella, T., C. Francone, S. S. Yamaç et al., (2015). *Computers and Electronics in Agriculture*, 113: 193–202.

Identifiability analysis of a grass growth model

T. de Swaef – P. Lootens – I. Roldan-Ruiz

Plant Sciences Unit, Institute of Agricultural and Fisheries Research, Caritasstraat 21, B-9090 Melle, Belgium,
tom.deswaef@ilvo.vlaanderen.be

Introduction

Process-based crop models have been identified to enable dissection of complex phenotypes into more simple and heritable traits (Tardieu and Tuberosa, 2010). For crop models to be suitable for use in studying genotype-by-environment-by-management (GxExM) interactions, they need a certain degree of complexity (Hammer et al., 2006). As such, parameters of such detailed models could be seen as genotypic or varietal coefficients (Yin and van Laar, 2005), which are less dependent on environmental conditions and better correspond to the true value of the genotype or variety. However, such detailed models contain an extensive set of parameters, which can only be estimated correctly if sufficient data are present. Data collection, however, is often laborious and expensive, and should therefore be carefully planned. Identifiability analysis identifies model parameter subsets which could be independently estimated for a given amount of available experimental data.

The aim of the present paper was therefore to indicate how identifiability analysis could be used to determine the frequency with which experimental observations should be conducted to ensure independent parameter estimation. More specifically we performed an identifiability analysis on the LINGRA model (Schapendonk et al., 1998) using different hypothetical observation intervals.

Materials and Methods

The LINGRA model code (Schapendonk et al., 1998) was implemented in the PhytoSim software (Phyto-IT, Mariakerke, Belgium), which is built for model simulation, calibration, and sensitivity and identifiability analysis. Daily weather data (maximum and minimum daily temperature, radiation sum, average wind speed, average relative humidity, precipitation) were collected for 13 years (1995 to 2007) from a weather station in Melle, Belgium (50°58'49"N 3°48'49"E) and used as input to the model. Parameter values were the default LINGRA values for perennial ryegrass (Schapendonk et al., 1998). The identifiability analysis is built in PhytoSim following the method of Brun et al., (2002). In this study, a set of sixteen physiological parameters was taken into account as source components and the dry matter yield as a target variable for which data could be collected. For each year, identifiable parameter subsets were generated for eight different hypothetical data collection intervals: every day, every 10, 20, 30, 40, 50, 60 days, and 4 times per year, corresponding to typical harvest periods. The size of the largest parameter subset that was still identifiable was recorded for the eight collection intervals for each year.

Results and Discussion

Figure 1 demonstrates that the number of independently estimable model parameters decreases when the number of experimental observations decreases. At present, dry matter yield data is only collected at time of harvest, resulting in a limited number of estimable parameters (between 3 and 5 depending on the year). Increasing the frequency of dry matter data collection to once every 20 days would allow to estimate 6 to 7 parameters independently.

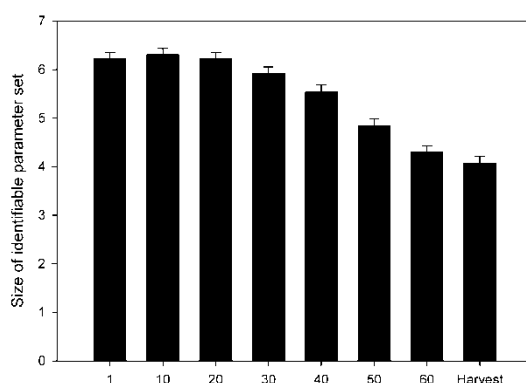

Figure 1. Average size of largest identifiable parameter sub-set for the different hypothetical data collection intervals. Error bars indicate the standard error over the different years ($n = 13$). 1, 10, 20, 30, 40, 50 and 60 indicate the data collection interval in days, *Harvest* indicates 4 times per year at hypothetical harvest times.

This approach could as such be used to plan UAV flights over specific experimental fields to ensure the required amount of data for model calibration. Furthermore, the (frequency of) other observations could also be included to examine the effect on the number of parameters that could be independently estimated.

Conclusions

Independent estimation of process-based crop model parameters is crucial to study GxExM interactions, since these parameters represent genotypic or varietal coefficients. The use of identifiability analysis prior to data collection ensures proper parameter estimation and can contribute to a smart planning of the employment of available resources.

References

- Brun, R., M. Kuhni, H. Siegrist et al., (2002). *Water Research*, 36: 4113-4127.
- Hammer, G., M. Cooper, F. Tardieu et al., (2006). *Trends in Plant Science* 11: 587–593.
- Schapendonk, A.H.C.M., W. Stol, D.W.G. van Kraalingen et al., (1998). *European Journal of Agronomy*, 9:87-100.
- Tardieu, F. and R. Tuberosa (2010). *Current Opinion in Plant Biology*, 13: 206-212.
- Yin, X. and H.H. van Laar (2005). Wageningen Academic Publishers, Wageningen, 155 pp.

Comparative model analysis of various sparing measures intended to crop production sustainability by “APEX-AGROTOOL” simulation system

*A. Topaj*¹ – *V. Badenko*² – *V. Terleev*² – *S. Medvedev*¹

¹ Laboratory of Agroecosystem Simulation, Agrophysical Research Institute, 195220, 14 Grazhdansky pr., Saint-Petersburg, Russia, alex.topaj@gmail.com

² Civil Engineering Institute, Peter the Great St.Petersburg Polytechnic University, Russia, 195251, St.Petersburg, Polytechnicheskaya, 29.

Introduction

Maintaining or even increasing the fertility of agricultural landscapes during their active agricultural use is one of the most important scientific problems in theoretical agricultural science. In recent years scientific community reinforced the efforts to achieve agro-landscape environmental sustainability instead of maximum productivity. It becomes especially important under global changes expected. The paper presents author efforts to develop and improve the integrated system of crop simulation “APEX-AGROTOOL” for analysis and investigation of various sparing measures intended to crop production sustainability.

Materials and Methods

AGROTOOL is a mechanistic crop model developed to estimate the agrometeorological crop state, to forecast crop yield, as well as to support agricultural decision making and analyze the sowing, irrigation, fertilization and harvesting management (Poluektov et al., 2002). In turn, APEX (Automation of Polivariant EXperiments) is a software system developed for design and performing of multi-factor computer experiments with arbitrary dynamic crop models. It encapsulates two basic functionalities: versatile repository of external crop model descriptors and generic environment for model polyvariant analysis. The latter means the designing and preparation of multivariate computer case study, performing the model runs in batch mode and applying advanced procedures of statistical treatments for results obtained (Medvedev and Topaj, 2011).

AGROTOOL as a comprehensive ecologically oriented crop model (Badenko et al., 2014) coupled with APEX which supports cyclical scheme of model computation (taking into account crop rotation) became an effective tool of analyzing long-term trends of indicators of soil fertility and other parameters of the environmental sustainability of agricultural landscapes. “APEX-AGROTOOL” integrated simulation system allows the conventional agro-technics as well as additional sparing measures intended to crop production sustainability to be investigated (Medvedev et al., 2015).

Results and Discussion

Imitation complex “APEX-AGROTOOL” was used to perform a series of model experiments in order to obtain estimates of the relative effectiveness of different measures of prolonged action, which are aimed to improving the ecological stability of the agricultural landscape and conservation of soil fertility, taking into account the possible climate change as a background. Numerical experiments have been designed for several alternative schemes of different types of crop rotation: food, feed and energy (spring and winter cereals, potatoes, canola, corn for silage) in a continuous cycle of vegetation seasons. The following methods were considered as measures of the maintaining the main indicators of the ecological state of the agro-ecosystem within the boundaries of its stable functioning and soil fertility reproduction:

- a) Selection of the optimal sequence in crop rotation from a limited crop set, i.e. the planning the schemes of crop change order using the methods of combinatorial optimization;
- b) Transition to the sparing harvesting technologies for avoiding unproductive removing of aboveground crop residues having no economic value (straw, etc.)
- c) Cultivation of the intermediate “green manure” catch crops during non-vegetation period of the main crop rotation for soil carbon sequestration; furthermore usage the legumes for this purpose can increase the level of labile soil nitrogen through symbiotic nitrogen fixation process;
- d) Extensive usage of organic fertilizer in the form of cattle manure.

The results of a comparative analysis of the measures considered in terms of guaranteed productivity and sustainability of agro-ecosystems are presented.

Conclusions

The results obtained prove, that total abilities of developed integrated environment «APEX-AGROTOOL» cover completely the challenges of mid-term forecasting of agro-landscape sustainability and, therefore, it can be effectively used as a tool of model-oriented long-term analysis of different crop rotation practices in land use.

References

- Badenko, V., V. Terleev, A. Topaj (2014). Applied Mechanics and Materials, 635-637: 1688-1691.
- Medvedev, S. and A. Topaj (2011). IFIP Advances in Information and Communication Technology, 359: 295-301.
- Medvedev, S., A. Topaj, V. Badenko et al., (2015). IFIP Advances in Information and Communication Technology 448: 252-261.
- Poluektov, R.A., S.M. Fintushal, I.V. Oparina et al.,(2002). Arch. Acker- Pfl. Boden. 48: 609-635.

Spring Barley Mixtures – Do they outperform single varieties?

C. F. E. Topp – S. P. Hoad

Crop and Soils Systems, Scotland's Rural College, West Mains Rd, Edinburgh, EH9 3JG

Introduction

Crop resilience is defined as the ability to maintain high yield despite environmental disturbance; it contributes to stability of crop performance, in terms of an expected yield and the consistency of grain in any given environment. In ecological systems it is well established that resilience is increased through biodiversity in structure and functional properties (Loreau & Mazancourt, 2013).

Monocultures (of pedigree pure lines) are the most commonly used genetic structure in wheat and barley, in which a crop's buffering capacity against a fluctuating environment is dependent on intra-genotypic compensation ability. The concept of diversity has been introduced to cropping systems as a way to enhance yield stability by growing of cereals as blends (Finckh et al., 2000; Swanston et al., 2005; Newton et al., 2011).

Our research considers how diversifying crop structure as cultivar blends (i.e. inter-genotypic effects) confers enhanced complementation and compensation among different plant neighbours. Individual genotypes are hypothesised to contribute to a group effect that is more than the sum of the individual components. For example, cultivar blends provide functional diversity that limits pathogen and pest expansion thus stabilizing yields under disease pressures (Finckh et al., 2000). This paper reports an initial analysis to assess the relative effect of seed rate and fungicide treatment on the yield of five cultivars compared to that of four-way and five-way blends.

Materials and Methods

The malting cultivars Optic, Oxbridge, Riveriera, Westminster and Wicket were grown as pure stands and in all five possible four-component mixtures, and the five component mixture in trials of three replicates in 2007 and 2008. The trials were grown at two sites in eastern Scotland, in Lanark and Dundee. In 2008, there was an additional site at Perth. The treatments were a low and a standard seeding rate and with (1) and without fungicide (0). The yield data was analysed using REML procedure in Genstat (16.1).

Results and Discussion

The results indicate that seed rate ($p < 0.001$) and the interaction between fungicide and component mixture ($p=0.009$, $sed = 0.287$) had a significant effect on yield. The yield was 5.25 t ha^{-1} and 6.17 t ha^{-1} ($sed 0.092$) for the low and the standard seed rates. In general, the fungicide treated component mixtures were higher yield than the component mixtures receiving no fungicide.

Mixtures performed as well or better than single varieties when no fungicide was applied to the crop. The single varieties of Optic and Oxbridge have lower yields than the other single varieties or the mixture when the fungicide was applied to the crop (Fig 1.). Regardless of whether the crop was grown as a blend or a single cultivar, the fungicide treatment increased yield by approximately 12%.

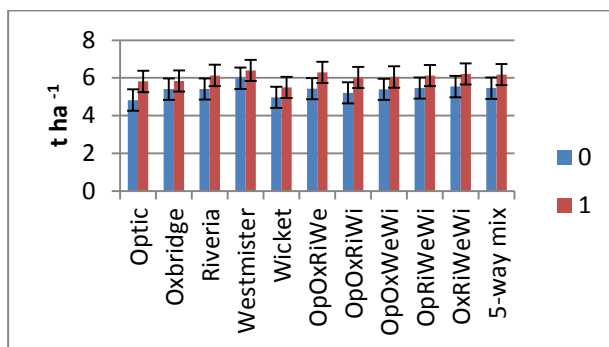

Figure 1. Grain yield for component mixtures (0= no fungicide, 1= fungicide). Error bars = lsd

Conclusions

In this case the four way and five way blends performed as least as well as the single cultivars. With the EU legislation of fungicides, there is increasingly pressure to find alternative to fungicides. The results of this study show that blends tend to perform better than some single cultivars. Some cereal sectors e.g. feed crops, distilling or biofuel crops are using cultivar blends in practice, whilst others e.g. milling wheat or malting barley have concerns about negative impacts of increased heterogeneity within the crop and in harvest bulks. The next steps in the analysis are to assess the stability of the yield of the blends and the cultivars across a range of conditions.

Acknowledgements

The authors would like to acknowledge the funding of the Scottish Government.

References

- Finckh, M.R., Gacek, E.S., Goyeau, H., Lannou, C., Merz, U., Mundt, C.C., Munk, L., Adziak, J., Newton, A.C., de Vallavieille-Pope, C. and Wolfe, M.S. (2000) Cereal variety and species mixtures in practice, with emphasis on disease resistance. *Agronomie*, 20:813–837
- Loreau, M. and Mazancourt, C., de (2013) Biodiversity and ecosystem stability: a synthesis of underlying mechanisms. *Ecological Letters* 16: 106–115.
- Newton, A.C. and Guy, D.C. (2011) Scale and spatial structure effects on the outcome of barley cultivar mixture trials for disease control. *Field Crop Research*, 123: 74-79.
- Swanston J.S., Newton, A.C, Hoad, S.P. and Spoor, W. (2005) Barleys Grown as Cultivar Mixtures Compared with Blends Made Before and After Malting, for Effects on Malting Performance. *Inst. Brew.*, 111(2): 144-152.

Use of crop modelling to assess climate risk management for family food self-sufficiency in southern Mali

B. Traoré¹– K. Descheemaeker²– M. T. van Wijk³– M. Corbeels⁴– I. Supit⁵ – K. E. Giller²

¹ Institut D'Economie Rurale (IER), Programme Coton, Station de Recherche Agronomique de N'Tarla Mali, (boubasiditraore@yahoo.fr),

² Wageningen University, Plant Production Systems, The Netherlands,

³ Sustainable Livestock Futures, International Livestock Research Institute (ILRI),

⁴ Centre de Coopération Internationale en Recherche Agronomique pour le Développement (CIRAD),

⁵ Wageningen University, Earth System Science and Climate Adaptive Land Management

Introduction

Climate change will adversely affect food production in developing countries where a large fraction of the population already faces food insecurity (Lobell and Burke, 2008). This study aimed to better understand future climate change, its impact on crop production and the adaptation options in southern Mali. We quantified the consequences for food self-sufficiency of different types of smallholder farmers.

Materials and Methods

We used long-term time series of future climate data for the Sudano-Sahelian zone of Mali coupled with the Agricultural Production Systems sIMulator (APSIM) model to analyse climate change impacts on future cereal production. We analysed changes for the 4.5 Wm⁻² and 8.5 Wm⁻² radiative forcing scenarios (rcp4.5 and rcp8.5) and their effects on maize and millet yield. We used data on maize and millet from a field experiment conducted over three consecutive growing seasons from 2009 to 2011 at N'Tarla (Traore et al., 2014). The impact of future climate change on smallholder family food self-sufficiency was evaluated based on the balance of total energy produced and required at the household level. For the farm type adaptation options we assumed that the large farm type would apply the recommended fertilizer rate and keep the current early planting practice. The medium and small farm types would also apply recommended fertilizer rates and respectively plant early and mid-way between early and late in the growing season.

Results and Discussion

Under the current climate conditions, the food needs of the large and medium farms were satisfied by on-farm production while the small farm type did not achieve this (Table 1). Under future climate and current cropping practices, food availability was reduced for all farm types, but large farms still achieved food self-sufficiency. The medium farms dropped below the self-sufficiency threshold and small farms experienced a further decrease in food self-sufficiency. Under future climate conditions, large farms increased their food self-sufficiency status by applying recommended fertilizer rates. Medium farms raised food self-sufficiency above 100% by advancing planting from the current medium date (D2) to early planting (D1).

Applying the recommended fertilizer rates in combination with early planting further increased food production, whereas applying recommended fertilizer rates without earlier planting was insufficient to reach food self-sufficiency. For small farms, planting earlier and/or applying the recommended fertilizer rates did not suffice to achieve food self-sufficiency under future climate conditions.

Table 1: Future climate change impact on the food self-sufficiency (% kcal) of large, medium and small farm

	Cropping practice		Climate	Food selfsufficiency	
Large farm	Current practice		Baseline	176	
			rcp4.5	152	
			rcp8.5	146	
	Adaptation option	Fertilizer	rcp4.5	206	
rcp8.5			204		
Medium farm	Current practice		Baseline	103	
			rcp4.5	87	
			rcp8.5	85	
	Adaptation option	F2*D1	rcp4.5	D1	141
				D1	126
				F2	94
		F2*D1	rcp8.5	D1	139
				D1	124
				F2	93
	Small farm	Current practice		Baseline	41
rcp4.5				40	
rcp8.5				39	
Adaptation option		F2*D2	rcp4.5	D2	46
				D2	40
				F2	40
		F2*D2	rcp8.5	D2	45
				D2	37
				F2	39

Conclusions

To achieve family food self-sufficiency in southern Mali current cropping management strategies need to be improved. Early planting is an important option to achieve food self-sufficiency for the medium farms, but was not considered feasible for the small farm.

Acknowledgements

We thank the Mcknight Projects 12-121/12- 634 for funding. Additional funding from Malian government is gratefully acknowledged.

References

- Lobell, D.B. and Burke, M.B. (2008). Why are agricultural impacts of climate change so uncertain? The importance of temperature relative to precipitation. *Environment Research Letters*, 3: 8.
- Traore, B. et al., (2014). Evaluation of climate adaptation options for Sudano-Sahelian cropping systems. *Field Crops Research*, 156: 63-75.

Simulation of ecosystem services of nitrogen management produced by bispecific mixtures of cover crops using the stics soil-crop model

H. Tribouillois^{} – J. Constantin – E. Justes*

INRA, UMR AGIR 1248, F-31326 Castanet-Tolosan, France, *helene.tribouillois@toulouse.inra.fr

Introduction

Cover crops are sown during autumnal fallow period (between two main cash crops) in order to produce ecosystem services as those to manage and recycle nitrogen (N). One of these services is to mitigate N leaching and thus avoid nitrate water pollution by capturing mineral N from soil (SMN). Cover crops can simultaneously produce a “green manure” service which restitutes N for the next cash crop after cover crop residues incorporation (Thorup-Kristensen et al., 2003; Tribouillois et al., submitted). The purpose of this study was to evaluate, thanks to modelling, the abilities of multiple bispecific mixtures to provide simultaneously these services compared to sole crops and bare soil. We hypothesized that some bispecific legume and non-legume mixtures could effectively produce both ecosystem services due to non-legume species ability to capture N and legume ability to improve N acquisition thanks to N₂ fixation.

Materials and Methods

In order to achieve this purpose, we used the soil-crop model STICS to estimate services of i) N leaching mitigation and ii) “green manuring” of cover crop mixtures (CCM). We chose to use modelling because these variables are difficult to obtain by experimental fields due to the various dynamical processes occurring simultaneously. STICS model is a dynamic model that simulates C, N and water cycles with a daily time step according to soil and climate characteristics (e.g. Brisson et al., 2003). It has been satisfactory evaluating to predict N leaching and N mineralization from cover crop residues (Constantin et al., 2012; Justes et al., 2009). The simulations were carried out to evaluate i) 5 legume and 5 non-legume sole crops, ii) 25 bispecific CCM and iii) a control bare soil. The simulations began at the date of cover crop destruction (November) until the 31 May for which N leaching is finished and for obtaining the N mineralization from cover crop residues after an early incorporation; this date also corresponds to the start of N requirements for the next spring cash crop. In order to initiate the model, we carried out 3 experimental fields in 2012 for studying the different treatments at 3 contrasted pedoclimatic sites in France. Sowing occurred in August and destruction occurred in November. SMN and soil water content were measured at sowing and at destruction. Shoot biomass and C:N ratio of CCM were also measured at the destruction.

Results and Discussion

The simulations revealed that CCM composed of legume and non-legume significantly and efficiently reduced N leaching after autumnal destruction in comparison to bare

soil (Figure 1a). Although their performances varied according to intercropped species and pedoclimatic sites, overall, some CCM reduced N leaching as almost efficiently as non-legume sole crops (used as reference for this service). Legume sole crops were less efficient to reduce N leaching but their effect was still significant in comparison to bare soil which confirms that it is better to sow a legume cover than staying a bare soil, concerning nitrate pollution. The predicted amount of N mineralized from CCM residues incorporated in autumn revealed to be intermediate between legume sole crops and non-legume sole crops (e.g. Figure 1b). These simulation results are consistent with literature although they were obtained in other pedoclimatic conditions (e.g. Tosti et al., 2012).

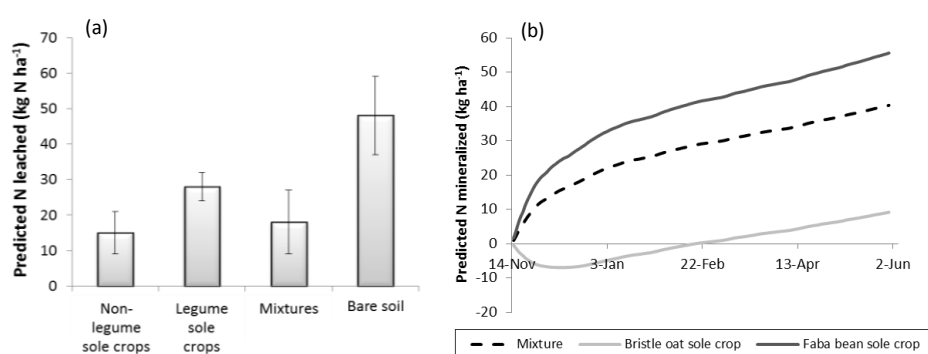

Figure 1. Examples of prediction of N leaching at one site (a) and prediction of N mineralized for one mixture (b) after cover crop destruction and incorporation.

The simulations also revealed that no CCM reached the maximal level (100%) produced by the best sole crops for each service. However, some CCM showed very good abilities of both reducing leaching and “green manuring”, which reached at least 80% of sole crops for each service, such as Italian ryegrass/purple vetch or phacelia/faba bean. These results confirm the interest of these CCM to simultaneously produce both ecosystem services of N management. The simulations also pointed out that according to species, the various CCM produced a gradual range of the 2 services, as compromise between the two ecosystem services, which will help adapting CCM species choice according to fallow period situation (amount of residual SMN, leaching risk due to the types of soils and climates).

References

- Constantin, J., N. Beaudoin, M. Launay et al., (2012). *Agriculture Ecosystems & Environment*, 147: 36–46.
- Brisson, N., C. Gary, E. Justes et al., (2003). *European Journal of Agronomy*, 18 : 309-332.
- Justes, E., B. Mary, B. Nicolardot (2009). *Plant & Soil*, 325: 171–185.
- Thorup-Kristensen, K., J. Magid., L.S. Jensen (2003). *Advances in Agronomy*, 79: 227–302.
- Tosti, G., P. Benincasa, M. Farneselli et al., (2012). *European Journal of Agronomy*, 54: 34–39.
- Tribouillois, H., J.P. Cohan, E. Justes (submitted). *Plant & Soil*.

Evaluation of cascading uncertainty in climate and crop models in assessing the impact of climate change on rice

**G. Vellingiri¹ – R. Palanisamy¹ – B. Kulanthaivelu¹ – G. Ramasamy¹ – L. Arunachalam¹ – S. McDermid² – M. Narayanasamy¹.*

¹ Tamil Nadu Agricultural University, India; email: geetha@tnau.ac.in

²New York University, USA; *corresponding author;

Introduction

The climate system is comprised of numerous complex processes and interactions, that no model can ever be expected to perfectly simulate. While many processes are represented in models by fundamental physics equations, parameterizations are also employed to approximate certain processes. The scientific knowledge on which such parameterizations comes from studying the current climate and proxy studies of past climate and, as such, their ability to simulate the climate under different forcing conditions may potentially be limited. Further the impact models cascade the uncertainty to next level. TO address these issues, a study was carried out at Agro Climate Research Centre, Tamil Nadu Agricultural University, Coimbatore during 2012-2014 to analyze the cascade of uncertainty in climate model projections and crop model simulations for rice crop yields over Thanjavur region of Tamil Nadu, for the 21st century.

Materials and methods

To study the impact of projected climate on rice yield, outputs from 5 climate models viz., CCSM4, GFDL-ESM2M, HadGEM2-ES, MIROC5 and MPI-ESM-MR were utilized in crop model simulation for near (2011-2039), mid (2040-2069) and end century (2070-2099) time slices through DSSAT and APSIM. Climate projections were created by utilizing a “delta” approach, in which the mean monthly changes (from baseline) under RCP 4.5, RCP 8.5 for Near, Mid and End Century time slices that is centered around 2030, 2055 and 2080 respectively were applied to the daily baseline weather series as described by Villegas and Jarvis, 2010. The daily output of the models was converted to decadal, seasonal viz., southwest Monsoon (June, July, August, September) and Northeast Monsoon (October, November, December). The deviations from base year (1980-2010) were calculated by obtaining the difference between the Near, Mid and End century with the base years. The deviations were calculated using all the models and then the maximum, minimum and average was computed. These ranges of maximum, minimum and average are given as uncertainty in climate projections.

Result and Discussion

Irrespective of the models, scenarios and time slices, the maximum and minimum temperatures are projected to increase with seasonal variations. With certainty, the projected increase in maximum and minimum temperature for Thanjavur is 0.3 to 4.6^oC and 0.2 to 5.2^oC. On comparing the monsoons, SWM is projected to have a

higher increase in both maximum and minimum temperature than in NEM. Rainfall is projected to vary between -15.3 to + 80.7 per cent for Thanjavur during 21st century and the increase is expected mainly during NEM season.

DSSAT predicted reduction in rice yield in Thanjavur for all the timescales. The reduction ranged between 13.1 to 18.7, 15.6 to 26.4 and 16.7 to 33.9 per cent for near, mid and end century under RCP 4.5. In case of RCP 8.5 also, DSSAT predicted reduction in yield for all the timescales and the reduction ranged between 14.2 to 17.9, 6.6 to 17.1 and 8.6 to 39.2 per cent for near, mid and end century respectively. APSIM predicted reduction in yield ranged between 3.4 to 8.0, 9.4 to 18.2 and 11.9 to 22.4 per cent for near, mid and end century under RCP 4.5. Reduction in yield ranged between 7.1 to 9.8, 13.5 to 23.0 and 20.5 to 27.6 per cent for near, mid and end century under RCP 8.5. Similar negative response to the increased temperature was reported by Baker and Allen (1993) and Agarwal and Mall (2002).

Altered sowing window showed a positive response in yield with increase ranging from 1.8 to 55.6 per cent. This might be due to the suitable climate conditions that prevailed during the growing season after altering the sowing window. Fertilizer adaptation also had a positive response with increase in yield ranging from 2.0 to 15.5 per cent, similar increment in rice yield to increased N fertilizer application was observed in the study conducted by Kawasaki and Herath (2011) for Khon Kaen province in Thailand.

Conclusion

From the study, it could be concluded that the mean change scenarios obtained through delta approach can successfully be employed in integrated assessments. Multi-model assessment can bring certainty to these projections by giving a range of expected conditions. Among the climatic parameters, maximum and minimum temperatures are projected to continuously increase over time. Rainfall is also projected to increase, but with different magnitude in the Northeast and southwest monsoon seasons. The yield rice is impacted by future climate under current cultivation practices. Crop specific adaptation practices can be successfully employed to minimize the impacts of climate change.

Acknowledgement

We wish to deliver special thanks to Agricultural Model Intercomparison and Improvement Project (AgMIP) team for funding the research.

Reference

- Villegas, J.R and A. Jarvis. (2010). Downscaling Global Circulation Model Outputs: The Delta Method Decision and Policy Analysis Working Paper No. 1. International centre for tropical agriculture.
- Baker, J.T and L.H. Allen, Jr. (1993). Contrasting crop species responses to CO₂ and temperature: Rice, soybean, and citrus. *Vegetatio.*, 104/105: 239-260.
- Agarwal, P.K and R.K. Mall. (2002). Climate change and rice yields in diverse agro-environments of India. II. Effect of uncertainties in scenarios and crop models on impact assessment. *Clim. Chan.* 52(3): 331-343.
- Kawasaki, J and S. Herath. (2011). Impact assessment of climate change on rice production in India. *J. ISSAAS.*, 17(2):14-28.

Climate cafe: first results of the cropping systems simulations with the model STICS

A. Vermue^{*} – *D. Plaza-Bonilla* – *E. Justes*

UMR 1248 AGIR, INRA, Toulouse, France, *e-mail: anthony.vermue@toulouse.inra.fr

Introduction

While agriculture directly contributes to climate change (CC) with greenhouse gas emissions, side effects of the CC also affect agricultural production. In particular, temperature and rainfall alterations may affect soil biogeochemical cycles and indirectly alter crop development. The effects of CC are, however, still not clearly identified and may differ from one region to another (Olesen et al., 2011; Reidsma et al., 2010; Moriondo et al., 2010). It is therefore necessary to investigate these effects on agricultural production, in order to offer adapted and effective solutions for each pedoclimatic context. In response, the project Climate-CAFE gather 9 European countries and aims at assessing and increasing the « adaptive capacity » to CC of arable cropping and farming systems. The modelling approach should provide a first assessment of the CC effects on European agricultural production and allow potential adaptation measures to be identified. Soil-crop models are commonly used in the assessment of cropping systems performance under climate change (Easterling et al., 2007). Among these models, the model STICS (Brisson et al., 2003; 2002; 1998) has been used extensively in the evaluation of innovative cropping systems in Europe (Kollas et al., 2015). In the framework of the project, the model STICS will be used to (1) assess the CC effects on European cropping systems according to a South-North gradient (from Spain to Finland) and (2) assess potential adaptation measures. Here, the first modelling assessment will focus on low-input cropping systems in France, under current climate and future CC.

Materials and Methods

The model STICS was used to simulate 3 low-input experimental cropping systems, located at the French National Institute for Agricultural Research (INRA) in Auzeville, France (43° 31'N, 1° 30'E). These systems were designed in the framework of the Grain Legumes FP6 project, to reduce their input dependencies (irrigation water, N fertilizer and pesticides), while aiming at the production of quality grains (rather than maximizing yields). The main hypothesis was that sustainability of the systems could be increased with a gradient of grain legumes integration in the rotations and the implementation of cover crops (nitrogen-fixing and green manure cover crops). Detailed rotations of the cropping systems are shown in Table 1.

Table 1. Integration of grain legumes in the 3-year rotations of the low-input cropping systems analyzed

Rotation	Crop 1	Cover Crop	Crop 2	Cover Crop	Crop 3	Cover Crop
GL0	sorghum	-	sunflower	vetch	durum wheat	vetch + oat
GL1	sunflower	mustard	winter pea	mustard	durum wheat	vetch + oat
GL2	soybean	-	spring pea	mustard	durum wheat	mustard

Crop management practices were specifically adapted to each cropping system (i.e. N fertilizer, irrigation water applied, tillage events, crop protection, etc.).

The current climate context study focused on two cycles of rotations of the cropping systems, between the year 2005 and 2010. For simulating future climatic conditions, the representative concentration pathways (RCP) 4.5 and 8.5 defined by the IPCC (2013) were used, respectively corresponding to the limited and increased greenhouse gas emissions future scenarios.

Results and Expectation

The model STICS performed reasonably well in the simulation of the cropping systems and soil biogeochemical processes under current climate condition, especially soil water and nitrates contents, crop biomass and N acquired (Plaza-Bonilla et al., 2015a). After two cycles of 3-years rotation, the integration of grain legumes both enhanced carbon and nitrogen leaching. However, the inclusion of cover crops significantly mitigated SOC and SON losses and increased the N use efficiency (Plaza-Bonilla et al., 2015b). Future simulations will allow the long term effects of CC on the cropping systems to be estimated. Both RCP scenarios are expected to impact negatively cropping systems performances without adaptation given the vulnerability to CC of field crops (Olesen et al., 2011; Vadez et al., 2010).

Acknowledgements

This research is supported by the metaprogramme Adaptation of Agriculture and Forests to Climate Change (AAFCC) of the French National Institute for Agricultural Research (INRA). The Climate-CAFE project was funded by the joint programming initiative FACCE ERA-NET Plus and the European Commission (EC contract 618105).

References

- Brisson N., Gary C., Justes E, et al., (2003). *European Journal of Agronomy*, 18: 309–332.
- Brisson N., Mary B., Ripoche D., et al., (1998). *Agronomie*, 18: 311–346.
- Brisson N., Ruget F., Gate P. et al., (2002) *Agronomie*, 22: 69–92.
- Easterling W., Aggarwal P., Batima P. et al (2007). In: Parry M. L. et al., eds, *Climate Change 2007: Impacts, Adaptation and Vulnerability*. Cambridge University Press, Cambridge, UK, pp 273–313.
- IPCC (2013). Cambridge University Press, Cambridge, United Kingdom and New York, NY, USA, 1535 pp.
- Moriondo M., Bindi M., Kundzewicz Z.W. et al., (2010) *Mitigation and Adaptation Strategies for Global Change*, 15: 657–679.
- Olesen J.E., Trnka M., Kersebaum K.C. et al., (2011). *European Journal of Agronomy*, 34: 96–112.
- Plaza-Bonilla D., Nolot J.-M., Raffailac D. et al., (2015a). *Agriculture, Ecosystems and Environment*, 212: 1–12.
- Plaza-Bonilla D., Nolot J.-M., Passot S. et al., (2015b) *Soil and Tillage Research*. In press.
- Reidsma P., Wolf J., Kanellopoulos A. et al., (2015) *Environment Research Letters*, 10: 045004.
- Vadez V., Berger J.D., Warkentin T. et al., (2012) *Agronomy for a Sustainable Development* 32: 31–44.

The effect of using different soil hydraulic parameters on the outputs of a simple crop growth model

*M. Wegehenkel*¹ – *C. Kollas*² – *K. C. Kersebaum*¹ – *C. Nendel*¹

¹ Department, Institute of Landscape Systems Analysis, ZALF, D-15374 Müncheberg, Eberswalder Strasse 84, e-mail: mwegehenkel@zalf.de

² Potsdam Institute for Climate Impact Research (PIK), D-14473 Potsdam, Telegraphenberg A31

Introduction

The impact of climate change on crop productivity and soil water balance have been studied with crop growth models using inputs obtained from different climate change scenarios in projects such as the Agricultural Model Intercomparison and Improvement Project (<http://www.agmip.org>) or the MACSUR-Project (<http://www.macsur.eu>). For the validation of such models, field experimental data are needed. The precision of the calculation of soil water balance depends on the description of soil hydraulic properties. For the application of tipping bucket models, these properties are described by field capacity and wilting point. For models based on the Richards-equation, the functions soil water content versus pressure head $\theta(h)$ and hydraulic conductivity versus pressure head $k(h)$ are required to describe soil hydraulic properties by using e.g. the van Genuchten-Mualem (vGM)-equations (van Genuchten, 1980; Mualem, 1976). In our study, we analyzed the impact of the application of different soil hydraulic data sets on the outputs of a crop growth model.

Materials and Methods

In a study of Kollas et al., (2015), the capability of fifteen crop growth models to predict yields in crop rotations was analyzed using data sets from five test sites across Europe. In our study, we re-used these experimental field data, which comprised only basic soil information such as texture, bulk density, field capacity and wilting point (Kollas et al., 2015). These data were used for the generation of different soil hydraulic parameter sets by using pedotransfer functions. These parameter sets consist of the parameters of the vGM-equations (θ_s , θ_r , α , n) and values for saturated hydraulic conductivity K_{sat} and were used as input for the application of the model THESEUS (Wegehenkel, 2005), which consists of the crop growth model Wofost7.1 (van Ittersum et al., 2003) and a soil water flux model using the Richards-equation.

Results and Discussion

In the presented example for the test site Braunschweig located in Northern Germany, the higher saturated hydraulic conductivity of the second set of soil hydraulic parameters (Table 1) led to higher drainage, corresponding lower transpiration and available soil water storage leading to lower LAI and above ground biomass especially in the years 2001 and 2004 with the crop sugar beet (Figure 1).

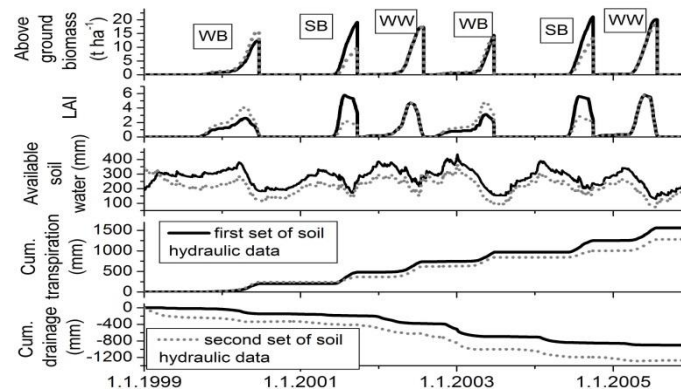

Figure 1. Model results consisting of a crop rotation (6 years): winter barley (WB), sugar beet (SB) and winter wheat (WW) at the test site Braunschweig

Table 1. Soil hydraulic parameters at the test site Braunschweig

θ_s ($\text{cm}^3 \text{cm}^{-3}$)	θ_r ($\text{cm}^3 \text{cm}^{-3}$)	α (cm^{-1})	n	K_{sat} (cm d^{-1})
First set of soil hydraulic properties / second set of soil hydraulic properties				
0.49/0.46	0.14/0.07	0.029/0.005	1.39/1.65	2/25
0.49/0.45	0.16/0.07	0.030/0.005	1.52/1.70	2/31
0.49/0.45	0.19/0.07	0.030/0.005	1.56/1.65	2/21

Conclusions

Our results indicate the need for a proper estimation of soil hydraulic parameters and for the definition of confidence intervals of these parameters for impact studies.

Acknowledgements

The work of the model intercomparison was founded by the MACSUR-project. In addition we have to thank the experimental field data providers for the model intercomparison.

References

- Kollas, C., Kersebaum, K.-C., Nendel, C., Manevski, K., Müller, C., Palosuo, T., Armas-Herrera, C. M., Beaudoin, N., Bindi, M., Charfeddine, M., Conradt, T., Constantin, J., Eitzinger, J., Ewert, F., Ferrise, R., Gaiser, T., de Cortazar-Atauri, I. G., Giglio, L., Hlavinka, P., Hoffmann, H., Hoffmann, M. P., Launay, M., Manderscheid, R., Mary, B., Mirschel, W., Moriondo, M., Olesen, J. E., Öztürk, I., Pacholski, A., Ripoche-Wachter, D., Roggero, P. P., Roncossek, S., Rötter, R. P., Ruget, F., Sharif, B., Trnka, M., Ventrella, D., Waha, K., Wegehenkel, M., Weigel, H.-J., Wu, L. (2015) Crop rotation modelling - a European model intercomparison. *European Journal of Agronomy* 70: 98-111.
- Mualem, Y. (1976). A new model for predicting the hydraulic conductivity of unsaturated porous media. *Water Resources Research* 12(3): 513-522.
- Van Genuchten, M. (1980). A closed form equation for predicting the hydraulic conductivity of unsaturated soils. *Soil Science Society of America Journal* 44: 892-898
- van Ittersum, M.K., Leffelaar, P.A., van Keulen, H., Kropff, M.J., Bastiaans, L., Goudriaan, J. (2003). On approaches and applications of the Wageningen crop models. *European Journal of Agronomy* 18: 201-234.
- Wegehenkel, M. (2005). Validation of a soil water balance model using soil water content and pressure head data. *Hydrological Processes* 19: 1139-1164.

Describing dry matter and N distribution of winter oilseed rape by organ specific approaches to improve simulated crop response to N deficiency

W. Weymann – U. Böttcher – K. Sieling – H. Kage

Institute of Crop Science and Plant Breeding, Faculty of Agricultural and Nutritional Sciences, Christian-Albrechts-University at Kiel, Hermann-Rodewald-Str. 9, 24118 Kiel, weymann@pflanzenbau.uni-kiel.de

Introduction

Winter oilseed rape (WOSR) is a major crop in cropping systems in central to northern Europe. It is characterized by high nitrogen (N) demand but low N use efficiency and low N harvest index compared to cereals (Schjoerring et al., 1995; Hocking et al., 1997; Dreccer et al., 2000). National and European directives limit N fertilization and N balance. Therefore, optimization of N management and understanding of crop response to N deficiency are major goals of recent scientific research. Simulation modeling thereby seems to be an inevitable tool.

To simulate crop growth of WOSR under optimal and N limited conditions, physiological processes as dry matter partitioning and N distribution under varying N treatments have to be described with sufficient accuracy.

Materials and Methods

Data for analysis were taken from two field trials at Hohenschulen (NW-Germany). Experiment 1 was carried out between 2003/04 and 2005/06 with varying spring N treatments (0, 80, 160, 240 kg N ha⁻¹). Experiment 2 (2009/10, 2010/11 and 2012/13) tested 80 management treatments, including 4 sowing dates, 4 autumn N application levels (0, 30, 60, 90 kg N ha⁻¹) and 5 N treatments in spring (0, 80, 160, 240, 280 kg N ha⁻¹).

Effects of N application on dry matter partitioning and N dynamics were investigated by statistical analyses.

Results and Discussion

Dry matter partitioning between leaves, stems and pods can be described by allometric relations. Allometric approaches rely on a constant ratio of relative growth rates, resulting in a linear relationship between the natural logarithms of dry matter fractions.

From emergence until stem elongation and between stem elongation and onset of flowering, stem and leaf dry matter correlated significantly. Allometric relation varied with growth due to increasing sink size of stems for assimilates after beginning of stem elongation (Gabrielle et al., 1998). From beginning of inflorescence emergence until end of flowering, stem and pod dry matter were significantly correlated. N fertilization did not affect the allometric relations of dry matter fractions (data not shown).

N distribution within the plant based on the relationship between N uptake and dry matter accumulation, described by N dilution curves. N dilution curves for total above-ground biomass of WOSR were already published by Colnenne et al., (1998) but our data showed that N dilution curves differed between plant organs and in their response to N deficiency. N dilution in leaves followed a linear function before stem elongation, and leaf N concentration was constant afterwards. In contrast, N dilution in stems, pods and roots followed logarithmic functions (Figure 1), varying between plant organs and growth stages.

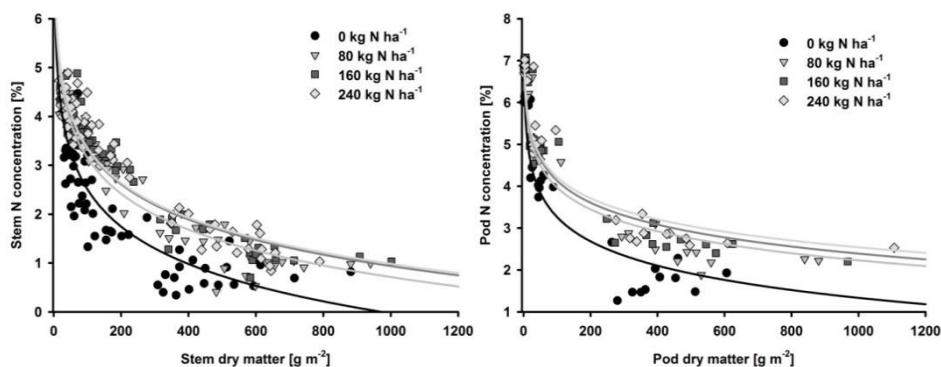

Figure 1. N dilution curve of stems and pods during spring growth under consideration of N application level

A comparison of dry matter productivity response to N deficiency simulated either with a common N-shoot dilution curve or organ specific dilution curves indicated a better description of experimental data.

Conclusions

Allometric approaches and N dilution curves are useful to describe dry matter partitioning and N distribution in WOSR. Organ specific investigations improve the simulation of crop growth under optimal and N limited conditions.

References

- Colnenne, C., Meynard, J.M., Reau, R., Justes, E., Merrien, A. (1998). Determination of a Critical Nitrogen Dilution Curve for Winter Oilseed Rape. *Annals of Botany* 81, 311–317.
- Dreccer, M.F., Schapendonk, A.H.C.M., Slafer, G.A., Rabbinge, R. (2000). Comparative response of wheat and oilseed rape to nitrogen supply: absorption and utilisation efficiency of radiation and nitrogen during the reproductive stages determining yield. *Plant and Soil* 220, 189–205.
- Gabrielle, B., Denoroy, P., Gosse, G., Justes, E., Andersen, M.N. (1998). Development and evaluation of a CERES-type model for winter oilseed rape. *Field Crops Research* 57, 95–111.
- Hocking, P.J., Randall, P.J., DeMarco, D. (1997). The response of dryland canola to nitrogen fertilizer: partitioning and mobilization of dry matter and nitrogen, and nitrogen effects on yield components. *Field Crops Research* 54, 201–220.
- Schjoerring, J.K., Bock, J.G.H., Gammelvind, L.H., Jensen, C.R., Mogensen, V.O. (1995). Nitrogen incorporation and remobilization in different shoot components of field-grown winter oilseed rape (*Brassica napus L.*) as affected by rate of nitrogen application and irrigation. *Plant and Soil* 177, 255–264.

Simulation of real-time nitrogen leaching for better crop nitrogen fertilizer management

H. Yang – P. Grassini – K. Cassman

Department of Agronomy and Horticulture, University of Nebraska – Lincoln, PO BOX 830915, Lincoln, NE 68583-0915, USA, email: hyang2@unl.edu

Introduction

Robust, real-time estimation of nitrogen (N) leaching below the root zone can help improve N fertilizer management in a crop field and inform agricultural policies. Two factors that ultimately drive N leaching at a point in time are: (1) amount of water drainage below the root zone, and (2) amount of inorganic N in soil which, in turn, is determined by N supply primarily from N mineralization of soil organic matter (SOM), N fertilizer application, and N crop N uptake. The objective of this study is to describe the process of simulating N leaching in a maize field using the Maize-N model (<http://hybridmaize.unl.edu/maizen.shtml>).

Simulation approach

Robust simulation of N leaching requires accurate estimation of crop N removal and the N supply from all sources. This requires the following: (1) soil texture, SOM content, and maximum soil rooting depth, (2) previous season's crop yield and amount of N fertilizer applied, (3) current season's crop cultivar, sowing time, and plant population, (4) amount of N fertilizer and manure that has been applied to date, and (5) real-time and historical weather data. Simulations of N and carbon mineralization and water balance start from the end of last crop until maturity of the current crop on a daily time step.

The entire rooting depth is treated as one zone for simulation of water and N balance. Drainage below maximum rooting depth occurs when soil water is greater than the maximum soil water holding capacity. Daily N leaching ($N_{leaching}$) is calculated as $Drain * [N]$, in which *Drain* is drainage amount and [N] the nitrate concentration in soil water. The key to soil water balance is the water loss through soil evaporation before emergence or crop evapotranspiration (ET) after emergence. Soil evaporation is simulated using FAO's 2-stage method (Allen et al., 1998), while crop ET after emergence is simulated using crop leaf area index and reference ET that are generated from built-in Hybrid-Maize model routines (Yang et al, 2004).

For N balance in soil, major inputs include inorganic N remaining from the previous crop, mineralization of SOM, crop residues and manures (if applied), and fertilizer. Major N removal includes crop N uptake and N leaching. Mineralization of N (along with carbon) is simulated using Yang and Janssen's dynamic one-pool approach (2000). Crop N uptake is simulated using the N uptake dynamic function by Plenet and Lemaire (1999): $N_{uptake} = 34 * W^{0.63}$, in which N_{uptake} is in $kg\ ha^{-1}$ and W the crop biomass in $Mg\ ha^{-1}$. The exponent value in this equation, however, is derived from the total N

requirement for a crop yield from the Maize-N model (Setitono et al., 2011), while crop biomass of a given day is simulated from Hybrid-Maize routines.

Results and Discussion

The model simulates a reasonable temporal pattern of N mineralization from SOM, total nitrate in soil, and N leaching for a maize field that was sowed in early May with N application of 50 kg N ha⁻¹ in late April (Fig 1, left). Simulated total soil nitrate increased slowly due to cool temperatures in spring with an abrupt increase in late April due to N fertilizer application. The wet soil at sowing and a heavy rainfall event (about 100 mm) in early May led to significant N leaching. For the estimation for N fertilizer rate at the time of simulation (Fig. 1, right), the simulated total N leaching up to today is compared against the average N leaching during the same period using historical weather data; the excessive N leaching is compensated in the N fertilizer rate recommendation, because model parameters for N recovery efficiencies are based on experimental data which should reflect average N leaching losses.

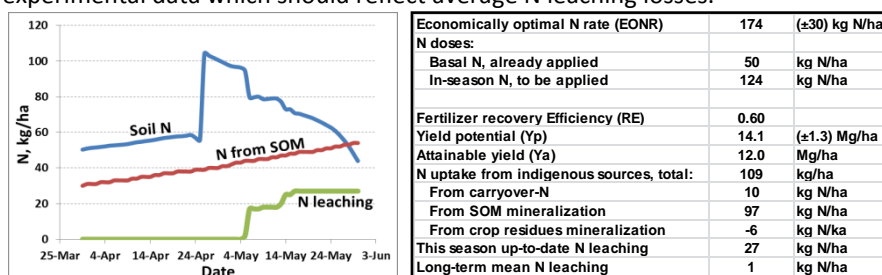

Figure 1. Simulated cumulative soil mineral N, N from SOM and N leaching from April 1 to May 31 with a heavy rain in early May of the current season (left) and fertilizer N requirement (right) and N balance from Maize-N model for a maize field that received a basal N of 50 kg ha⁻¹ in late April.

Combining the Plenet and Lemaire N uptake dynamics function with the total crop N requirement estimation from the original Maize-N model provides a novel approach that is suitable for estimating daily crop N demand for more diverse cropping systems and environmental conditions. We are currently testing the Maize-N model with the added N leaching routine. Areas for improvement in modeling N leaching include (1) dividing the soil rooting depth into functional layers that have different soil texture, water holding capacities, and nitrate-N concentrations, and (2) routines for estimating denitrification losses under saturated soil conditions.

Reference

- Allen, R.G., L.S. Pereira, D. Raes et al (1998). FAO Irrigation and Drainage Paper No. 56.
 Plenet, D. and G. Lemaire (1999). Plant and Soil. 216: 65-82.
 Setiyono, T.D., H.S. Yang, D.T. Walters et al (2011). Agronomy Journal. 103:1-8.
 Yang, H.S., A. Dobermann, J.L. Lindquist et al (2004). Field Crops Research. 87:131-154.
 Yang, H.S. and B.H. Janssen (2000). European Journal of Soil Science. 51:517-529.

Evaluating the potential of rice production in Taiwan by using DSSAT and the statistical downscaling model to generate future climate data

M.-H. Yao^{1} – Y.-S. Jhong¹ – Y.-H. Hsu²*

¹ Researcher and Assistant, Agricultural Engineering Division, Taiwan Agricultural Research Institute, Taichung, Taiwan, ROC

² Assistant Research Fellows, National Science and Technology Center for Disaster Reduction, Taipei, Taiwan, ROC

*Corresponding author, Email : MHYao@tari.gov.tw

Introduction

Taiwan's main crop is rice, and any change in rice yield is critical for food security. In the face of future climate change, accurately estimating the yield of rice and performing related adjustments is crucial. However, interaction between the meteorological environment during farming and crop growth is complex. Assessing crop yield and climate factors typically relies on crop modeling, and the DSSAT software is widely used in rice-producing countries for assessing the impact of climate change (Basak, 2010). By analyzing future climate conditions predicted using RCP4.5 and RCP8.5 from IPCC AR5, this study generated data applicable to Taiwan by utilizing the statistical downscaling model. The confirmed climate data were then entered into a food production assessment system to perform a DSSAT simulation. Through the setting of various climate scenarios, the change in rice yield for Taiwan was estimated for various times and locations. This information can be used for formulating an adaption strategy for rice cropping systems in response to climate change.

Materials and Methods

In this study, a food production assessment system was developed, with DSSAT used to integrate a database containing rice growth parameters relevant to Taiwan. Through parameter selection, sensitivity analysis, as well as the simulation and validation of production yield, a consistent computation process was established. The simulation results were then input into a geographic information and systematic function to divide Taiwan into 1568 grid points according to the estimates of 5 × 5-km grids, and the differences in rice production yield among various grid locations were assessed. Generating future climate data involved adopting bias correction and spatial disaggregation to downscale the global climate data from the IPCC AR5 to a 5 × 5-km resolution. In addition to the downscaling of spatial data, the DSSAT model requires climate data at the “day” scale. Therefore, random weather generators (WGs) were employed to produce day-scale data (Richardson, 1981). Currently, many scholars use WGs in impact assessment studies on climate change (Semenov and Barrow, 1997; Kilsby et al., 2007).

Results and Discussion

Taiwan's rice harvest is divided into two crops. The first crop is in February to June, during which time the average temperature is lower, the number of days to growth is

120, and the yield is higher compared with the second crop (August–November), in which the number of days to growth is 100. The results from the downscaling of the AR5 data indicate that future temperatures in Taiwan will rise, which will reduce the number of days for growing rice. The zone where the number of growth days is fewer than 120 extends from Southern Taiwan to Central Taiwan. Under the scenarios of RCP4.5 and RCP8.5, the yield also shows a decreasing trend toward the end of the century (long term), an average reduction in rice yield by 7% and 13% (Fig. 1), and yield reductions of approximately 555 and 1100 kg ha⁻¹ for RCP4.5 and RCP8.5, respectively. An effective adjustment strategy could assist in adjusting the seeding date according to the future climate conditions (e.g., planting first crop earlier and second crop later) to avoid the high-temperature period. Advancing the planting date for first crop by 30 days could increase the yield by 438 kg ha⁻¹, whereas delaying the planting date of second crop by 10 days could increase the yield slightly, though a reduction was forecast for delays of 20 and 30 days.

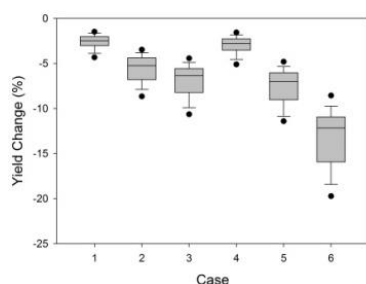

Figure 1. Boxplot showing short-term (2016–2035), mid-term (2046–2065), and long-term (2081–2100) changes in rice yield relative to the baseline (1986–2005) under the RCP4.5 (Cases 1–3) and RCP8.5 (Cases 4–6) scenarios.

Conclusions

This study used a crop model to establish an assessment tool for crop yield under climate change and conducted a grid point analysis based on geographic information system data to predict the difference in rice yield under various climate change scenarios. For Taiwan, rice yield was predicted to exhibit a decreasing trend, with the RCP4.5 and RCP8.5 conditions revealing total yield reductions of 986 and 1903 kg ha⁻¹ for two crops, respectively. After adjustment of the rice-planting periods, in which the planting of first crop was advanced by 30 days and that of second crop was delayed by 10 days, the entire farming field over the entire year could increase the rice yield by 448 kg ha⁻¹ compared with current yields, thus mitigating the anticipated decrease in rice yield.

References

- Basak, J. K., M. A. Ali, M. N. Islam and M. A. Rashid. (2010). *J. Civil Engineering* 38: 95-108
- Kilsby, C. G., P. D. Jones, A. Burton, A. C. Ford, et al., (2007). *Modeling Software* 22: 1705-1719.
- Richardson, C.W. (1981). *Water Resources Research*, 17:182-190.
- Semenov, M.A. and E.M. Barrow. (1997). *Climate Change*. 35: 397-414.

Improving phenology predictions with multi-model ensemble

*K. Yun*¹ – *J. Hsiao*² – *M. Jung*³ – *I. Choi*⁴ – *S.-H. Kim*^{5*}

¹ School of Environmental and Forest Sciences, University of Washington, kdyun@uw.edu

² Department of Biology, University of Washington, ach315@uw.edu

³ Department of Agricultural Environment, National Academy of Agricultural Science, weph0486@rda.go.kr

⁴ Department of Agricultural Environment, National Academy of Agricultural Science, finder@rda.go.kr

⁵ School of Environmental and Forest Sciences, University of Washington, soohkim@uw.edu

Introduction

Phenology prediction is often modeled by different types of thermal time response. Growing degree is defined by heat accumulation unit above a certain base temperature. Chilling and forcing model assumes two distinct stages of chill and heat accumulation of thermal units (Cesaraccio et al., 2004). Beta function-based model (BETA) uses a non-linear thermal unit (Yan and Hunt, 1999). Days transferred to standard temperature normalizes growth rate based on the Arrhenius law (Ono and Konno, 1999). It is critical but can be difficult to select a model with the most prediction power for various types of species or cultivars and environmental condition being simulated. In this research, we show that a multi-model ensemble can provide stable predictions of phenology.

Materials and Methods

Four phenology prediction models were used for comparison and ensemble: growing degree (GD), chilling and forcing (CF), beta function-based (BETA), and days transferred to standard temperature (DTS). Observations for full bloom date of four deciduous fruit and ornamental tree species from multiple locations in United States and South Korea were used in this study. Corresponding hourly temperature records were collected from the closest weather stations. The number of datasets used for evaluation was 137 in total; two cherry cultivars in Washington D.C., 15 locations for Korean cherry, 22 apple cultivars from Kearneysville, WV, and 50 locations for a Korean peach and pear cultivars, respectively. The models were 5-fold cross-validated by randomly constructing five sub-datasets where one was saved for validation and the other four was used for calibration. Seven metrics were used for model evaluation, including Willmott's index of agreement and Nash-Sutcliffe efficiency (Willmott et al., 2012). A metric calculated for each combination was ranked by its magnitude. The averaged ranks were then used by a non-parametric Friedman test to detect significant difference in performance between the models. Once found significance, Nemenyi post-hoc analysis was applied to perform pair-wise comparisons among the models. Initially, only individual models were tested to find outperforming models, and then, an ensemble model was added to the pool to see any change. The ensemble model was constructed by averaging out the output of participating models with an equal weight.

Results and Discussion

Individual model performance was variable depending on the dataset and metrics. DTS appeared to show well-balanced performance in many of the cases. CF showed its strength on Korean datasets under four metrics, while GD performed well for Kearneysville apple under three metrics. There was no incidence that BETA outperformed others. The Friedman test showed that some of these difference could be significant in all metrics ($p < 0.01$). The Nemenyi post-hoc analysis revealed DTS performance was significantly higher than BETA and CF for at least one metric, but there was no significant difference between DTS and GD. Also there was no significance reported at all by five metrics.

When compared with individual models, EN consistently showed better performance than any others in all datasets, except for DC cherry under four metrics, where it was ranked second only to DTS. The Friedman test showed even much stronger evidence that the average ranks between the models were not the same ($p < 0.001$). The Nemenyi post-hoc analysis revealed that EN exhibited significantly improved performance compared to GD and BETA in all seven metrics, better than CF in three metrics, and better than DTS in two metrics. There was little difference between individual models. Difference between DTS and BETA was supported by three metrics, CF-BETA was by two, and GD-CF and GD-DTS was only supported by one metric. Other comparisons were all non-significant that once again indicated no clear winner among individual models.

Conclusions

We showed that the performance of individual models for phenology prediction was dependent on the dataset and there was no single model that outperformed other models we tested. A simple ensemble model composed of the same individual models with equal weights showed significantly improved performance than the individual models in the most cases we tested.

Acknowledgements

This study was carried out with the support of "Cooperative Research Program for Agricultural Science & Technology Development (Project No. PJ01000707)", Rural Development Administration, Republic of Korea. We thank Dr. Michael Glenn for providing apple bloom data from Kearneysville, WV.

References

- Cesaraccio, C., D. Spano, R. Snyder et al., (2004). *Agricultural and Forest Meteorology*, 126: 1–13.
- Yan, W. and L. Hunt (1999). *Annals of Botany*, 84: 607–614.
- Ono, S. and T. Konno. (1999). *Japan Agricultural Research Quarterly*, 33: 105–108.
- Willmott, C., S. Robeson, K. Matsuura (2012). *International Journal of Climatology*, 32: 2088–2094.

Assessment of DSSAT and WOFOST sensitivity to temperature derived from AgMERRA

H. Zare^{*} – *M. H. Fallah* – *S. Asadi* – *A. Mojab* – *M. Bannayan*

Agronomy Department, Institute, Faculty of Agriculture, Ferdowsi University of Mashhad, Azadi square, Mashhad, Iran, *e-mail: h_zare@stu.um.ac.ir

Introduction

Crop growth simulation models are useful tools to describe growth and yield at field scale, requiring location-specific, spatially homogenous input data (Tao et al., 2009). As weather stations are so sparse across the world, geospatial interpolation methods contain error and uncertainty. Gridded weather data such as AgMERRA, have been used as alternatives in regions where observed weather data are not available. Considering different crop growth models uncertainty and sensitivity to Gridded weather data are a controversial issue for model improvement in recent years. The present study aims to compare DSSAT and WOFOST sensitivities to precipitation and temperature derived from AgMERRA dataset.

Materials and Methods

In this paper two dynamic, mechanism models World Food Study (WOFOST) and Decision Support System for Agrotechnology Transfer (DSSAT) was applied. The models was calibrated based on measured data from field experiments on irrigated wheat (Falat cultivar) in Khorasan province.

The AgMERRA climate forcing datasets provide daily, high-resolution, continuous, meteorological series over the 1980-2010 period (Ruane et al., 2015). Daily maximum temperature (Tmax) and minimum temperature (Tmin) were obtained from AgMERRA over three locations in Khorasan province (Birjand, Bojnord and Mashhad). Both crop models were run once by temperature derived from meteorological station and then by temperature derived from AgMERRA.

Results and Discussion

Results of comparison of AgMERRA derived temperature and observed data showed a strong agreement. However, R^2 between simulated and observed Tmax was more than Tmin in all locations (Table1). Among the locations, AgMERRA had better performance in Mashhad (Central part of study region).

Both DSSAT and WOFOST had an acceptable performance using AgMERRA data input instead of station data. Both models underestimated the simulated yield potential by AgMERRA data for Birjand (South part). Although AgMERRA data had highest error (RMSE) to simulate temperature in Bojnord (North part), but both models simulated potential yield with higher R^2 . Both DSSAT and WOFOST underestimated when the yield was low, while for higher yield they showed overestimation. It seems that when AgMERRA data was used as input, DSSAT had better performance in Bojnord. On the

other side, when AgMERRA data was used as input, WOFOST had better performance in Birjand and Mashhad.

Table 1. Comparison of simulated Tmax and Tmin by AgMERRA and observed by RMSE and R².

Location	Tmax		Tmin	
	RMSE	R ²	RMSE	R ²
Birjand	3.39	0.965	3.95	0.854
Bojnord	4.93	0.937	5.60	0.877
Mashhad	2.35	0.9609	2.84	0.898

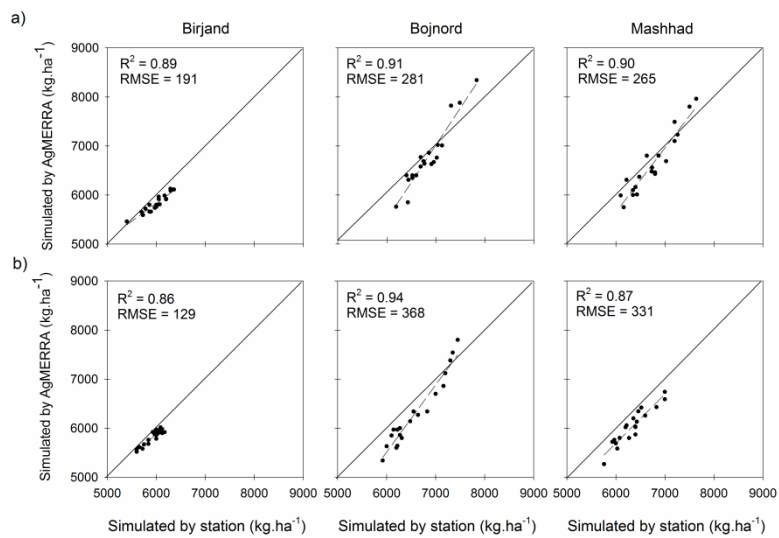

Figure 1. Comparison of simulated (by AgMERRA data) vs. simulated (by station data) yield (a: WOFOST and b: DSSAT). The solid line is 1:1 line and dash line is the regression.

Conclusions

AgMERRA could accurately simulate temperature. Both DSSAT and WOFOST performed very well when AgMERRA temperature was used as input. However, they showed different accuracy among the locations.

References

- Tao, F., M. Yokozawa and Z. Zhang (2009) Modelling the impacts of weather and climate variability on crop productivity over a large area: a new process-based model development, optimization, and uncertainties analysis. *Agricultural and Forest Meteorology* 149: 831–850.
- Ruane, A., R. Goldberg, and J. Chryssanthacopoulos (2015) AgMIP climate forcing datasets for agricultural modeling: Merged products for gap-filling and historical climate series estimation. *Agr. Forest Meteorol.*, 200, 233-248.

Simulation of potato dry matter production under split-N fertigation and sandy soil conditions

Z. Zhou – M. N. Andersen – F. Plauborg

Department of Agroecology, Faculty of Science and Technology, Aarhus University, Foulum, Blichers Alle 20, 8830 Tjele, Denmark

Corresponding author Email: Zhou.zhenjiang@agro.au.dk

Introduction

Daisy is a process based model focusing on agro-ecosystems. It simulates water, heat, carbon, and nitrogen balances as well as crop production subjected to various management strategies (Hansen et al., 2012). The Daisy model has been tested across Europe on potato yield, with relative root mean square error (RMSE) ranging from 1% to 30% (Heidmann et al., 2008).

The current study explored the ability of Daisy to predict the tuber and shoot dry matter during the growing season. Especially considering that potato was grown under split-N fertigation condition in sandy soil.

Materials and Methods

Two experiments with potato (*Solanum tuberosum* L. cv. Folva) were conducted from 2013 to 2014 in Denmark Jyndevad Research Station (54°53'60"N, 9°07'30"E) with field experiment. The soil is characterized as coarse-textured sandy soil. Detailed soil properties can be found in the following references (Hansen, 1976). 8 plants in each plot were sampled to determine tuber and shoot dry matter.

Results and Discussion

To test the ability of Daisy to predict dry matter production of potato under split-N fertigation regime, a validation study was carried out. Here only the results from 2013 are present. Figure 1 shows a comparison of observed and simulated tuber and shoot dry matter of potato. Quite good agreement between tuber dry matter was found. However, shoot dry matter was underestimated due to rather late N fertigation, suggesting shoot dry matter hardly showed any response to late N application. But in reality, shoot dry matter could still response to N application through fertigation, even fertigation was applied late in the season.

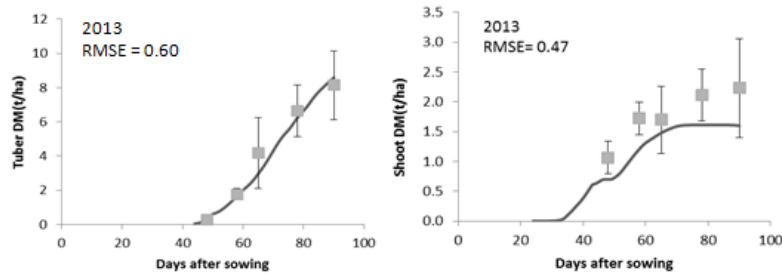

Figure 1. Observed (squares) and simulated (solid line) potato tuber and shoot dry matter development. Potato was adequately irrigated through drip irrigation and 42kgN ha^{-1} was supplied at sowing and the rest was applied as split-N fertigation with 7 doses weekly conducted and each dose contained 20kgN ha^{-1} . Vertical bars indicate standard deviation ($n=4$).

Conclusions

The model can describe tuber dry matter adequately during the whole growing season. Shoot dry matter can also be predicted well if split-N fertigation was applied early in the season.

Acknowledgements

Fund of this study was supported by the EU project (Figaro 925729). Thank is also given to CSC in China for the financial support of Zhenjiang Zhou for his Ph. D research.

References

- Hansen, L. (1976). Jordtyper ved statens forsogsstationer. Tidsskr. Planteavl 80, 742-758.
- Hansen, S., Abrahamsen, P., Petersen, C.T., Styczen, M., (2012). DAISY: MODEL USE, CALIBRATION, AND VALIDATION. Transactions of the Asabe 55, 1315-1333.
- Heidmann, T., Tofteng, C., Abrahamsen, P., Plauborg, F., Hansen, S., Battilani, A., Coutinho, J., Dolezal, F., Mazurczyk, W., Ruiz, J.D.R., Takac, J., Vacek, J., (2008). Calibration procedure for a potato crop growth model using information from across. Europe Ecol. Model. 211, 209-223.

